

Austrotherm Fassadenprofile

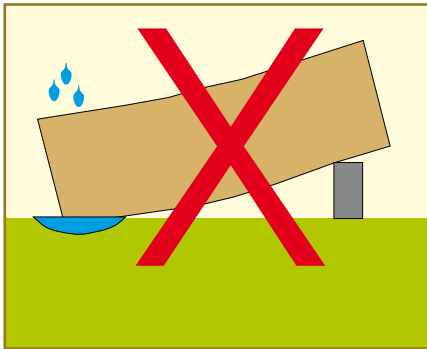

► **Sonderpreisliste**

Verarbeitungshinweise:



Lagerung:

- ▶ AUSTROTHERM Fassadenprofile werden im Karton verpackt ausgeliefert.
- ▶ Unbedingt auf stabilem, ebenem Untergrund lagern.
- ▶ Vor Feuchte, Nässe und großer Hitze schützen!

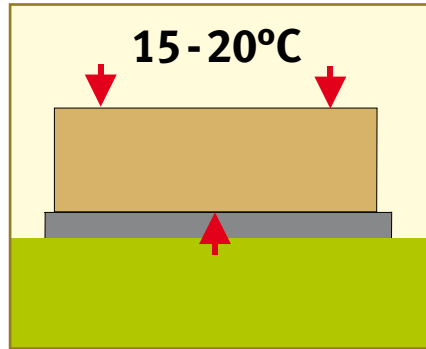

Verformung:

- ▶ Bei Verformung durch unsachgemäßen Transport oder Lagerung wie folgt vorgehen: Die verformten Profile kurz auf einem planen Untergrund bei einer Temperatur von zumindest 15°C (ev. mit einer Auflast) lagern.

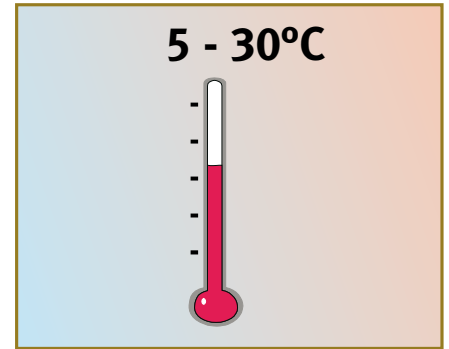

Verarbeitungstemperatur:

- ▶ Um eine dauerhafte Verklebung zu gewährleisten, ist auf die richtige Temperatur zu achten:
- ▶ Die Verarbeitungs- und Untergrundtemperatur darf nicht unter +5°C und über +30°C liegen.

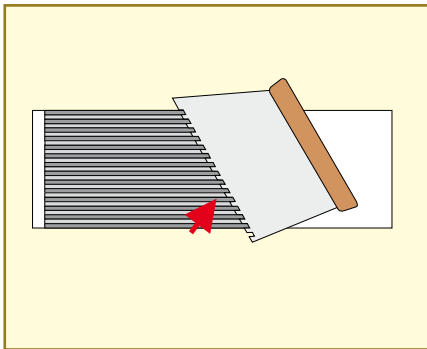

Befestigung:

- ▶ Aufkleben der Profile nur auf stabile, staub- und fettfreie Untergründe. Üblichen Fassadenkleber auf dem Untergrund der zu klebenden Flächen vollflächig mit einer Zahnpachtel auftragen. Die Verarbeitungsrichtlinien des Klebers beachten.

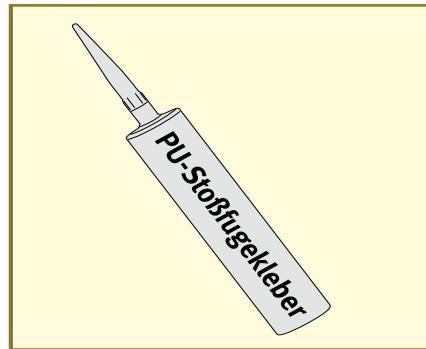

AUSTROTHERM PU-Stoßfugenkleber:

- ▶ Die Haftflächen müssen sauber sein. Glatte Haftflächen sind aufzurauben. Nach dem vollflächigen Auftragen des Austrotherm Stoßfugenklebers sollen die Materialien innerhalb von 5 Minuten zusammengesetzt werden. Die Klebeflächen sind gegen Verrutschen zu fixieren.

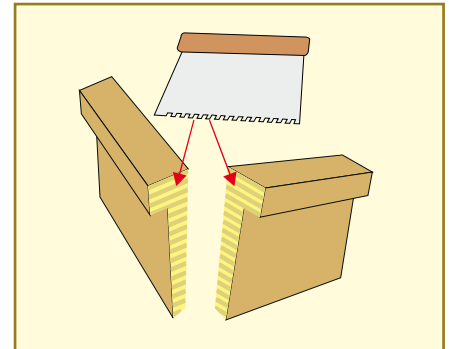

Profilstoß:

- ▶ Wichtig: Es ist besonders darauf zu achten, dass **beide Profilquerschnitte (Stirnseiten) vollflächig mit AUSTROTHERM PU-Stoßfugenkleber** versehen werden.

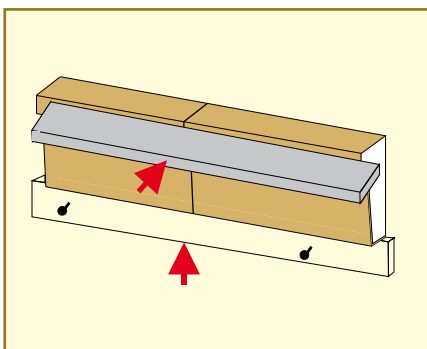

Profilausrichtung:

- ▶ Um eine exakte Ausrichtung der Profile zu erhalten, sollte mit einer Richtlatte gearbeitet werden. Bei größeren Profilen sollte zusätzlich eine gerade Latte an der Wand befestigt werden. Profile satt und fest andrücken.

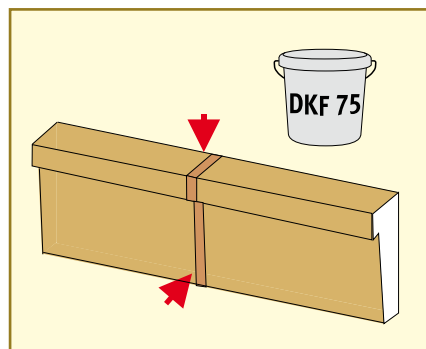

Nachbearbeitung:

- ▶ Denevtl. überquellenden Austrotherm PU-Stoßfugenkleber mit einer Spachtel entfernen. Nach Aushärtung des PU-Stoßfugenklebers ist die Oberfläche mit der hochflexiblen **Austrotherm Beschichtungsmasse DKF 75** zu verschließen. Dann kann die Oberfläche mit Schleifpapier nachbearbeitet werden.

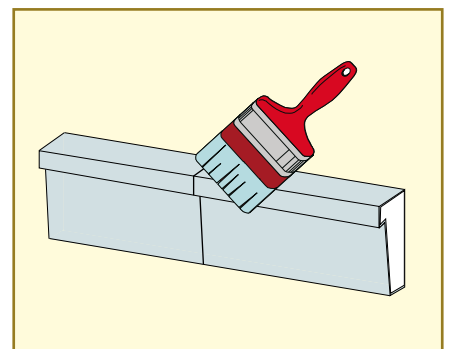

Farben:

- ▶ Nachdem alle Stöße nachbearbeitet wurden, kann Farbe aufgetragen werden. Die Fassadenfarbe auf Silikat-, Kunstharz-, bzw. Silikonbasis wird im Streich-, Roll- oder Spritzverfahren dünn-schichtig auf den staubfreien und trockenen Profilen aufgebracht.

Preisliste Austrotherm Fassadenprofile Sondersortiment

Inhalt

- ▶ Erläuterungen und allgemeine Informationen
- ▶ Preisblätter Austrotherm Fassadenprofile Sondersortiment
- ▶ Austrotherm Brettprofil
- ▶ Austrotherm Gesimse
- ▶ Austrotherm Nutprofil
- ▶ Austrotherm Sohlbank und Gurtprofil

Wie berechnet sich der Preis eines Austrotherm Sonderprofils?

Neben dem lagernden Standardsortiment hat Austrotherm ca. 3700 Fassadenprofile im Sondersortiment entwickelt. Diese werden auf Kundenwunsch in der gewünschten Laufmeteranzahl produziert. Der Listenpreis variiert je nach Laufmeter-Anzahl sowie nach der Profilbreite bzw. -höhe.

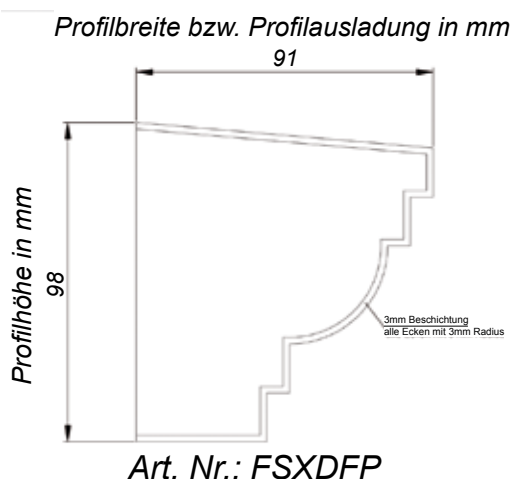

Profilbreite 91 x 98 mm Bedarf ca. 55 Laufmeter

Berechnungsbeispiel wie untenstehend oval markiert - **Liste € 25,97 / lfm. exkl. USt.**

Profilbreite in mm →

in €	10	20	30	40	50	60	70	80	90	100
10		16,58	17,15	17,71	18,28	18,85	19,42	19,99	20,55	21,12
20	16,58	16,58	17,15	17,71	18,28	18,85	19,42	19,99	20,55	21,12
30	16,95	16,95	17,54	18,14	18,73	19,33	19,92	20,52	21,12	21,71
40	17,32	17,32	17,95	18,57	19,19	19,81	20,44	21,06	21,68	22,30
50	17,70	17,70	18,35	19,00	19,65	20,30	20,95	21,60	22,25	22,90
60	18,09	18,09	18,77	19,44	20,12	20,80	21,48	22,15	22,83	23,51
70	18,48	18,48	19,18	19,89	20,59	21,30	22,00	22,71	23,41	24,12
80	18,88	18,88	19,61	20,34	21,07	21,80	22,53	23,27	24,00	24,73
90	19,28	19,28	20,04	20,80	21,55	22,31	23,07	23,83	24,59	25,35
100	19,68	19,68	20,47	21,26	22,04	22,83	23,62	24,40	25,19	25,97
110	20,10	20,10	20,91	21,72	22,56	23,48	24,41	24,98	25,79	26,60

↓
Profilhöhe in mm

Wenn notwendig, wird generell aufgerundet. Preise für Fassadenprofile mit einer Höhe oder Breite größer als 500 mm auf Anfrage.

Bei einer Menge über 100 lfm wenden Sie sich bitte an das Team Austrotherm Fassadenprofile für ein individuelles Angebot!



QR-Code einfach scannen und **Austrotherm Materiallisten-Generator** online nutzen.

Austrotherm GmbH, Am Kreuzweg 43, A-7423 Pinkafeld,
Tel.: +43 2633 401-347, Fax DW 370, fassadenprofile@austrotherm.at

Ab 100 lfm wenden Sie sich bitte an das Team Austrotherm Fassadenprofile für ein individuelles Angebot!
Status: Juni 2014. Fehler, Irrtümer und Änderungen vorbehalten.

Profillängen

- ▶ Gesimsprofile 2,50 lfm. / Stk.
- ▶ Rahmenprofile 2,50 lfm. / Stk.
- ▶ Sohlbankprofile 2,50 lfm. / Stk.
- ▶ Brettprofile 2,50 lfm. / Stk.
- ▶ Nutprofile 2,50 lfm. / Stk.

Produkte für den Stoßbereich

- ▶ Austrotherm PU Stoßfugenkleber (zur Vollflächigen Verklebung der Stoßfuge) 310 ml Kartusche
- ▶ Austrotherm Beschichtungsmasse DKF 75 (zur Stoßfugenausbildung) 1 kg-Kübel, 5 kg-Kübel

Hinweis: Eine Gewährleistung im Stoßfugenbereich erfolgt nur bei fachgerechter Verwendung bzw. Verarbeitung von Austrotherm PU-Stoßfugenkleber und Austrotherm Beschichtungsmasse DKF 75 (siehe Verarbeitungsrichtlinien).

Kosten Zusatzarbeiten

Ausführung	Einheit	Aufpreis exkl. MwSt.
Gehungsschnitt	je Schnitt	10%
Stirnseite beschichten	je Seite	15%
Stirnseite verkröpfen	je Seite	30%

Aufschlag in % basierend auf den Brutto Laufmeter-Preis des jeweiligen Profiltyps.
Anmerkung: Zusatzarbeiten sind nicht rabattierbar.

Individuelle Anfertigung

- ▶ Sonderanfertigung mit jeweiligen Detailskizzen möglich
- ▶ Preise und Lieferzeit auf Anfrage.

Alle Preise sind unverbindliche empfohlene Richtpreise in EURO exkl. MwSt. Druckfehler und Irrtümer vorbehalten. Status Dezember 2011, gilt bis auf Widerruf (siehe www.austrotherm.at)



Infos unter www.austrotherm.com

- ▶ Onlinesuche mit Download von dwg, pdf, Online-Listenpreisberechnung
- ▶ Bilder und Referenzfotos
- ▶ Download von Prospekten



QR-Code einfach scannen und **Austrotherm Materialisten-Generator** online nutzen.

Austrotherm GmbH, Am Kreuzweg 43, A-7423 Pinkafeld,
Tel.: +43 2633 401-347, Fax DW 370, fassadenprofile@austrotherm.at

Ab 100 lfm wenden Sie sich bitte an das Team Austrotherm Fassadenprofile für ein individuelles Angebot!
Status: Juni 2014. Fehler, Irrtümer und Änderungen vorbehalten.

Preisliste 0-20 lfm

Profilbreite in mm →

Profilhöhe
in mm ↓

in €	10	20	30	40	50	60	70	80	90	100
10		42,90	43,57	44,25	44,92	45,60	46,27	46,95	47,62	48,30
20	42,90	42,90	43,57	44,25	44,92	45,60	46,27	46,95	47,62	48,30
30	43,34	43,34	44,04	44,75	45,46	46,16	46,87	47,58	48,28	48,99
40	43,78	43,78	44,52	45,26	46,00	46,74	47,47	48,21	48,95	49,69
50	44,23	44,23	45,00	45,77	46,54	47,31	48,08	48,85	49,62	50,39
60	44,69	44,69	45,49	46,30	47,10	47,90	48,70	49,50	50,30	51,11
70	45,16	45,16	45,99	46,82	47,66	48,49	49,32	50,16	50,99	51,82
80	45,63	45,63	46,49	47,36	48,22	49,09	49,95	50,82	51,68	52,55
90	46,10	46,10	47,00	47,90	48,79	49,69	50,59	51,48	52,38	53,28
100	46,58	46,58	47,51	48,44	49,37	50,30	51,23	52,16	53,09	54,01
110	47,07	47,07	48,03	48,99	52,35	53,44	51,88	52,84	53,80	54,76
120	47,57	47,57	48,56	49,55	50,54	51,54	52,53	53,52	54,51	55,50
130	48,07	48,07	49,09	50,12	51,14	52,16	53,19	54,21	55,24	56,26
140	48,57	48,57	49,63	50,69	51,74	52,80	53,85	54,91	55,96	57,02
150	49,09	49,09	50,17	51,26	52,35	53,44	54,52	55,61	56,70	57,79
160	49,61	49,61	50,73	51,84	52,96	54,08	55,20	56,32	57,44	58,56
170	50,13	50,13	51,28	52,43	53,58	54,74	55,89	57,04	58,19	59,34
180	50,66	50,66	51,85	53,03	54,21	55,39	56,58	57,76	58,94	60,12
190	51,20	51,20	52,41	53,63	54,84	56,06	57,27	58,49	59,70	60,92
200	51,74	51,74	52,99	54,24	55,48	56,73	57,97	59,22	60,47	61,71
210	52,29	52,29	53,57	54,85	56,13	57,40	58,68	59,96	61,24	62,52
220	52,85	52,85	54,16	55,47	56,78	58,09	59,40	60,71	62,02	63,33
230	53,41	53,41	54,75	56,09	57,44	58,78	60,12	61,46	62,80	64,14
240	53,98	53,98	55,35	56,73	58,10	59,47	60,84	62,22	63,59	64,96
250	54,55	54,55	55,96	57,36	58,77	60,17	61,58	62,98	64,39	65,79
260	55,13	55,13	56,57	58,01	59,44	60,88	62,32	63,75	65,19	66,63
270	55,72	55,72	57,19	58,66	60,13	61,59	63,06	64,53	66,00	67,47
280	56,31	56,31	57,81	59,31	60,81	62,31	63,81	65,31	66,81	68,31
290	56,91	56,91	58,44	59,98	61,51	63,04	64,57	66,10	67,63	69,17
300	57,52	57,52	59,08	60,64	62,21	63,77	65,33	66,90	68,46	70,02
310	58,13	58,13	59,72	61,32	62,91	64,51	66,10	67,70	69,29	70,89
320	58,74	58,74	60,37	62,00	63,63	65,25	66,88	68,51	70,13	71,76
330	59,37	59,37	61,03	62,69	64,34	66,00	67,66	69,32	70,98	72,64
340	60,00	60,00	61,69	63,38	65,07	66,76	68,45	70,14	71,83	73,52
350	60,63	60,63	62,36	64,08	65,80	67,52	69,24	70,97	72,69	74,41
360	61,27	61,27	63,03	64,78	66,54	68,29	70,04	71,80	73,55	75,31
370	61,92	61,92	63,71	65,49	67,28	69,07	70,85	72,64	74,42	76,21
380	62,58	62,58	64,39	66,21	68,03	69,85	71,66	73,48	75,30	77,12
390	63,24	63,24	65,09	66,93	68,78	70,63	72,48	74,33	76,18	78,03
400	63,90	63,90	65,78	67,66	69,55	71,43	73,31	75,19	77,07	78,95
410	64,57	64,57	66,49	68,40	70,31	72,23	74,14	76,05	77,96	79,88
420	65,25	65,25	67,20	69,14	71,09	73,03	74,98	76,92	78,86	80,81
430	65,94	65,94	67,91	69,89	71,87	73,84	75,82	77,79	79,77	81,75
440	66,63	66,63	68,64	70,64	72,65	74,66	76,67	78,68	80,68	82,69
450	67,33	67,33	69,37	71,40	73,44	75,48	77,52	79,56	81,60	83,64
460	68,03	68,03	70,10	72,17	74,24	76,31	78,39	80,46	82,53	84,60
470	68,74	68,74	70,84	72,94	75,05	77,15	79,25	81,36	83,46	85,56
480	69,45	69,45	71,59	73,72	75,86	77,99	80,13	82,26	84,40	86,53
490	70,17	70,17	72,34	74,51	76,67	78,84	81,01	83,17	85,34	87,51
500	70,90	70,90	73,10	75,30	77,50	79,70	81,89	84,09	86,29	88,49



QR-Code einfach scannen und **Austrotherm Materiallisten-Generator** online nutzen.

Austrotherm GmbH, Am Kreuzweg 43, A-7423 Pinkafeld,
Tel.: +43 2633 401-347, Fax DW 370, fassadenprofile@austrotherm.at

Ab 100 lfm wenden Sie sich bitte an das Team Austrotherm Fassadenprofile für ein individuelles Angebot!
Status: Juni 2014. Fehler, Irrtümer und Änderungen vorbehalten.

Preisliste 0-20 lfm

Profilbreite in mm →

Profilhöhe
in mm



in €	110	120	130	140	150	160	170	180	190	200
10	48,97	49,65	50,32	51,00	51,67	52,35	53,02	53,70	54,37	55,05
20	48,97	49,65	50,32	51,00	51,67	52,35	53,02	53,70	54,37	55,05
30	49,70	50,40	51,11	51,82	52,52	53,23	53,94	54,64	55,35	56,06
40	50,43	51,17	51,90	52,64	53,38	54,12	54,86	55,60	56,33	57,07
50	51,16	51,94	52,71	53,48	54,25	55,02	55,79	56,56	57,33	58,10
60	51,91	52,71	53,51	54,31	55,12	55,92	56,72	57,52	58,32	59,12
70	52,66	53,49	54,32	55,16	55,99	56,83	57,66	58,49	59,33	60,16
80	53,41	54,28	55,14	56,01	56,87	57,74	58,60	59,47	60,34	61,20
90	54,18	55,07	55,97	56,87	57,76	58,66	59,56	60,45	61,35	62,25
100	54,94	55,87	56,80	57,73	58,66	59,59	60,52	61,44	62,37	63,30
110	55,72	56,68	57,64	58,60	59,56	60,52	61,48	62,44	63,40	64,36
120	56,50	57,49	58,48	59,47	60,47	61,46	62,45	63,44	64,43	65,43
130	57,28	58,31	59,33	60,36	61,38	62,40	63,43	64,45	65,47	66,50
140	58,08	59,13	60,19	61,24	62,30	63,35	64,41	65,47	66,52	67,58
150	58,87	59,96	61,05	62,14	63,22	64,31	65,40	66,49	67,57	68,66
160	59,68	60,80	61,92	63,04	64,16	65,27	66,39	67,51	68,63	69,75
170	60,49	61,64	62,79	63,94	65,09	66,24	67,40	68,55	69,70	70,85
180	61,31	62,49	63,67	64,85	66,04	67,22	68,40	69,59	70,77	71,95
190	62,13	63,34	64,56	65,77	66,99	68,20	69,42	70,63	71,84	73,06
200	62,96	64,20	65,45	66,70	67,94	69,19	70,44	71,68	72,93	74,17
210	63,79	65,07	66,35	67,63	68,91	70,18	71,46	72,74	74,02	75,29
220	64,64	65,95	67,25	68,56	69,87	71,18	72,49	73,80	75,11	76,42
230	65,48	66,82	68,17	69,51	70,85	72,19	73,53	74,87	76,21	77,56
240	66,34	67,71	69,08	70,46	71,83	73,20	74,58	75,95	77,32	78,69
250	67,20	68,60	70,01	71,41	72,82	74,22	75,63	77,03	78,44	79,84
260	68,06	69,50	70,94	72,37	73,81	75,25	76,68	78,12	79,56	80,99
270	68,93	70,40	71,87	73,34	74,81	76,28	77,74	79,21	80,68	82,15
280	69,81	71,31	72,81	74,31	75,81	77,31	78,81	80,31	81,81	83,31
290	70,70	72,23	73,76	75,29	76,82	78,36	79,89	81,42	82,95	84,48
300	71,59	73,15	74,72	76,28	77,84	79,41	80,97	82,53	84,10	87,08
310	72,48	74,08	75,68	77,27	78,87	80,46	82,06	83,65	86,67	88,26
320	73,39	75,01	76,64	78,27	79,90	81,52	83,15	84,78	87,82	89,45
330	74,30	75,96	77,61	79,27	80,93	82,59	84,25	87,33	88,98	90,64
340	75,21	76,90	78,59	80,28	81,97	83,66	85,35	88,46	90,15	91,84
350	76,13	77,86	79,58	81,30	83,02	84,74	87,88	89,61	91,33	93,05
360	77,06	78,81	80,57	82,32	84,08	85,83	89,00	90,76	92,51	94,26
370	77,99	79,78	81,57	83,35	85,14	88,34	90,13	91,91	93,70	95,48
380	78,93	80,75	82,57	84,39	86,20	89,44	91,26	93,07	94,89	96,71
390	79,88	81,73	83,58	85,43	87,28	90,54	92,39	94,24	96,09	97,94
400	80,83	82,71	84,59	86,47	89,77	91,65	93,53	95,42	97,30	99,18
410	81,79	83,70	85,61	87,53	90,86	92,77	94,68	96,60	98,51	100,42
420	82,75	84,70	86,64	90,00	91,95	93,89	95,84	97,78	99,73	101,67
430	83,72	85,70	87,68	91,07	93,05	95,02	97,00	98,97	100,95	102,93
440	84,70	86,71	88,72	92,14	94,15	96,16	98,17	100,17	102,18	104,19
450	85,68	87,72	91,18	93,22	95,26	97,30	99,34	101,38	103,42	105,46
460	86,67	88,74	92,23	94,30	96,37	98,45	100,52	102,59	104,66	106,73
470	87,67	89,77	93,29	95,39	97,50	99,60	101,70	103,81	105,91	108,01
480	88,67	90,80	94,35	96,49	98,62	100,76	102,89	105,03	107,16	109,30
490	89,67	93,26	95,43	97,59	99,76	101,93	104,09	106,26	108,42	110,59
500	90,69	94,30	96,50	98,70	100,90	103,10	105,30	107,49	109,69	117,04



QR-Code einfach scannen und **Austrotherm Materiallisten-Generator** online nutzen.

Austrotherm GmbH, Am Kreuzweg 43, A-7423 Pinkafeld,
Tel.: +43 2633 401-347, Fax DW 370, fassadenprofile@austrotherm.at

Ab 100 lfm wenden Sie sich bitte an das Team Austrotherm Fassadenprofile für ein individuelles Angebot!
Status: Juni 2014. Fehler, Irrtümer und Änderungen vorbehalten.

Preisliste 0-20 lfm

Profilbreite in mm →

Profilhöhe
in mm



in €	210	220	230	240	250	260	270	280	290	300
10	55,72	56,39	57,07	57,74	58,42	59,09	59,77	60,44	61,12	61,79
20	55,72	56,39	57,07	57,74	58,42	59,09	59,77	60,44	61,12	61,79
30	56,76	57,47	58,88	58,18	59,59	60,29	61,00	61,71	62,41	63,12
40	57,81	58,55	59,29	60,03	60,76	61,50	62,24	62,98	63,72	64,46
50	58,87	59,64	60,41	61,18	61,95	62,72	63,49	64,26	65,03	65,80
60	59,93	60,73	61,53	62,33	63,13	63,93	64,74	65,54	66,34	67,14
70	60,99	61,83	62,66	63,49	64,33	65,16	65,99	66,83	67,66	68,49
80	62,07	62,93	63,80	64,66	65,53	66,39	67,26	68,12	68,99	69,85
90	63,14	64,04	64,94	65,84	66,73	67,63	68,53	69,42	70,32	71,22
100	64,23	65,16	66,09	67,02	67,95	68,87	69,80	70,73	71,66	72,59
110	65,32	66,28	67,24	68,20	69,16	70,12	71,08	72,04	73,01	73,97
120	66,42	67,41	68,40	69,40	70,39	71,38	72,37	73,36	74,36	75,35
130	67,52	68,55	69,57	70,59	71,62	72,64	73,67	74,69	75,71	76,74
140	68,63	69,69	70,74	71,80	72,86	73,91	74,97	76,02	77,08	78,13
150	69,75	70,84	71,92	73,01	74,10	75,19	76,27	77,36	78,45	79,54
160	70,87	71,99	73,11	74,23	75,35	76,47	77,59	78,70	79,82	80,94
170	72,00	73,15	74,30	75,45	76,60	77,75	78,90	80,06	81,21	82,36
180	73,13	74,32	75,50	76,68	77,86	79,05	80,23	81,41	82,59	83,78
190	74,27	75,49	76,70	77,92	79,13	80,35	81,56	82,77	83,99	85,20
200	75,42	76,67	77,91	79,16	80,40	81,65	82,90	84,14	85,39	86,64
210	76,57	77,85	79,13	80,41	81,68	82,96	84,24	85,52	86,80	88,08
220	77,73	79,04	80,35	81,66	82,97	84,28	85,59	86,90	88,21	89,52
230	78,90	80,24	81,58	82,92	84,26	85,60	86,94	88,28	89,62	90,96
240	80,07	81,44	82,81	84,19	85,56	86,93	88,30	89,67	91,04	92,41
250	81,25	82,65	84,05	85,44	86,83	88,22	89,61	91,00	92,39	93,78
260	82,43	83,87	85,30	86,72	88,14	89,56	91,00	92,42	93,84	95,26
270	83,62	85,10	86,57	88,04	89,51	91,00	92,48	93,95	95,42	96,89
280	84,81	86,33	87,84	89,34	90,84	92,34	93,84	95,34	96,84	98,34
290	86,00	87,57	89,13	90,68	92,23	93,78	95,33	96,88	98,43	99,98
300	87,20	88,81	90,40	92,00	93,59	95,18	96,77	98,36	99,95	101,54
310	88,40	90,05	91,68	93,30	94,91	96,52	98,13	99,74	101,35	102,96
320	89,60	91,30	93,00	94,70	96,40	98,10	99,80	101,50	103,20	104,90
330	90,80	92,55	94,30	96,05	97,80	99,55	101,30	103,05	104,80	106,55
340	92,00	93,80	95,60	97,40	99,20	101,00	102,80	104,60	106,40	108,20
350	93,20	95,05	96,90	98,75	100,60	102,45	104,30	106,15	108,00	109,85
360	94,40	96,30	98,20	100,10	102,00	103,90	105,80	107,70	109,60	111,50
370	95,60	97,55	99,50	101,45	103,40	105,35	107,30	109,25	111,20	113,15
380	96,80	98,80	100,80	102,80	104,80	106,80	108,80	110,80	112,80	114,80
390	98,00	100,05	102,10	104,15	106,20	108,25	110,30	112,35	114,40	116,45
400	99,20	101,30	103,40	105,50	107,60	109,70	111,80	113,90	116,00	118,10
410	100,40	102,55	104,70	106,85	109,00	111,15	113,30	115,45	117,60	119,75
420	101,60	103,80	106,00	108,20	110,40	112,60	114,80	117,00	119,20	121,40
430	102,80	105,05	107,30	109,55	111,80	114,05	116,30	118,55	120,80	123,05
440	104,00	106,30	108,60	110,90	113,20	115,50	117,80	120,10	122,40	124,70
450	105,20	107,55	109,90	112,20	114,55	116,90	119,25	121,60	123,95	126,30
460	106,40	108,80	111,20	113,60	116,00	118,40	120,80	123,20	125,60	128,00
470	107,60	110,10	112,50	115,00	117,40	119,80	122,20	124,60	127,00	129,40
480	108,80	111,40	113,90	116,40	118,80	121,20	123,60	126,00	128,40	130,80
490	110,00	112,70	115,40	117,90	120,60	123,00	125,40	127,80	130,20	132,60
500	111,20	114,00	116,80	119,60	122,40	124,80	127,20	129,60	132,00	134,40



QR-Code einfach scannen und **Austrotherm Materiallisten-Generator** online nutzen.

Austrotherm GmbH, Am Kreuzweg 43, A-7423 Pinkafeld,
Tel.: +43 2633 401-347, Fax DW 370, fassadenprofile@austrotherm.at

Ab 100 lfm wenden Sie sich bitte an das Team Austrotherm Fassadenprofile für ein individuelles Angebot!
Status: Juni 2014. Fehler, Irrtümer und Änderungen vorbehalten.

Preisliste 0-20 lfm

Profilbreite in mm →

Profilhöhe
in mm



in €	310	320	330	340	350	360	370	380	390	400
10	62,47	63,14	63,82	64,49	65,17	65,84	66,52	67,19	67,87	68,54
20	62,47	63,14	63,82	64,49	65,17	65,84	66,52	67,19	67,87	68,54
30	63,83	64,53	65,24	65,95	66,65	67,36	68,07	68,77	69,48	70,19
40	65,19	65,93	66,67	67,41	68,15	68,88	69,62	70,36	71,10	71,84
50	66,57	67,34	68,11	68,88	69,65	70,42	71,19	71,96	72,73	73,50
60	67,94	68,75	69,55	70,35	71,15	71,95	72,75	73,56	74,36	75,16
70	69,33	70,16	70,99	71,83	72,66	73,50	74,33	75,16	76,00	76,83
80	70,72	71,58	72,45	73,31	74,18	75,04	75,91	76,77	77,64	78,51
90	72,11	73,01	73,91	74,81	75,70	76,60	77,50	78,39	79,29	80,19
100	73,52	74,45	75,37	76,30	77,23	78,16	79,09	80,02	80,95	81,88
110	74,93	75,89	76,85	77,81	78,77	79,73	80,69	81,65	82,61	83,57
120	76,34	77,33	78,33	79,32	80,31	81,30	82,29	83,29	84,28	85,27
130	77,76	78,79	79,81	80,83	81,86	82,88	83,91	84,93	85,95	86,98
140	79,19	80,25	81,30	82,36	83,41	84,47	85,52	86,58	87,63	88,69
150	80,62	81,71	82,80	83,88	84,97	86,06	87,15	88,23	89,32	91,83
160	82,06	83,18	84,30	85,42	86,54	87,66	90,20	91,31	92,43	93,55
170	83,51	84,66	85,81	86,96	89,53	90,68	91,83	92,98	94,13	95,28
180	84,96	86,14	88,74	89,93	91,11	92,29	93,47	94,66	95,84	97,02
190	87,84	89,05	90,26	91,48	92,69	93,91	95,12	96,34	97,55	98,77
200	89,30	90,55	91,79	93,04	94,28	95,53	96,78	98,02	99,27	100,51
210	90,77	92,05	93,33	94,60	95,88	97,16	98,44	99,71	100,99	102,27
220	92,25	93,56	94,87	96,17	97,48	98,79	100,10	101,41	102,72	104,03
230	93,73	95,07	96,41	97,75	99,09	100,44	101,78	103,12	104,46	105,80
240	95,22	96,59	97,96	99,34	100,71	102,08	103,46	104,83	106,20	107,57
250	96,71	98,12	99,52	100,93	102,33	103,74	105,14	106,55	107,95	109,36
260	98,21	99,65	101,09	102,52	103,96	105,40	106,83	108,27	114,86	116,29
270	99,72	101,19	102,66	104,12	105,59	107,06	108,53	115,15	116,62	118,09
280	101,23	102,73	104,23	105,73	107,23	108,73	115,39	116,89	118,39	119,89
290	102,75	104,28	105,82	107,35	114,03	115,56	117,09	118,63	120,16	121,69
300	104,28	105,84	107,40	114,12	115,68	117,25	118,81	120,37	121,94	123,50
310	105,81	107,40	114,15	115,75	117,34	118,94	120,53	120,37	123,72	125,32
320	107,35	114,13	115,75	117,38	119,01	120,63	122,26	123,89	125,51	127,14
330	114,04	115,70	117,36	119,02	120,68	122,34	123,99	125,65	127,31	128,97
340	115,59	117,28	118,97	120,66	122,35	124,04	125,74	127,43	129,12	130,81
350	117,15	118,87	120,59	122,31	124,04	125,76	127,48	129,20	130,93	132,65
360	118,71	120,46	122,22	123,97	125,73	127,48	129,23	130,99	132,74	134,50
370	120,28	122,06	123,85	125,64	127,42	129,21	130,99	132,78	134,56	136,35
380	121,85	123,67	125,49	127,31	129,12	130,94	132,76	134,58	136,39	138,21
390	123,43	125,28	127,13	128,98	130,83	132,68	134,53	136,38	138,23	140,08
400	125,02	126,90	128,78	130,66	132,54	134,42	136,31	138,19	140,07	141,95
410	126,61	128,53	130,44	132,35	134,26	136,18	138,09	140,00	141,91	143,83
420	128,21	130,16	132,10	134,05	135,99	137,93	139,88	141,82	143,77	145,71
430	129,82	131,79	133,77	135,75	137,72	139,70	141,67	143,65	145,63	147,60
440	131,43	133,44	135,44	137,45	139,46	141,47	143,48	145,48	147,49	149,50
450	133,05	135,09	137,12	139,16	141,20	143,24	145,28	147,32	149,36	151,40
460	134,67	136,74	138,81	140,88	142,95	145,03	147,10	149,17	151,24	164,25
470	136,30	138,40	140,50	142,61	144,71	146,81	148,92	151,02	164,06	166,16
480	137,93	140,07	142,20	144,34	146,47	148,61	150,74	163,82	165,95	168,09
490	139,58	141,74	143,91	146,08	148,24	150,41	152,58	165,68	167,85	170,01
500	141,22	143,42	145,62	147,82	150,02	152,22	165,35	167,55	169,75	171,95



QR-Code einfach scannen und **Austrotherm Materiallisten-Generator** online nutzen.

Austrotherm GmbH, Am Kreuzweg 43, A-7423 Pinkafeld,
Tel.: +43 2633 401-347, Fax DW 370, fassadenprofile@austrotherm.at

Ab 100 lfm wenden Sie sich bitte an das Team Austrotherm Fassadenprofile für ein individuelles Angebot!
Status: Juni 2014. Fehler, Irrtümer und Änderungen vorbehalten.

Preisliste 0-20 lfm

Profilbreite in mm →

Profilhöhe
in mm



in €	410	420	430	440	450	460	470	480	490	500
10	69,22	69,89	70,57	71,24	71,92	72,59	73,26	73,94	74,61	75,29
20	69,22	69,89	70,57	71,24	71,92	72,59	73,26	73,94	74,61	75,29
30	70,89	71,60	72,31	48,28	73,72	74,43	75,13	75,84	76,55	77,25
40	72,58	73,31	74,05	74,79	75,53	76,27	77,01	77,74	78,48	79,22
50	74,27	75,04	75,81	76,58	77,35	78,12	78,89	79,66	80,43	81,20
60	75,96	76,76	77,56	78,37	79,17	79,97	80,77	81,57	82,38	83,18
70	77,66	78,50	79,33	80,16	81,00	81,83	82,66	83,50	84,33	85,16
80	79,37	80,24	81,10	81,97	82,83	83,70	84,56	85,43	86,29	87,16
90	81,08	81,98	82,88	83,78	84,67	85,57	86,47	87,36	88,26	89,16
100	82,80	83,73	84,66	85,59	86,52	87,45	88,38	89,31	90,23	91,16
110	84,53	85,49	86,45	87,41	88,37	89,33	90,29	91,25	92,21	93,17
120	86,26	87,26	88,25	89,24	90,23	91,22	92,22	93,21	94,21	95,21
130	88,00	89,03	90,05	91,07	92,09	93,12	94,14	95,16	96,18	97,20
140	89,75	90,80	91,84	92,88	93,92	94,96	95,99	97,03	98,07	99,11
150	91,50	92,65	93,79	94,93	96,07	97,21	98,35	99,49	100,63	101,77
160	93,25	94,50	95,75	97,00	98,25	99,50	100,75	102,00	103,25	104,50
170	95,00	96,35	97,70	99,05	100,40	101,75	103,10	104,45	105,80	107,15
180	96,75	98,20	99,65	101,10	102,55	104,00	105,45	106,90	108,35	109,80
190	98,50	100,05	101,60	103,15	104,70	106,25	107,80	109,35	110,90	112,45
200	100,25	101,90	103,55	105,20	106,85	108,50	110,15	111,80	113,45	115,10
210	102,00	103,75	105,50	107,25	109,00	110,75	112,50	114,25	116,00	117,75
220	103,75	105,60	107,45	109,30	111,15	113,00	114,85	116,70	118,55	120,40
230	105,50	107,45	109,40	111,35	113,30	115,25	117,20	119,15	121,10	123,05
240	107,25	109,30	111,35	113,40	115,45	117,50	119,55	121,60	123,65	125,70
250	109,00	111,15	113,30	115,45	117,60	119,75	121,90	124,05	126,20	128,35
260	110,75	113,00	115,25	117,50	119,75	122,00	124,25	126,50	128,75	131,00
270	112,50	114,85	117,20	119,55	121,90	124,25	126,60	128,95	131,30	133,65
280	114,25	116,70	119,15	121,60	124,05	126,50	128,95	131,40	133,85	136,30
290	116,00	118,55	121,10	123,65	126,20	128,75	131,30	133,85	136,40	138,95
300	117,75	120,40	123,05	125,70	128,35	131,00	133,65	136,30	138,95	141,60
310	119,50	122,25	125,00	127,75	130,50	133,25	136,00	138,75	141,50	144,25
320	121,25	124,10	127,05	129,90	132,75	135,60	138,45	141,30	144,15	147,00
330	123,00	126,00	129,00	132,00	135,00	138,00	141,00	144,00	147,00	150,00
340	124,75	127,85	131,00	134,15	137,30	140,45	143,60	146,75	149,90	153,05
350	126,50	130,70	134,90	139,10	143,30	147,50	151,70	155,90	160,10	164,30
360	128,25	132,55	136,85	141,15	145,45	149,75	154,05	158,35	162,65	166,95
370	130,00	134,40	138,80	143,20	147,60	152,00	156,40	160,80	165,20	169,60
380	131,75	136,25	140,75	145,25	149,75	154,25	158,75	163,25	167,75	172,25
390	133,50	138,10	142,70	147,30	151,90	156,50	161,10	165,70	170,30	174,90
400	135,25	140,00	144,75	149,50	154,25	159,00	163,75	168,50	173,25	178,00
410	137,00	141,85	146,70	151,55	156,40	161,25	166,10	170,95	175,80	180,65
420	138,75	143,70	148,65	153,60	158,55	163,50	168,45	173,40	178,35	183,30
430	140,50	145,55	150,60	155,65	160,70	165,75	170,80	175,85	180,90	185,95
440	142,25	147,40	152,65	157,90	163,15	168,40	173,65	178,90	184,15	189,40
450	144,00	149,30	154,60	159,90	165,20	170,50	175,80	181,10	186,40	191,70
460	145,75	151,15	156,55	161,95	167,35	172,75	178,15	183,55	188,95	194,35
470	147,50	153,00	158,50	164,00	169,50	175,00	180,50	186,00	191,50	197,00
480	149,25	154,85	160,70	166,55	172,40	178,25	184,10	189,95	195,80	201,65
490	151,00	156,95	162,90	168,85	174,80	180,75	186,70	192,65	198,60	204,55
500	152,75	158,80	164,85	170,90	176,95	183,00	189,05	195,10	201,15	207,20



QR-Code einfach scannen und **Austrotherm Materiallisten-Generator** online nutzen.

Austrotherm GmbH, Am Kreuzweg 43, A-7423 Pinkafeld,
Tel.: +43 2633 401-347, Fax DW 370, fassadenprofile@austrotherm.at

Ab 100 lfm wenden Sie sich bitte an das Team Austrotherm Fassadenprofile für ein individuelles Angebot!
Status: Juni 2014. Fehler, Irrtümer und Änderungen vorbehalten.

Preisliste 21-50 lfm

Profilbreite in mm →

Profilhöhe
in mm



in €	10	20	30	40	50	60	70	80	90	100
10		24,36	24,96	25,55	26,15	26,74	27,34	27,93	28,53	29,12
20	24,36	24,36	24,96	25,55	26,15	26,74	27,34	27,93	28,53	29,12
30	24,75	24,75	25,37	26,00	26,62	27,24	27,87	28,49	29,11	29,74
40	25,14	25,14	25,80	26,45	27,10	27,75	28,40	29,05	29,71	30,36
50	25,54	25,54	26,22	26,90	27,58	28,26	28,94	29,62	30,30	30,98
60	25,95	25,95	26,65	27,36	28,07	28,78	29,49	30,20	30,90	31,61
70	26,36	26,36	27,09	27,83	28,57	29,30	30,04	30,78	31,51	32,25
80	26,77	26,77	27,53	28,30	29,07	29,83	30,60	31,36	32,13	32,89
90	27,19	27,19	27,98	28,78	29,57	30,36	31,16	31,95	32,74	33,54
100	27,62	27,62	28,44	29,26	30,08	30,90	31,72	32,55	33,37	34,19
110	28,05	28,05	28,90	29,75	32,71	33,68	32,30	33,15	34,00	34,85
120	28,48	28,48	29,36	30,24	31,12	32,00	32,87	33,75	34,63	35,51
130	28,92	28,92	29,83	30,74	31,64	32,55	33,46	34,37	35,27	36,18
140	29,37	29,37	30,31	31,24	32,18	33,11	34,05	34,98	35,92	36,85
150	29,82	29,82	30,79	31,75	32,71	33,68	34,64	35,60	36,57	37,53
160	30,28	30,28	31,27	32,26	33,26	34,25	35,24	36,23	37,22	38,22
170	30,74	30,74	31,76	32,78	33,81	34,83	35,85	36,87	37,89	38,91
180	31,21	31,21	32,26	33,31	34,36	35,41	36,46	37,50	38,55	39,60
190	31,69	31,69	32,76	33,84	34,92	35,99	37,07	38,15	39,23	40,30
200	32,17	32,17	33,27	34,38	35,48	36,59	37,69	38,80	39,90	41,01
210	32,65	32,65	33,78	34,92	36,05	37,19	38,32	39,45	40,59	41,72
220	33,14	33,14	34,30	35,47	36,63	37,79	38,95	40,11	41,28	42,44
230	33,64	33,64	34,83	36,02	37,21	38,40	39,59	40,78	41,97	43,16
240	34,14	34,14	35,36	36,58	37,79	39,01	40,23	41,45	42,67	43,89
250	34,64	34,64	35,89	37,14	38,39	39,63	40,88	42,13	43,37	44,62
260	35,16	35,16	36,43	37,71	38,98	40,26	41,53	42,81	44,08	45,36
270	35,67	35,67	36,98	38,28	39,58	40,89	42,19	43,50	44,80	46,10
280	36,20	36,20	37,53	38,86	40,19	41,52	42,86	44,19	45,52	46,85
290	36,72	36,72	38,08	39,44	40,81	42,17	43,53	44,89	46,25	47,61
300	37,26	37,26	38,65	40,03	41,42	42,81	44,20	45,59	46,98	48,37
310	37,80	37,80	39,21	40,63	42,05	43,47	44,88	46,30	47,72	49,13
320	38,34	38,34	39,79	41,23	42,68	44,12	45,57	47,01	48,46	49,91
330	38,89	38,89	40,36	41,84	43,31	44,79	46,26	47,73	49,21	50,68
340	39,44	39,44	40,95	42,45	43,95	45,45	46,96	48,46	49,96	51,46
350	40,00	40,00	41,54	43,07	44,60	46,13	47,66	49,19	50,72	52,25
360	40,57	40,57	42,13	43,69	45,25	46,81	48,37	49,93	51,48	53,04
370	41,14	41,14	42,73	44,32	45,90	47,49	49,08	50,67	52,25	53,84
380	41,72	41,72	43,33	44,95	46,57	48,18	49,80	51,41	53,03	54,65
390	42,30	42,30	43,94	45,59	47,23	48,88	50,52	52,17	53,81	55,51
400	42,89	42,89	44,56	46,23	47,91	49,58	51,25	52,92	54,60	56,33
410	43,48	43,48	45,18	46,88	48,58	50,28	51,98	53,69	55,39	57,15
420	44,08	44,08	45,81	47,54	49,27	51,00	52,72	54,45	56,24	57,97
430	44,68	44,68	46,44	48,20	49,95	51,71	53,47	55,23	57,05	58,80
440	45,29	45,29	47,08	48,86	50,65	52,43	54,22	56,01	57,85	59,64
450	45,91	45,91	47,72	49,53	51,35	53,16	54,98	56,79	58,67	60,48
460	46,52	46,52	48,37	50,21	52,05	53,90	55,74	57,64	59,54	61,33
470	47,15	47,15	49,02	50,89	52,76	54,63	56,51	58,44	60,44	62,18
480	47,78	47,78	49,68	51,58	53,48	55,38	57,28	59,24	61,24	63,04
490	48,42	48,42	50,34	52,27	54,20	56,13	58,06	60,04	62,04	63,97
500	49,06	49,06	51,01	52,97	54,93	56,88	58,84	60,86	62,86	64,81



QR-Code einfach scannen und **Austrotherm Materiallisten-Generator** online nutzen.

Austrotherm GmbH, Am Kreuzweg 43, A-7423 Pinkafeld,
Tel.: +43 2633 401-347, Fax DW 370, fassadenprofile@austrotherm.at

Ab 100 lfm wenden Sie sich bitte an das Team Austrotherm Fassadenprofile für ein individuelles Angebot!
Status: Juni 2014. Fehler, Irrtümer und Änderungen vorbehalten.

Preisliste 21-50 lfm

Profilbreite in mm →

Profilhöhe
in mm



in €	110	120	130	140	150	160	170	180	190	200
10	29,72	30,31	30,91	31,50	32,10	32,69	33,29	33,88	34,48	35,07
20	29,72	30,31	30,91	31,50	32,10	32,69	33,29	33,88	34,48	35,07
30	30,36	30,98	31,61	32,23	32,85	33,48	34,10	34,72	35,35	35,97
40	31,01	31,66	32,31	32,96	33,61	34,27	34,92	35,57	36,22	36,87
50	31,66	32,34	33,02	33,70	34,38	35,06	35,74	36,42	37,10	37,78
60	32,32	33,03	33,74	34,45	35,15	35,86	36,57	37,28	37,99	38,70
70	32,99	33,72	34,46	35,20	35,93	36,67	37,41	38,14	38,88	39,62
80	33,66	34,42	35,19	35,95	36,72	37,48	38,25	39,01	39,78	40,54
90	34,33	35,12	35,92	36,71	37,50	38,30	39,09	39,88	40,68	41,47
100	35,01	35,83	36,65	37,48	38,30	39,12	39,94	40,76	41,59	42,41
110	35,70	36,55	37,40	38,25	39,10	39,95	40,80	41,65	42,50	43,35
120	36,39	37,27	38,15	39,02	39,90	40,78	41,66	42,54	43,42	44,30
130	37,09	37,99	38,90	39,81	40,71	41,62	42,53	43,43	44,34	45,25
140	37,79	38,72	39,66	40,59	41,53	42,46	43,40	44,33	45,27	46,20
150	38,50	39,46	40,42	41,39	42,35	43,31	44,28	45,24	46,20	47,17
160	39,21	40,20	41,19	42,18	43,18	44,17	45,16	46,15	47,14	48,14
170	39,93	40,95	41,97	42,99	44,01	45,03	46,05	47,07	48,09	49,11
180	40,65	41,70	42,75	43,80	44,85	45,89	46,94	47,99	49,04	50,09
190	41,38	42,46	43,53	44,61	45,69	46,77	47,84	48,92	50,00	51,07
200	42,11	43,22	44,33	45,43	46,54	47,64	48,75	49,85	50,96	52,06
210	42,85	43,99	45,12	46,26	47,39	48,52	49,66	50,79	51,92	53,06
220	43,60	44,76	45,92	47,09	48,25	49,41	50,57	51,73	52,89	54,06
230	44,35	45,54	46,73	47,92	49,11	50,30	51,49	52,68	53,87	54,94
240	45,11	46,33	47,54	48,76	49,98	51,20	52,42	53,64	54,86	56,07
250	45,87	47,12	48,36	49,61	50,86	52,10	53,34	54,58	55,82	57,06
260	46,64	47,91	49,19	50,46	51,74	53,02	54,29	55,56	56,84	58,11
270	47,41	48,71	50,02	51,32	52,62	53,91	55,20	56,49	57,78	59,07
280	48,19	49,52	50,85	52,18	53,58	54,91	56,24	57,57	58,90	60,24
290	48,97	50,33	51,69	53,07	54,47	55,83	57,19	58,55	59,92	61,28
300	49,76	51,15	52,54	53,99	55,37	56,76	58,15	59,54	60,93	62,30
310	50,55	51,97	53,45	54,86	56,28	57,70	59,12	60,53	61,94	63,33
320	51,35	52,80	54,30	55,75	57,19	58,64	60,09	61,53	62,96	64,37
330	52,16	53,63	55,17	56,64	58,11	59,59	61,06	62,52	63,97	65,42
340	52,97	54,46	56,03	57,53	59,04	60,54	62,04	63,52	65,00	66,48
350	53,78	55,29	56,90	58,44	59,97	61,50	63,01	64,51	66,00	67,54
360	54,60	56,12	57,78	59,34	60,90	62,46	63,96	65,46	66,96	68,54
370	55,43	56,97	58,67	60,25	61,84	63,41	64,91	66,41	67,91	69,54
380	56,27	57,82	59,55	61,17	62,79	64,36	65,86	67,36	68,86	70,54
390	57,12	58,68	60,45	62,10	63,74	65,31	66,81	68,31	69,81	71,54
400	57,98	59,55	61,35	62,92	64,59	66,19	67,69	69,19	70,69	72,54
410	58,85	60,43	62,35	63,85	65,54	67,04	68,54	70,04	71,54	73,54
420	59,73	61,33	63,25	64,75	66,49	67,99	69,49	70,99	72,49	74,54
430	60,62	62,25	64,15	65,65	67,44	68,94	70,44	71,94	73,44	75,54
440	61,52	63,15	65,05	66,55	68,39	69,89	71,39	72,89	74,39	76,54
450	62,43	64,05	65,95	67,45	69,34	70,84	72,34	73,84	75,34	77,54
460	63,35	64,95	66,85	68,35	70,29	71,79	73,29	74,79	76,29	78,54
470	64,28	65,85	67,75	69,25	71,24	72,74	74,24	75,74	77,24	79,54
480	65,22	66,75	68,65	70,15	72,19	73,69	75,19	76,69	78,19	80,54
490	66,17	67,65	69,55	71,05	73,14	74,64	76,14	77,64	79,14	81,54
500	67,13	68,55	70,45	71,95	74,09	75,59	77,09	78,59	80,09	82,54



QR-Code einfach scannen und **Austrotherm Materiallisten-Generator** online nutzen.

Austrotherm GmbH, Am Kreuzweg 43, A-7423 Pinkafeld,
Tel.: +43 2633 401-347, Fax DW 370, fassadenprofile@austrotherm.at

Ab 100 lfm wenden Sie sich bitte an das Team Austrotherm Fassadenprofile für ein individuelles Angebot!
Status: Juni 2014. Fehler, Irrtümer und Änderungen vorbehalten.

Preisliste 21-50 lfm

Profilbreite in mm →

Profilhöhe
in mm



in €	210	220	230	240	250	260	270	280	290	300
10	35,67	36,26	36,86	37,45	38,05	38,64	39,24	39,83	40,43	41,02
20	35,67	36,26	36,86	37,45	38,05	38,64	39,24	39,83	40,43	41,02
30	36,59	37,22	38,46	37,84	39,09	39,71	40,33	40,96	41,58	42,20
40	37,52	38,18	38,83	39,48	40,13	40,78	41,43	42,09	42,74	43,39
50	38,46	39,14	39,82	40,50	41,18	41,86	42,54	43,22	43,90	44,58
60	39,40	40,11	40,82	41,53	42,24	42,95	43,65	44,36	45,07	45,78
70	40,35	41,09	41,83	42,56	43,30	44,04	44,77	45,51	46,25	46,98
80	41,31	42,07	42,84	43,60	44,37	45,13	45,90	46,66	47,43	48,19
90	42,26	43,06	43,85	44,65	45,44	46,23	47,03	47,82	48,61	49,41
100	43,23	44,05	44,87	45,69	46,52	47,34	48,16	48,98	49,80	50,63
110	44,20	45,05	45,90	46,75	47,60	48,45	49,30	50,15	51,00	51,85
120	45,17	46,05	46,93	47,81	48,69	49,57	50,44	51,32	52,20	53,08
130	46,15	47,06	47,97	48,87	49,78	50,69	51,60	52,50	53,41	54,32
140	47,14	48,08	49,01	49,95	50,88	51,82	52,75	53,69	56,68	57,62
150	48,13	49,09	50,06	51,02	51,99	52,95	53,91	56,94	57,90	58,86
160	49,13	50,12	51,11	52,10	53,10	56,15	57,14	58,13	59,12	60,12
170	50,13	51,15	52,17	53,19	56,27	57,29	58,31	59,33	60,35	61,37
180	51,14	52,19	55,30	56,34	57,39	58,44	59,49	60,54	61,59	62,64
190	52,15	55,29	56,37	57,44	58,52	59,60	60,67	61,75	62,83	63,90
200	55,23	56,33	57,44	58,55	59,65	60,76	61,86	62,97	64,07	67,46
210	56,25	57,39	58,52	59,65	60,79	61,92	63,06	66,47	67,61	68,74
220	57,28	58,44	59,61	60,77	61,93	63,09	66,54	67,70	68,86	70,03
230	58,32	59,51	60,70	61,89	63,08	66,55	67,74	68,93	70,12	71,32
240	59,36	60,58	61,79	63,01	66,52	67,73	68,95	70,17	71,39	72,61
250	60,40	61,65	62,90	66,43	67,67	68,92	70,17	71,42	72,66	73,91
260	61,45	62,73	66,29	67,56	68,84	70,11	71,39	72,67	73,94	75,22
270	62,51	66,10	67,40	68,70	70,01	71,31	72,62	73,92	75,22	76,53
280	65,85	67,19	68,52	69,85	71,18	72,52	73,85	75,18	76,51	77,84
290	66,92	68,28	69,64	71,00	72,36	73,72	75,08	76,45	77,81	79,17
300	67,99	69,38	70,77	72,16	73,55	74,94	76,33	77,72	79,10	80,49
310	69,07	70,49	71,91	73,32	74,74	76,16	77,57	78,99	80,41	83,89
320	70,15	71,60	73,04	74,49	75,94	77,38	78,83	80,27	83,78	85,23
330	71,24	72,72	74,19	75,66	77,14	78,61	80,09	83,62	85,10	86,57
340	72,34	73,84	75,34	76,84	78,35	79,85	83,41	84,91	86,42	87,92
350	73,43	74,97	76,50	78,03	79,56	81,09	84,68	86,21	87,74	89,27
360	74,54	76,10	77,66	79,22	80,78	84,40	85,96	87,51	89,07	90,63
370	75,65	77,24	78,82	80,41	84,06	85,65	87,24	88,82	90,41	92,00
380	76,76	78,38	80,00	83,67	85,29	86,91	88,52	90,14	91,75	93,37
390	77,89	79,53	81,17	84,88	86,52	88,17	89,81	91,46	93,10	94,74
400	79,01	80,68	84,42	86,09	87,76	89,44	91,11	92,78	94,45	96,13
410	80,14	81,84	85,61	87,31	89,01	90,71	92,41	94,11	95,81	97,51
420	81,28	85,07	86,80	88,53	90,26	91,99	93,72	95,45	97,18	98,91
430	84,48	86,24	88,00	89,76	91,51	93,27	95,03	96,79	98,54	100,30
440	85,63	87,42	89,20	90,99	92,78	94,56	96,35	98,13	99,92	101,71
450	86,78	88,60	90,41	92,23	94,04	95,86	97,67	99,49	101,30	103,11
460	87,94	89,79	91,63	93,47	95,31	97,16	99,00	100,84	102,69	104,53
470	89,11	90,98	92,85	94,72	96,59	98,46	100,33	102,20	104,08	105,95
480	90,28	92,18	94,08	95,97	97,87	99,77	101,67	103,57	105,47	109,43
490	91,45	93,38	95,31	97,23	99,16	101,09	103,02	104,95	108,93	110,86
500	92,63	94,59	96,54	98,50	100,46	102,41	104,37	106,32	110,34	112,30



QR-Code einfach scannen und **Austrotherm Materiallisten-Generator** online nutzen.

Austrotherm GmbH, Am Kreuzweg 43, A-7423 Pinkafeld,
Tel.: +43 2633 401-347, Fax DW 370, fassadenprofile@austrotherm.at

Ab 100 lfm wenden Sie sich bitte an das Team Austrotherm Fassadenprofile für ein individuelles Angebot!
Status: Juni 2014. Fehler, Irrtümer und Änderungen vorbehalten.

Preisliste 21-50 lfm

Profilbreite in mm →

Profilhöhe
in mm



in €	310	320	330	340	350	360	370	380	390	400
10	41,62	42,21	42,81	43,40	43,99	44,59	45,18	45,78	46,37	46,97
20	41,62	42,21	42,81	43,40	43,99	44,59	45,18	45,78	46,37	46,97
30	42,83	43,45	44,07	44,70	45,32	45,94	46,56	47,19	47,81	48,43
40	44,04	44,69	45,34	46,00	46,65	47,30	47,95	48,60	49,25	49,91
50	45,26	45,94	46,62	47,30	47,98	48,66	49,34	50,02	50,70	51,38
60	46,49	47,20	47,90	48,61	49,32	50,03	50,74	51,45	52,15	52,86
70	47,72	48,46	49,19	49,93	50,67	51,40	52,14	52,88	53,61	54,35
80	48,96	49,72	50,49	51,25	52,02	52,78	53,55	54,31	55,08	55,84
90	50,20	50,99	51,79	52,58	53,37	54,17	54,96	55,75	56,55	57,34
100	51,45	52,27	53,09	53,91	54,73	55,56	56,38	57,20	60,08	60,90
110	52,70	53,55	54,40	55,25	56,10	59,01	59,86	60,71	61,56	62,41
120	53,96	54,84	55,72	58,66	59,53	60,41	61,29	62,17	63,05	63,93
130	57,28	58,19	59,10	60,00	60,91	61,82	62,72	63,63	64,54	65,45
140	58,55	59,49	60,42	61,36	62,29	63,23	64,16	65,10	66,03	66,97
150	59,83	60,79	61,76	62,72	63,68	64,65	65,61	66,57	67,54	70,78
160	61,11	62,10	63,09	64,08	65,08	66,07	69,34	70,34	71,33	72,32
170	62,39	63,41	64,43	65,45	68,76	69,78	70,80	71,82	72,84	73,86
180	63,68	64,73	68,07	69,12	70,16	71,21	72,26	73,31	74,36	75,41
190	67,27	68,34	69,42	70,50	71,57	72,65	73,73	74,80	75,88	76,96
200	68,57	69,67	70,78	71,88	72,99	74,09	75,20	76,31	77,41	78,52
210	69,87	71,01	72,14	73,28	74,41	75,54	76,68	77,81	78,94	80,08
220	71,19	72,35	73,51	74,67	75,84	77,00	78,16	79,32	80,48	81,65
230	72,51	73,70	74,89	76,08	77,27	78,46	79,65	80,84	82,03	85,28
240	73,83	75,05	76,27	77,49	78,70	79,92	81,14	84,42	85,64	86,86
250	75,16	76,40	77,65	78,90	80,15	81,39	84,70	85,95	87,20	88,44
260	76,49	77,77	79,04	80,32	81,59	84,93	86,21	87,48	88,76	90,03
270	77,83	79,14	80,44	83,80	85,11	86,41	87,72	89,02	90,32	91,63
280	79,18	80,51	83,90	85,23	86,57	87,90	89,23	90,56	91,90	93,23
290	80,53	83,95	85,31	86,67	88,03	89,39	90,75	92,11	93,47	94,83
300	83,94	85,33	86,72	88,11	89,50	90,89	92,28	93,67	95,06	96,44
310	85,30	86,72	88,14	89,56	90,97	92,39	93,81	93,67	96,64	98,06
320	86,67	88,12	89,56	91,01	92,45	93,90	95,35	96,79	98,24	99,68
330	88,04	89,52	90,99	92,47	93,94	95,41	96,89	98,36	99,84	101,31
340	89,42	90,92	92,43	93,93	95,43	96,93	98,44	99,94	101,44	102,94
350	90,80	92,33	93,87	95,40	96,93	98,46	99,99	101,52	103,05	104,58
360	92,19	93,75	95,31	96,87	98,43	99,99	101,55	103,11	104,66	108,29
370	93,59	95,17	96,76	98,35	99,94	101,52	103,11	104,70	108,35	109,93
380	94,98	96,60	98,22	99,83	101,45	103,06	104,68	108,36	109,97	111,59
390	96,39	98,03	99,68	101,32	102,97	104,61	108,32	109,96	111,60	113,25
400	97,80	99,47	101,14	102,82	104,49	108,22	109,89	111,57	113,24	114,91
410	99,21	100,91	102,62	104,32	108,08	109,78	111,48	113,18	114,88	116,58
420	100,63	102,36	104,09	107,88	109,61	111,34	113,07	114,80	116,53	118,26
430	102,06	103,82	105,58	109,39	111,15	112,91	114,67	116,42	118,18	119,94
440	103,49	105,28	109,12	110,91	112,70	114,48	116,27	118,05	119,84	121,63
450	104,93	108,80	110,62	112,43	114,25	116,06	117,88	119,69	121,50	123,32
460	108,43	110,27	112,12	113,96	115,80	117,65	119,49	121,33	123,17	135,26
470	109,88	111,75	113,62	115,49	117,36	119,23	121,11	122,98	135,10	136,97
480	111,33	113,23	115,13	117,03	118,93	120,83	122,73	134,88	136,78	138,67
490	112,79	114,72	116,65	118,57	120,50	122,43	124,36	136,53	138,46	142,45
500	114,25	116,21	118,17	120,12	122,08	124,04	136,24	138,19	142,21	144,17



QR-Code einfach scannen und **Austrotherm Materiallisten-Generator** online nutzen.

Austrotherm GmbH, Am Kreuzweg 43, A-7423 Pinkafeld,
Tel.: +43 2633 401-347, Fax DW 370, fassadenprofile@austrotherm.at

Ab 100 lfm wenden Sie sich bitte an das Team Austrotherm Fassadenprofile für ein individuelles Angebot!
Status: Juni 2014. Fehler, Irrtümer und Änderungen vorbehalten.

Preisliste 21-50 lfm

Profilbreite in mm →

Profilhöhe
in mm



in €	410	420	430	440	450	460	470	480	490	500
10	47,56	48,16	48,75	49,35	49,94	50,54	51,13	51,73	52,32	52,92
20	47,56	48,16	48,75	49,35	49,94	50,54	51,13	51,73	52,32	52,92
30	49,06	49,68	50,30	29,11	51,55	52,17	52,80	53,42	54,04	54,67
40	50,56	51,21	51,86	52,51	53,16	53,82	54,47	55,12	55,77	56,42
50	52,06	52,74	53,42	54,10	54,78	55,46	56,14	56,82	57,50	58,18
60	53,57	54,28	54,99	55,70	56,40	57,11	57,82	58,53	59,24	59,95
70	55,09	55,82	56,56	57,30	58,03	58,77	59,51	60,24	60,98	61,72
80	56,61	57,37	58,14	58,90	59,67	62,49	63,26	64,02	64,79	65,55
90	58,13	60,99	61,78	62,57	63,37	64,16	64,95	65,75	66,54	67,33
100	61,73	62,55	63,37	64,19	65,01	65,83	66,66	67,48	68,30	69,12
110	63,26	64,11	64,96	65,81	66,66	67,51	68,36	69,21	70,06	70,91
120	64,80	65,68	66,56	67,44	68,32	69,20	70,08	70,95	74,12	75,00
130	66,35	67,26	68,17	69,07	72,26	73,17	74,08	74,98	75,89	76,80
140	67,91	71,13	72,06	73,00	73,93	74,87	75,80	76,74	77,67	78,61
150	71,75	72,71	73,68	74,64	75,60	76,57	77,53	78,49	79,46	80,42
160	73,31	74,30	75,30	76,29	77,28	78,27	79,26	80,26	81,25	82,24
170	74,88	75,90	76,92	77,94	78,96	79,98	81,00	82,02	83,04	84,06
180	76,46	77,50	78,55	79,60	80,65	81,70	82,75	83,80	84,85	87,95
190	78,04	79,11	80,19	81,27	82,34	83,42	84,50	87,64	88,71	89,79
200	79,62	80,73	81,83	82,94	86,10	87,21	88,31	89,42	90,53	91,63
210	81,21	82,35	85,54	86,67	87,81	88,94	90,08	91,21	92,34	93,48
220	82,81	86,03	87,19	88,36	89,52	90,68	91,84	93,00	94,17	95,33
230	86,47	87,66	88,85	90,04	91,23	92,42	93,61	94,80	95,99	97,19
240	88,08	89,30	90,52	91,73	92,95	94,17	95,39	96,61	97,83	99,05
250	89,69	90,94	92,18	93,43	94,68	95,93	97,17	98,42	99,67	100,92
260	91,31	92,58	93,86	95,13	96,41	97,69	98,96	100,24	101,51	102,79
270	92,93	94,24	95,54	96,84	98,15	99,45	100,75	102,06	103,36	104,67
280	94,56	95,89	97,22	98,56	99,89	101,22	102,55	103,89	105,22	106,55
290	96,19	97,55	98,92	100,28	101,64	103,00	104,36	105,72	109,14	110,50
300	97,83	99,22	100,61	102,00	103,39	104,78	106,17	109,62	111,01	112,40
310	99,48	100,90	102,31	103,73	105,15	108,63	110,04	111,46	112,88	114,30
320	101,13	102,57	104,02	105,47	108,97	110,42	111,86	113,31	114,75	116,20
330	102,78	104,26	105,73	109,27	110,74	112,22	113,69	115,16	116,64	118,11
340	104,45	108,01	109,51	111,01	112,52	114,02	115,52	117,02	118,53	120,03
350	108,17	109,70	111,23	112,76	114,30	115,83	117,36	118,89	120,42	121,95
360	109,84	111,40	112,96	114,52	116,08	117,64	119,20	120,76	122,32	123,88
370	111,52	113,11	114,70	116,28	117,87	119,46	121,05	122,63	124,22	136,06
380	113,20	114,82	116,44	118,05	119,67	121,28	122,90	134,76	136,38	137,99
390	114,89	116,54	118,18	119,82	121,47	123,11	135,00	136,65	138,29	142,00
400	116,59	118,26	119,93	121,60	123,28	135,20	136,87	138,54	142,27	143,95
410	118,28	119,99	121,69	123,39	135,34	137,04	138,74	142,50	144,20	145,90
420	119,99	121,72	123,45	135,42	137,15	138,88	142,67	144,40	146,13	147,86
430	121,70	123,46	135,46	137,22	138,98	142,79	144,55	146,31	148,07	149,83
440	123,41	135,45	137,23	139,02	142,87	144,65	146,44	148,22	150,01	151,80
450	135,38	137,19	139,01	142,88	144,70	146,51	148,33	150,14	151,96	153,77
460	137,11	138,95	142,85	144,70	146,54	148,38	150,22	152,07	153,91	155,75
470	138,84	142,77	144,64	146,51	148,38	150,25	152,13	154,00	155,87	157,74
480	142,64	144,53	146,43	148,33	150,23	152,13	154,03	155,93	157,83	159,73
490	144,38	146,30	148,23	150,16	152,09	154,02	155,94	157,87	159,80	161,73
500	146,12	148,08	150,04	151,99	153,95	155,91	157,86	159,82	161,77	165,79



QR-Code einfach scannen und **Austrotherm Materiallisten-Generator** online nutzen.

Austrotherm GmbH, Am Kreuzweg 43, A-7423 Pinkafeld,
Tel.: +43 2633 401-347, Fax DW 370, fassadenprofile@austrotherm.at

Ab 100 lfm wenden Sie sich bitte an das Team Austrotherm Fassadenprofile für ein individuelles Angebot!
Status: Juni 2014. Fehler, Irrtümer und Änderungen vorbehalten.

Preisliste 51-100 lfm

Profilbreite in mm →

Profilhöhe
in mm



in €	10	20	30	40	50	60	70	80	90	100
10		16,58	17,15	17,71	18,28	18,85	19,42	19,99	20,55	21,12
20	16,58	16,58	17,15	17,71	18,28	18,85	19,42	19,99	20,55	21,12
30	16,95	16,95	17,54	18,14	18,73	19,33	19,92	20,52	21,12	21,71
40	17,32	17,32	17,95	18,57	19,19	19,81	20,44	21,06	21,68	22,30
50	17,70	17,70	18,35	19,00	19,65	20,30	20,95	21,60	22,25	22,90
60	18,09	18,09	18,77	19,44	20,12	20,80	21,48	22,15	22,83	23,51
70	18,48	18,48	19,18	19,89	20,59	21,30	22,00	22,71	23,41	24,12
80	18,88	18,88	19,61	20,34	21,07	21,80	22,53	23,27	24,00	24,73
90	19,28	19,28	20,04	20,80	21,55	22,31	23,07	23,83	24,59	25,35
100	19,68	19,68	20,47	21,26	22,04	22,83	23,62	24,40	25,19	25,97
110	20,10	20,10	20,91	21,72	24,56	25,48	24,16	24,98	25,79	26,60
120	20,51	20,51	21,35	22,19	23,03	23,88	24,72	25,56	26,40	27,24
130	20,93	20,93	21,80	22,67	23,54	24,41	25,27	26,14	27,01	27,88
140	21,36	21,36	22,26	23,15	24,05	24,94	25,84	26,73	27,63	28,52
150	21,79	21,79	22,72	23,64	24,56	25,48	26,41	27,33	28,25	29,17
160	22,23	22,23	23,18	24,13	25,08	26,03	26,98	27,93	28,88	29,83
170	22,67	22,67	23,65	24,63	25,60	26,58	27,56	28,53	29,51	30,49
180	23,12	23,12	24,13	25,13	26,13	27,14	28,14	29,15	30,15	31,15
190	23,57	23,57	24,61	25,64	26,67	27,70	28,73	29,76	30,79	32,85
200	24,03	24,03	25,09	26,15	27,21	28,27	29,32	30,38	31,44	33,53
210	24,50	24,50	25,58	26,67	27,75	28,84	29,92	31,01	33,13	34,21
220	24,96	24,96	26,08	27,19	28,30	29,42	30,53	31,64	33,78	34,90
230	25,44	25,44	26,58	27,72	28,86	30,00	31,14	33,31	34,45	35,59
240	25,92	25,92	27,08	28,25	29,42	30,59	31,75	33,95	35,12	36,29
250	26,40	26,40	27,59	28,79	29,98	31,18	33,40	34,60	35,79	36,99
260	26,89	26,89	28,11	29,33	30,55	31,78	34,03	35,25	36,47	37,69
270	27,38	27,38	28,63	29,88	31,13	32,38	34,66	35,91	37,16	38,41
280	27,88	27,88	29,16	30,43	31,71	34,02	35,29	36,57	37,85	39,12
290	28,39	28,39	29,69	30,99	32,30	34,63	35,93	37,24	38,54	39,85
300	28,90	28,90	30,23	31,56	32,89	35,25	36,58	37,91	39,24	40,57
310	29,41	29,41	30,77	32,13	33,48	35,87	37,23	38,59	39,95	41,31
320	29,93	29,93	31,32	32,70	35,12	36,50	37,89	39,27	40,66	42,04
330	30,46	30,46	31,87	33,28	35,72	37,14	38,55	39,96	41,37	42,79
340	30,99	30,99	32,43	33,86	36,34	37,77	39,21	40,65	42,09	43,53
350	31,52	31,52	32,99	34,45	36,95	38,42	39,89	41,35	42,82	44,29
360	32,06	32,06	33,56	35,05	37,57	39,07	40,56	42,06	43,55	45,05
370	32,61	32,61	34,13	35,65	38,20	39,72	41,24	42,77	44,29	45,81
380	33,16	33,16	34,71	36,25	38,83	40,38	41,93	43,48	45,03	46,58
390	33,71	33,71	35,29	36,87	39,47	41,05	42,62	44,20	45,78	47,35
400	34,27	34,27	35,88	37,48	40,11	41,72	43,32	44,92	46,53	48,13
410	34,84	34,84	36,47	38,10	40,76	42,39	44,02	45,65	47,28	49,94
420	35,41	35,41	37,07	38,73	41,42	43,07	44,73	46,39	48,05	50,73
430	35,99	35,99	37,67	39,36	42,07	43,76	45,44	47,13	48,81	51,53
440	36,57	36,57	38,28	39,99	42,74	44,45	46,16	47,87	49,59	52,33
450	37,16	37,16	38,90	40,64	43,41	45,14	46,88	48,62	51,39	53,13
460	37,75	37,75	39,52	41,28	44,08	45,85	47,61	49,38	52,18	53,94
470	38,35	38,35	40,14	41,93	44,76	46,55	48,35	50,14	52,96	54,76
480	38,95	38,95	40,77	42,59	45,44	47,26	49,08	50,90	53,76	55,58
490	39,56	39,56	41,40	43,25	46,13	47,98	49,83	52,71	54,55	56,40
500	40,17	40,17	42,04	43,92	46,83	48,70	50,58	53,48	55,36	57,23



QR-Code einfach scannen und **Austrotherm Materiallisten-Generator** online nutzen.

Austrotherm GmbH, Am Kreuzweg 43, A-7423 Pinkafeld,
Tel.: +43 2633 401-347, Fax DW 370, fassadenprofile@austrotherm.at

Ab 100 lfm wenden Sie sich bitte an das Team Austrotherm Fassadenprofile für ein individuelles Angebot!
Status: Juni 2014. Fehler, Irrtümer und Änderungen vorbehalten.

Preisliste 51-100 lfm

Profilbreite in mm →

Profilhöhe
in mm



in €	110	120	130	140	150	160	170	180	190	200
10	21,69	22,26	22,83	23,40	23,96	24,53	25,10	25,67	26,24	26,81
20	21,69	22,26	22,83	23,40	23,96	24,53	25,10	25,67	26,24	26,81
30	22,31	22,90	23,50	24,09	24,69	25,28	25,88	26,48	27,07	27,67
40	22,93	23,55	24,17	24,80	25,42	26,04	26,66	27,29	27,91	28,53
50	23,55	24,20	24,85	25,50	26,15	26,80	27,45	28,10	28,75	29,40
60	24,18	24,86	25,54	26,22	26,89	27,57	28,25	28,92	29,60	30,28
70	24,82	25,52	26,23	26,93	27,64	28,34	29,05	29,75	30,46	31,16
80	25,46	26,19	26,92	27,66	28,39	29,12	29,85	30,58	31,31	32,05
90	26,11	26,87	27,63	28,38	29,14	29,90	30,66	31,42	32,18	32,94
100	26,76	27,55	28,33	29,12	29,90	30,69	31,48	32,26	34,08	34,87
110	27,42	28,23	29,04	29,86	30,67	31,48	32,30	34,14	34,95	35,77
120	28,08	28,92	29,76	30,60	31,44	33,31	34,15	34,99	35,83	36,67
130	28,75	29,61	30,48	31,35	33,25	34,11	34,98	35,85	36,72	37,59
140	29,42	30,31	31,21	33,13	34,03	34,92	35,82	36,71	37,61	38,50
150	30,09	31,02	32,97	33,89	34,81	35,74	36,66	37,58	38,50	39,43
160	30,78	32,76	33,71	34,66	35,61	36,56	37,50	38,45	39,40	40,35
170	31,46	33,47	34,45	35,43	36,40	37,38	38,36	39,33	40,31	41,29
180	33,19	34,19	35,20	36,20	37,20	38,21	39,21	40,22	41,22	42,22
190	33,89	34,92	35,95	36,98	38,01	39,04	40,07	41,10	42,14	43,17
200	34,59	35,65	36,71	37,76	38,82	39,88	40,94	42,00	43,06	44,12
210	35,30	36,38	37,47	38,55	39,64	40,73	41,81	42,90	43,98	45,07
220	36,01	37,12	38,24	39,35	40,46	41,58	42,69	43,80	44,91	47,06
230	36,73	37,87	39,01	40,15	41,29	42,43	43,57	44,71	46,88	48,02
240	37,45	38,62	39,79	40,96	42,12	43,29	44,46	45,62	47,82	48,99
250	38,18	39,38	40,57	41,77	42,96	44,16	45,35	47,57	48,77	49,96
260	38,92	40,14	41,36	42,58	43,80	45,03	47,28	48,50	49,72	50,94
270	39,66	40,90	42,15	43,40	44,65	45,90	48,18	49,43	50,68	51,93
280	40,40	41,68	42,95	44,23	45,50	47,81	49,09	50,36	51,64	52,92
290	41,15	42,45	43,76	45,06	47,39	48,70	50,00	51,30	52,61	53,91
300	41,90	43,23	44,57	45,90	48,26	49,59	50,92	52,25	53,58	57,14
310	42,66	44,02	45,38	47,77	49,13	50,48	51,84	53,20	56,79	58,14
320	43,43	44,81	46,20	48,61	50,00	51,39	52,77	54,16	57,77	59,15
330	44,20	45,61	48,05	49,47	50,88	52,29	53,70	57,34	58,76	60,17
340	44,97	46,41	48,88	50,32	51,76	53,20	54,64	58,31	59,75	61,19
350	45,75	48,25	49,72	51,19	52,65	54,12	57,81	59,28	60,75	63,25
360	46,54	49,06	50,56	52,05	53,55	55,04	58,76	60,26	61,75	64,28
370	47,33	49,88	51,40	52,92	54,45	58,20	59,72	61,24	63,79	65,31
380	49,16	50,71	52,25	53,80	55,35	59,13	60,68	62,22	64,80	66,35
390	49,96	51,53	53,11	54,69	56,26	60,06	61,64	64,25	65,82	67,40
400	50,76	52,37	53,97	55,57	59,40	61,01	62,61	65,24	66,85	68,45
410	51,57	53,21	54,84	56,47	60,32	61,95	64,62	66,25	67,88	69,51
420	52,39	54,05	55,71	59,59	61,25	62,91	65,60	67,25	68,91	70,57
430	53,21	54,90	56,58	60,50	62,18	64,90	66,58	68,26	69,95	71,63
440	54,04	55,75	57,46	61,40	63,12	65,86	67,57	69,28	70,99	72,71
450	54,87	56,61	60,58	62,32	65,09	66,83	68,57	70,30	72,04	73,78
460	55,71	57,48	61,47	63,24	66,03	67,80	69,57	71,33	73,10	74,87
470	56,55	58,34	62,37	64,16	66,98	68,78	70,57	72,37	74,16	75,95
480	57,40	59,22	63,27	66,12	67,94	69,76	71,58	73,40	75,22	78,08
490	58,25	62,33	64,18	67,05	68,90	70,75	72,60	74,45	76,29	79,17
500	59,11	63,21	65,09	67,99	69,87	71,74	73,62	75,49	78,40	80,28



QR-Code einfach scannen und **Austrotherm Materiallisten-Generator** online nutzen.

Austrotherm GmbH, Am Kreuzweg 43, A-7423 Pinkafeld,
Tel.: +43 2633 401-347, Fax DW 370, fassadenprofile@austrotherm.at

Ab 100 lfm wenden Sie sich bitte an das Team Austrotherm Fassadenprofile für ein individuelles Angebot!
Status: Juni 2014. Fehler, Irrtümer und Änderungen vorbehalten.

Preisliste 51-100 lfm

Profilbreite in mm →

Profilhöhe
in mm



in €	210	220	230	240	250	260	270	280	290	300
10	27,37	27,94	28,51	29,08	29,65	30,22	30,78	31,35	31,92	32,49
20	27,37	27,94	28,51	29,08	29,65	30,22	30,78	31,35	31,92	32,49
30	28,26	28,86	29,45	30,05	30,64	31,24	31,83	32,43	33,03	33,62
40	29,15	29,78	30,40	31,02	31,65	32,27	32,89	33,51	34,14	34,76
50	30,05	30,70	31,35	32,00	32,65	33,30	33,95	34,60	35,25	35,90
60	30,96	31,63	32,31	32,99	33,66	34,34	35,02	36,73	37,40	38,08
70	31,86	32,57	33,27	33,98	35,71	36,42	37,12	37,83	38,53	39,23
80	32,78	33,51	35,27	36,00	36,74	37,47	38,20	38,93	39,66	40,39
90	34,73	35,49	36,25	37,00	37,76	38,52	39,28	40,04	40,80	41,56
100	35,65	36,44	37,22	38,01	38,80	39,58	40,37	41,15	41,94	42,73
110	36,58	37,39	38,21	39,02	39,83	40,65	41,46	42,27	43,09	43,90
120	37,51	38,36	39,20	40,04	40,88	41,72	42,56	43,40	44,24	45,08
130	38,45	39,32	40,19	41,06	41,93	42,79	43,66	44,53	45,40	46,26
140	39,40	40,29	41,19	42,08	42,98	43,87	44,77	45,66	46,56	47,45
150	40,35	41,27	42,19	43,12	44,04	44,96	45,88	46,80	48,76	49,68
160	41,30	42,25	43,20	44,15	45,10	46,05	47,00	48,98	49,93	50,88
170	42,26	43,24	44,22	45,19	46,17	48,18	49,15	50,13	51,11	52,08
180	43,23	44,23	45,24	46,24	48,27	49,28	50,28	51,29	52,29	53,29
190	44,20	45,23	47,29	48,32	49,35	50,38	51,42	52,45	53,48	54,51
200	45,17	47,26	48,32	49,38	50,44	51,50	52,56	53,61	54,67	57,96
210	47,18	48,27	49,36	50,44	51,53	52,61	53,70	57,01	58,10	59,18
220	48,17	49,28	50,40	51,51	52,62	53,74	57,08	58,19	59,30	60,41
230	49,16	50,30	51,44	52,58	53,72	57,09	58,23	59,37	60,51	61,65
240	50,16	51,32	52,49	53,66	57,05	58,22	59,39	60,56	62,75	63,92
250	51,16	52,35	53,55	56,97	58,16	59,36	60,55	62,78	63,97	65,17
260	52,17	53,39	56,84	58,06	59,28	60,50	62,75	63,98	65,20	66,42
270	53,18	56,65	57,90	59,15	60,40	62,68	63,93	65,18	66,43	67,68
280	56,42	57,70	58,97	60,25	62,56	63,83	65,11	66,39	67,66	68,94
290	57,44	58,75	60,05	62,38	63,69	64,99	66,29	67,60	68,90	70,21
300	58,47	59,80	61,13	63,49	64,82	66,15	67,48	68,82	70,15	71,48
310	59,50	60,86	63,25	64,61	65,96	67,32	68,68	70,04	71,40	72,75
320	60,54	62,95	64,34	65,73	67,11	68,50	69,88	71,27	72,65	74,04
330	62,61	64,02	65,44	66,85	68,26	69,67	71,09	72,50	73,91	76,35
340	63,66	65,10	66,54	67,98	69,42	70,86	72,30	73,74	76,21	77,65
350	64,71	66,18	67,65	69,11	70,58	72,05	73,51	76,01	77,48	78,95
360	65,77	67,26	68,76	70,25	71,75	73,24	75,77	77,26	78,75	80,25
370	66,83	68,35	69,88	71,40	72,92	75,47	76,99	78,51	80,04	81,56
380	67,90	69,45	71,00	72,55	74,10	76,68	78,22	79,77	81,32	82,87
390	68,97	70,55	72,13	73,70	76,31	77,88	79,46	81,04	82,61	84,19
400	70,05	71,66	73,26	75,89	77,50	79,10	80,70	82,31	83,91	85,51
410	71,14	72,77	74,40	77,06	78,69	80,32	81,95	83,58	85,21	87,87
420	72,23	73,88	76,57	78,23	79,89	81,56	83,20	84,86	86,52	89,20
430	73,32	75,00	77,72	79,40	81,09	82,77	84,46	86,14	88,86	90,54
440	74,42	77,16	78,87	80,59	82,30	84,01	85,72	88,46	90,18	91,89
450	75,52	78,29	80,03	81,77	83,51	85,25	87,00	89,76	91,50	93,24
460	77,66	79,43	81,20	82,96	84,73	86,50	89,29	91,06	92,83	94,59
470	78,78	80,57	82,36	84,16	85,95	88,78	90,57	92,36	94,16	95,95
480	79,90	81,72	83,54	85,36	87,18	90,03	91,85	93,67	95,50	97,32
490	81,02	82,87	84,72	86,57	89,45	91,29	93,14	94,99	96,84	98,69
500	82,15	84,03	85,90	87,78	90,68	92,56	94,44	96,31	98,19	101,09



QR-Code einfach scannen und **Austrotherm Materiallisten-Generator** online nutzen.

Austrotherm GmbH, Am Kreuzweg 43, A-7423 Pinkafeld,
Tel.: +43 2633 401-347, Fax DW 370, fassadenprofile@austrotherm.at

Ab 100 lfm wenden Sie sich bitte an das Team Austrotherm Fassadenprofile für ein individuelles Angebot!
Status: Juni 2014. Fehler, Irrtümer und Änderungen vorbehalten.

Preisliste 51-100 lfm

Profilbreite in mm →

Profilhöhe
in mm



in €	310	320	330	340	350	360	370	380	390	400
10	33,06	33,62	34,19	34,76	35,33	35,90	36,47	37,03	37,60	38,17
20	33,06	33,62	34,19	34,76	35,33	35,90	36,47	37,03	37,60	38,17
30	34,22	34,81	35,41	36,00	36,60	37,19	37,79	38,39	38,98	39,58
40	35,38	36,00	36,63	37,25	37,87	38,50	40,15	40,77	41,39	42,02
50	36,55	38,23	38,88	39,53	40,18	40,83	41,48	42,13	42,78	43,43
60	38,76	39,44	40,11	40,79	41,47	42,14	42,82	43,50	44,18	44,85
70	39,94	40,64	41,35	42,05	42,76	43,46	44,17	44,87	45,57	46,28
80	41,13	41,86	42,59	43,32	44,05	44,78	45,52	46,25	46,98	47,71
90	42,32	43,08	43,83	44,59	45,35	46,11	46,87	47,63	48,39	49,15
100	43,51	44,30	45,08	45,87	46,66	47,44	48,23	49,02	49,80	50,59
110	44,71	45,53	46,34	47,15	47,97	48,78	49,59	51,44	52,25	53,06
120	45,92	46,76	47,60	48,44	50,31	51,15	51,99	52,84	53,68	54,52
130	47,13	48,00	49,90	50,77	51,63	52,50	53,37	54,24	55,11	55,97
140	49,38	50,27	51,17	52,06	52,96	53,85	54,75	55,65	56,54	57,44
150	50,60	51,52	52,45	53,37	54,29	55,21	56,14	57,06	57,98	61,13
160	51,83	52,78	53,73	54,68	55,63	56,58	59,75	60,70	61,65	62,60
170	53,06	54,04	55,01	55,99	59,20	60,17	61,15	62,13	63,10	64,08
180	54,30	55,30	58,53	59,54	60,54	61,55	62,55	63,55	65,59	66,59
190	57,77	58,80	59,83	60,86	61,89	62,92	64,99	66,02	67,05	68,08
200	59,02	60,08	61,13	62,19	64,28	65,34	66,40	67,46	68,51	69,57
210	60,27	61,36	63,47	64,56	65,64	66,73	67,81	68,90	69,99	71,07
220	61,53	63,67	64,78	65,90	67,01	68,12	69,24	70,35	71,46	72,57
230	63,82	64,96	66,10	67,24	68,38	69,52	70,66	71,80	72,94	74,08
240	65,09	66,26	67,42	68,59	69,76	70,93	72,09	73,26	74,43	76,63
250	66,36	67,56	68,75	69,95	71,14	72,34	73,53	74,73	76,95	78,15
260	67,64	68,86	70,09	71,31	72,53	73,75	76,00	77,23	78,45	79,67
270	68,93	70,17	71,42	72,67	73,92	76,20	77,45	78,70	79,95	81,20
280	70,21	71,49	72,77	74,04	76,35	77,63	78,90	80,18	81,46	82,73
290	71,51	72,81	74,12	76,45	77,75	79,06	80,36	81,66	82,97	84,27
300	72,81	74,14	76,50	77,83	79,16	80,49	81,82	83,15	84,48	85,82
310	74,11	76,50	77,86	79,22	80,58	81,93	83,29	83,15	86,01	88,40
320	76,45	77,84	79,22	80,61	81,99	83,38	84,76	86,15	88,57	89,95
330	77,77	79,18	80,59	82,00	83,42	84,83	86,24	88,69	90,10	91,51
340	79,09	80,53	81,97	83,41	84,85	86,29	88,76	90,20	91,64	93,08
350	80,41	81,88	83,35	84,81	86,28	88,78	90,24	91,71	93,18	94,65
360	81,74	83,24	84,73	86,23	88,75	90,24	91,74	93,23	94,73	96,22
370	83,08	84,60	86,12	88,67	90,19	91,72	93,24	94,76	96,28	97,80
380	84,42	85,97	88,55	90,09	91,64	93,19	94,74	96,29	97,84	100,42
390	85,76	88,37	89,95	91,52	93,10	94,67	96,25	97,83	100,43	102,01
400	88,15	89,75	91,35	92,95	94,56	96,16	97,76	100,40	102,00	103,60
410	89,50	91,13	92,76	94,39	96,02	97,65	100,31	101,94	103,57	105,21
420	90,86	92,52	94,18	95,84	97,49	100,18	101,84	103,50	105,15	106,81
430	92,23	93,91	95,60	97,28	100,00	101,68	103,37	105,05	106,74	108,42
440	93,60	95,31	97,02	98,74	101,48	103,19	104,90	106,62	108,33	110,04
450	94,98	96,72	98,46	101,23	102,96	104,70	106,44	108,18	109,92	112,69
460	96,36	98,12	100,92	102,69	104,46	106,22	107,99	109,75	112,55	124,34
470	97,75	100,57	102,36	104,16	105,95	107,74	109,54	112,36	124,17	125,97
480	99,14	101,99	103,81	105,63	107,45	109,27	112,12	123,96	125,78	127,60
490	101,57	103,41	105,26	107,11	108,96	110,81	113,68	125,55	127,40	129,25
500	102,97	104,84	106,72	108,59	110,47	113,38	125,27	127,14	129,02	130,89



QR-Code einfach scannen und **Austrotherm Materiallisten-Generator** online nutzen.

Austrotherm GmbH, Am Kreuzweg 43, A-7423 Pinkafeld,
Tel.: +43 2633 401-347, Fax DW 370, fassadenprofile@austrotherm.at

Ab 100 lfm wenden Sie sich bitte an das Team Austrotherm Fassadenprofile für ein individuelles Angebot!
Status: Juni 2014. Fehler, Irrtümer und Änderungen vorbehalten.

Preisliste 51-100 lfm

Profilbreite in mm →

Profilhöhe
in mm



in €	410	420	430	440	450	460	470	480	490	500
10	38,74	39,31	39,88	40,44	41,01	41,58	42,15	42,72	43,29	43,85
20	38,74	39,31	39,88	40,44	41,01	41,58	42,15	42,72	43,29	43,85
30	40,17	40,77	42,39	21,12	43,58	44,18	44,78	45,37	45,97	46,56
40	42,64	43,26	43,89	44,51	45,13	45,75	46,38	47,00	47,62	48,24
50	44,08	44,73	45,38	46,03	46,68	47,33	47,98	48,63	49,28	49,93
60	45,53	46,21	46,88	47,56	48,24	48,92	49,59	50,27	50,95	51,63
70	46,98	47,69	48,39	49,10	49,80	50,51	51,21	51,91	52,62	53,32
80	48,44	49,17	49,91	50,64	51,37	52,10	52,83	53,56	55,33	56,06
90	49,91	50,66	51,42	52,18	53,97	54,73	55,49	56,25	57,01	57,77
100	52,40	53,19	53,98	54,76	55,55	56,34	57,12	57,91	58,69	59,48
110	53,88	54,69	55,50	56,32	57,13	57,94	58,76	59,57	60,38	61,20
120	55,36	56,20	57,04	57,88	58,72	59,56	60,40	61,24	64,31	65,15
130	56,84	57,71	58,58	59,44	62,54	63,41	64,28	65,14	66,01	66,88
140	58,33	61,45	62,35	63,24	64,14	65,03	65,93	67,85	68,75	69,64
150	62,05	62,97	63,90	64,82	66,77	67,69	68,62	69,54	70,46	71,38
160	63,55	64,50	66,48	67,43	68,38	69,33	70,28	71,23	72,18	73,13
170	66,09	67,06	68,04	69,02	69,99	70,97	71,95	72,92	73,90	74,88
180	67,60	68,60	69,60	70,61	71,61	72,62	73,62	74,62	75,63	76,63
190	69,11	70,14	71,17	72,21	73,24	74,27	75,30	76,33	77,36	79,42
200	70,63	71,69	72,75	73,81	74,87	75,92	76,98	79,07	80,13	81,19
210	72,16	73,24	74,33	75,41	76,50	78,62	79,70	80,79	81,87	82,96
220	73,69	74,80	75,91	78,06	79,17	80,28	81,40	82,51	83,62	84,73
230	75,22	77,39	78,53	79,67	80,81	81,95	83,09	84,23	85,37	86,51
240	77,79	78,96	80,13	81,30	82,46	83,63	84,80	85,97	87,13	88,30
250	79,34	80,53	81,73	82,92	84,12	85,31	86,51	87,70	89,93	91,12
260	80,89	82,11	83,33	84,56	85,78	87,00	89,25	90,47	91,70	92,92
270	82,45	83,70	84,95	86,19	87,44	89,72	90,97	92,22	93,47	94,72
280	84,01	85,28	86,56	88,87	90,14	91,42	92,70	93,97	95,25	96,53
290	85,57	86,88	89,21	90,52	91,82	93,12	94,43	95,73	97,03	98,34
300	88,18	89,51	90,84	92,17	93,50	94,83	96,16	97,49	98,82	101,18
310	89,75	91,11	92,47	93,83	95,19	96,54	97,90	99,26	101,65	103,01
320	91,34	92,72	94,11	95,49	96,88	98,26	100,68	102,06	103,45	104,83
330	92,92	94,34	95,75	97,16	98,57	101,02	102,43	103,84	105,25	106,67
340	94,52	95,95	97,39	98,83	101,30	102,74	104,18	105,62	107,06	108,50
350	96,11	97,58	100,08	101,54	103,01	104,48	105,94	107,41	108,88	110,35
360	97,71	100,24	101,73	103,23	104,72	106,22	107,71	109,20	110,70	113,22
370	100,35	101,87	103,40	104,92	106,44	107,96	109,48	112,03	113,56	125,09
380	101,97	103,51	105,06	106,61	108,16	109,71	112,29	123,85	125,40	126,95
390	103,58	105,16	106,74	108,31	109,89	112,49	124,09	125,66	127,24	128,81
400	105,21	106,81	108,41	110,02	112,65	124,27	125,87	127,48	129,08	130,68
410	106,84	108,47	110,10	112,76	124,40	126,03	127,67	129,30	130,93	132,56
420	108,47	110,13	112,81	124,49	126,15	127,80	129,46	131,12	133,81	135,47
430	110,11	112,82	124,52	126,21	127,89	129,58	131,26	133,98	135,66	137,35
440	112,78	124,51	126,22	127,94	129,65	131,36	134,10	135,81	137,53	139,24
450	124,45	126,19	127,93	129,67	131,40	134,17	135,91	137,65	139,39	141,13
460	126,10	127,87	129,63	131,40	134,20	135,96	137,73	139,50	141,26	143,03
470	127,76	129,55	131,35	134,17	135,97	137,76	139,55	141,35	143,14	145,97
480	129,43	131,25	134,10	135,92	137,74	139,56	141,38	143,20	146,05	147,88
490	131,09	133,97	135,82	137,67	139,52	141,37	143,21	146,09	147,94	149,79
500	132,77	135,68	137,55	139,43	141,30	143,18	146,08	147,96	149,83	151,71



QR-Code einfach scannen und **Austrotherm Materiallisten-Generator** online nutzen.

Austrotherm GmbH, Am Kreuzweg 43, A-7423 Pinkafeld,
Tel.: +43 2633 401-347, Fax DW 370, fassadenprofile@austrotherm.at

Ab 100 lfm wenden Sie sich bitte an das Team Austrotherm Fassadenprofile für ein individuelles Angebot!
Status: Juni 2014. Fehler, Irrtümer und Änderungen vorbehalten.

Austrotherm Brettprofil

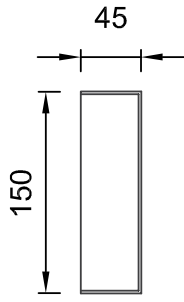

Art.Nr.:FBXAPK

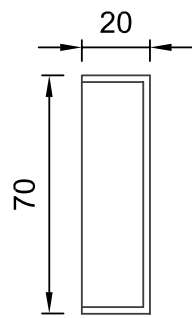

Art.Nr.:FBXAPS

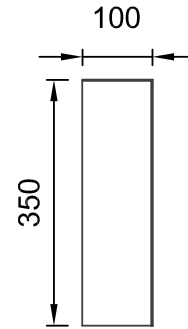

Art.Nr.:FBXARZ

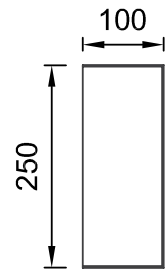

Art.Nr.:FBXASD

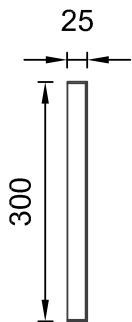

Art.Nr.:FBXAPL

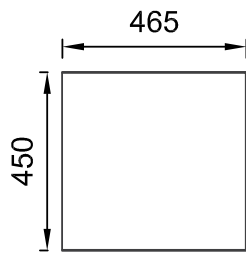

Art.Nr.:FBXART

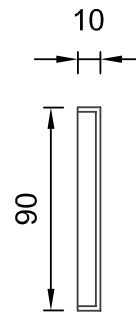

Art.Nr.:FBXASA

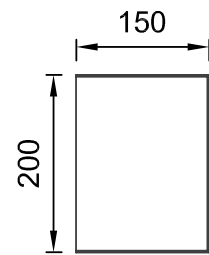

Art.Nr.:FBXASE

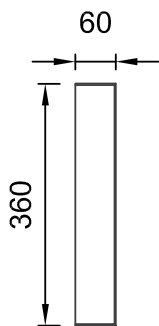

Art.Nr.:FBXAPN

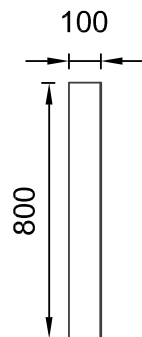

Art.Nr.:FBXARU

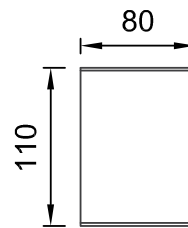

Art.Nr.:FBXASB

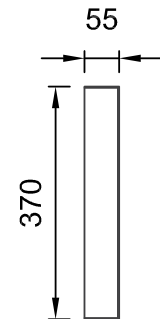

Art.Nr.:FBXASG

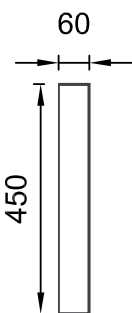

Art.Nr.:FBXAPO

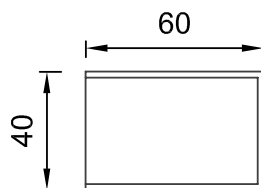

Art.Nr.:FBXARW

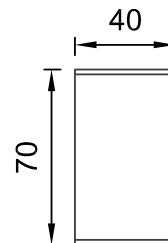

Art.Nr.:FBXASC

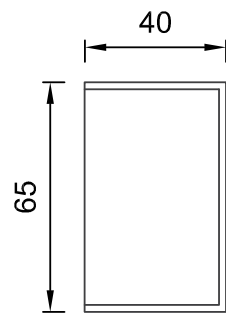

Art.Nr.:FBXASH



QR-Code einfach scannen und
Austrotherm Materiallisten-Generator
online nutzen.

Austrotherm Brettprofil

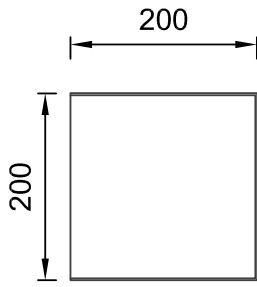

Art.Nr.:FBXASY

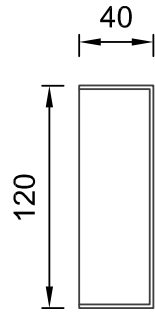

Art.Nr.:FBXATC

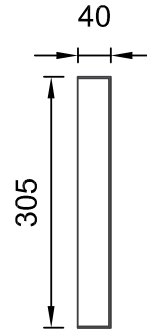

Art.Nr.:FBXATG

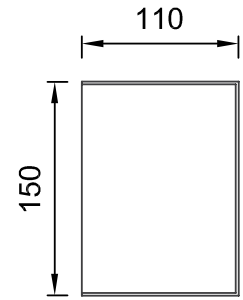

Art.Nr.:FBXATK

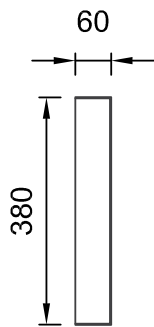

Art.Nr.:FBXASZ

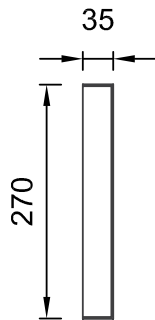

Art.Nr.:FBXATD

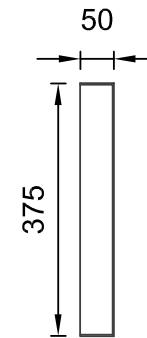

Art.Nr.:FBXATH

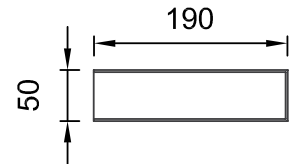

Art.Nr.:FBXATL

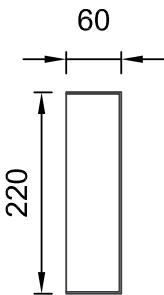

Art.Nr.:FBXATA

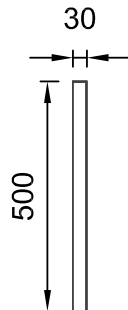

Art.Nr.:FBXATE

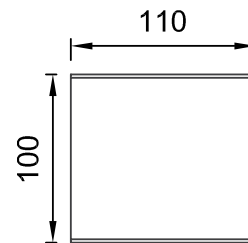

Art.Nr.:FBXATI

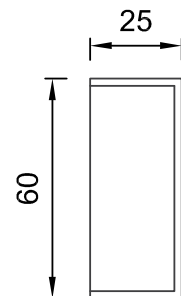

Art.Nr.:FBXATM

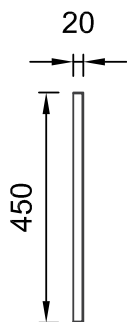

Art.Nr.:FBXATB

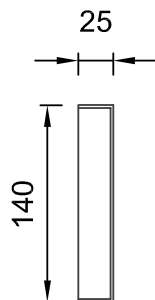

Art.Nr.:FBXATF

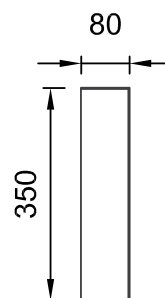

Art.Nr.:FBXATJ

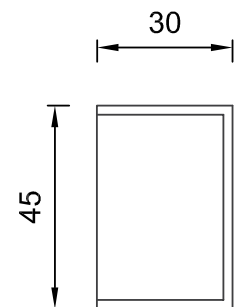

Art.Nr.:FBXATN



QR-Code einfach scannen und
Austrotherm Materiallisten-Generator
online nutzen.

Austrotherm Brettprofil

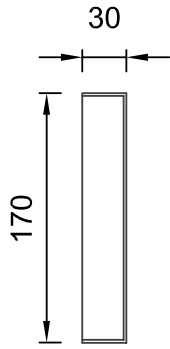

Art.Nr.:FBXABG

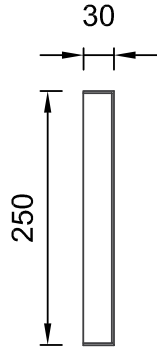

Art.Nr.:FBXABK

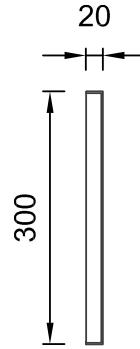

Art.Nr.:FBXABO

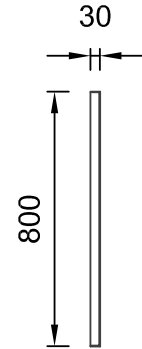

Art.Nr.:FBXABS

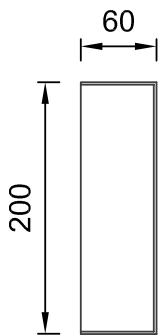

Art.Nr.:FBXABH

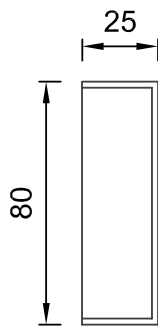

Art.Nr.:FBXABL

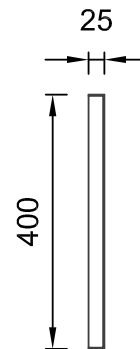

Art.Nr.:FBXABP

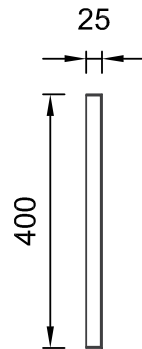

Art.Nr.:FBXABT

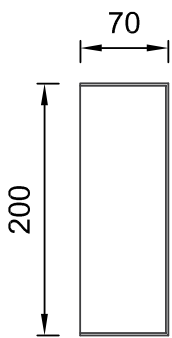

Art.Nr.:FBXABI

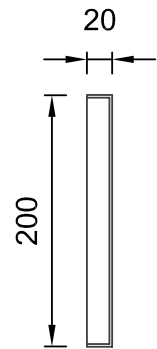

Art.Nr.:FBXABM

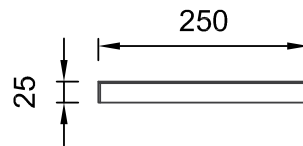

Art.Nr.:FBXABQ

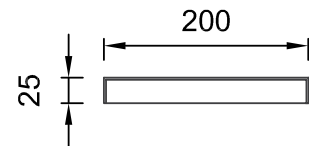

Art.Nr.:FBXABU

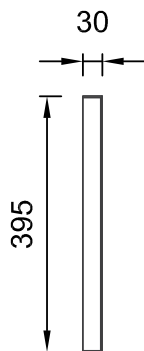

Art.Nr.:FBXABJ

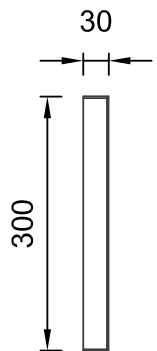

Art.Nr.:FBXABN

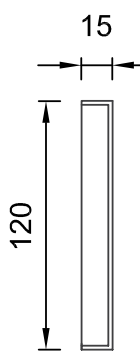

Art.Nr.:FBXABR

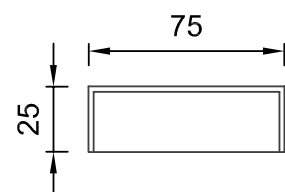

Art.Nr.:FBXABV



QR-Code einfach scannen und
Austrotherm Materiallisten-Generator
online nutzen.

Austrotherm Brettprofil

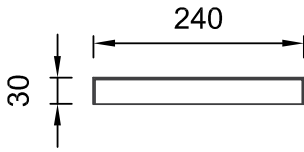

Art.Nr.:FBXABW

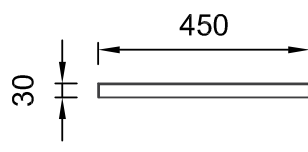

Art.Nr.:FBXACA

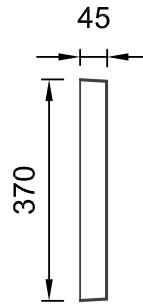

Art.Nr.:FBXACF

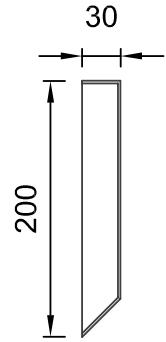

Art.Nr.:FBXACJ

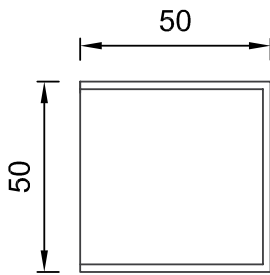

Art.Nr.:FBXABX

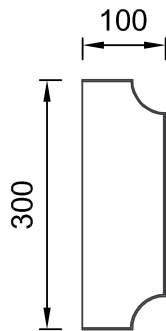

Art.Nr.:FBXACB

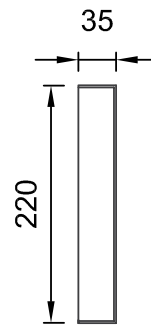

Art.Nr.:FBXACG

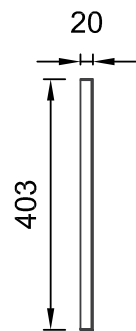

Art.Nr.:FBXACK

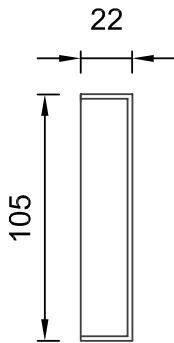

Art.Nr.:FBXABY

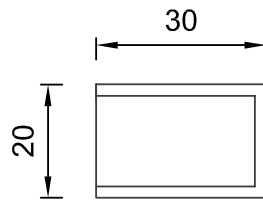

Art.Nr.:FBXACD

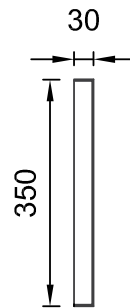

Art.Nr.:FBXACH

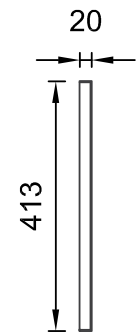

Art.Nr.:FBXACL

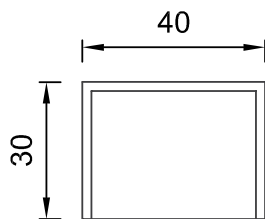

Art.Nr.:FBXABZ

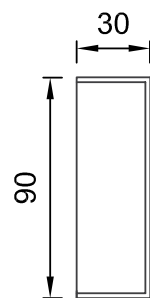

Art.Nr.:FBXACE

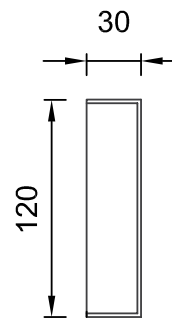

Art.Nr.:FBXACI

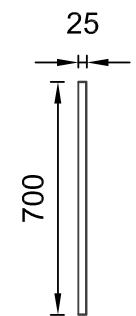

Art.Nr.:FBXACM



QR-Code einfach scannen und
Austrotherm Materialisten-Generator
online nutzen.

Austrotherm Brettprofil

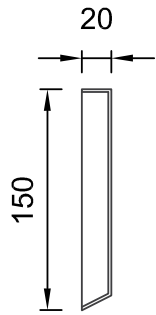

Art.Nr.:FBXACN

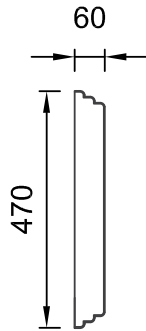

Art.Nr.:FBXACR

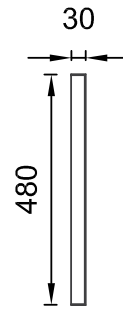

Art.Nr.:FBXACV

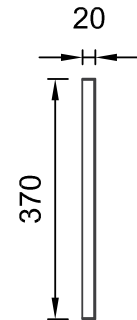

Art.Nr.:FBXACZ

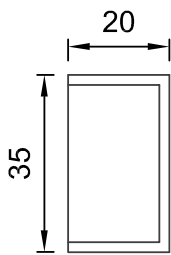

Art.Nr.:FBXACO

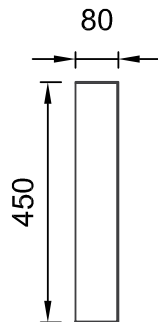

Art.Nr.:FBXACS

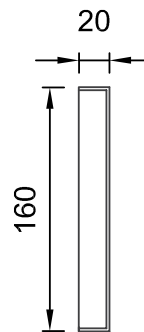

Art.Nr.:FBXACW

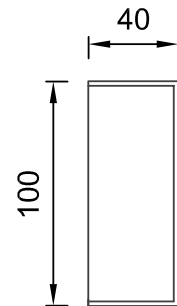

Art.Nr.:FBXADB

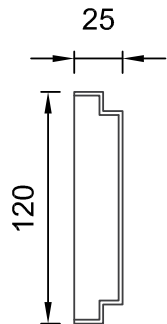

Art.Nr.:FBXACP

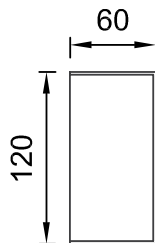

Art.Nr.:FBXACT

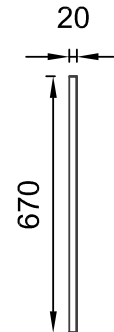

Art.Nr.:FBXACX

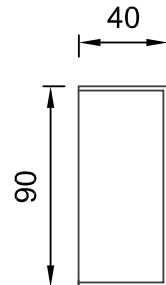

Art.Nr.:FBXADC

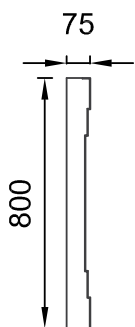

Art.Nr.:FBXACQ

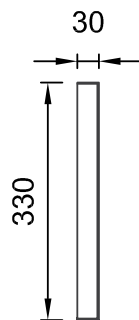

Art.Nr.:FBXACU

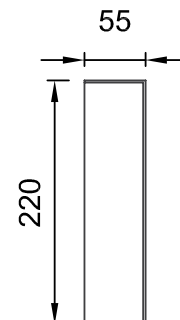

Art.Nr.:FBXACY

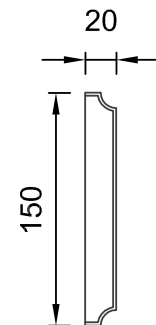

Art.Nr.:FBXADD



QR-Code einfach scannen und
Austrotherm Materiallist-Generator
online nutzen.

Austrotherm Brettprofil

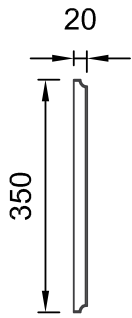

Art.Nr.:FBXADE

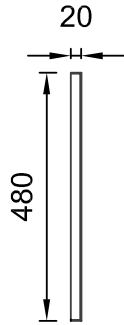

Art.Nr.:FBXADI

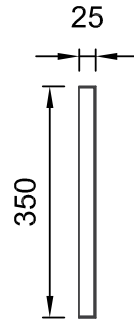

Art.Nr.:FBXADM

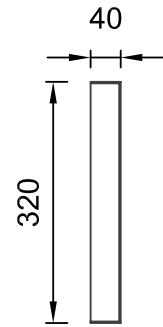

Art.Nr.:FBXADQ

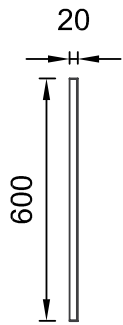

Art.Nr.:FBXADF

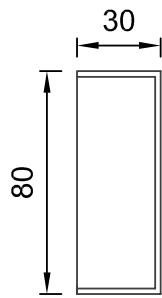

Art.Nr.:FBXADJ

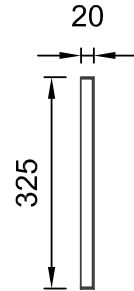

Art.Nr.:FBXADN

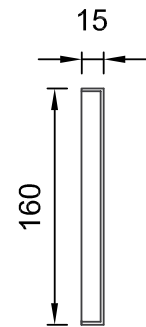

Art.Nr.:FBXADR

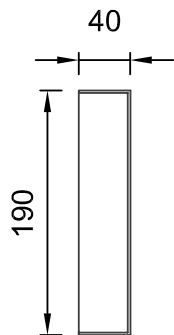

Art.Nr.:FBXADG

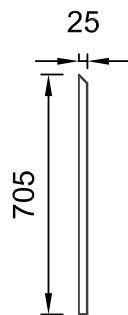

Art.Nr.:FBXADK

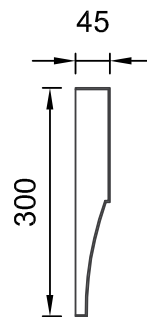

Art.Nr.:FBXADO

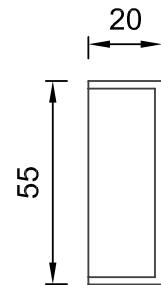

Art.Nr.:FBXADT

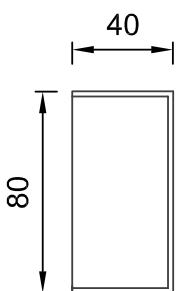

Art.Nr.:FBXADH

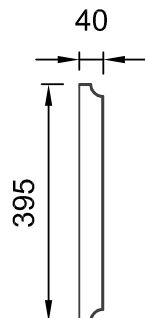

Art.Nr.:FBXADL

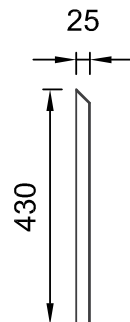

Art.Nr.:FBXADP

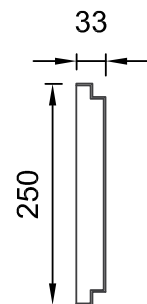

Art.Nr.:FBXADX



QR-Code einfach scannen und
Austrotherm Materiallist-Generator
online nutzen.

Austrotherm Brettprofil

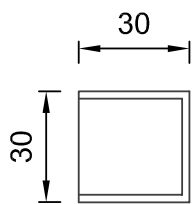

Art.Nr.:FBXADZ

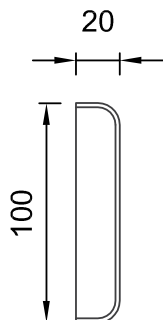

Art.Nr.:FBXAEG

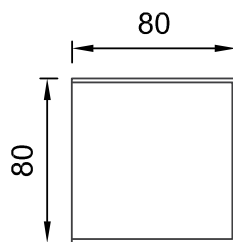

Art.Nr.:FBXAEL

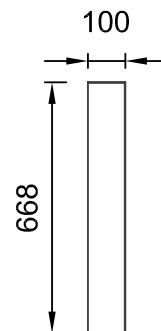

Art.Nr.:FBXAEP

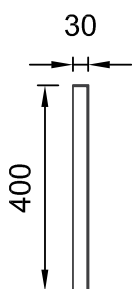

Art.Nr.:FBXAEA

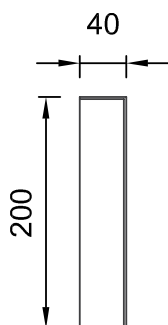

Art.Nr.:FBXAEH

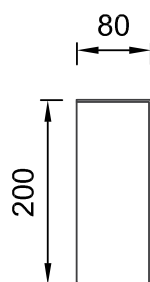

Art.Nr.:FBXAEM

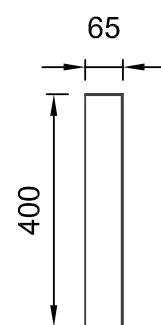

Art.Nr.:FBXAEQ

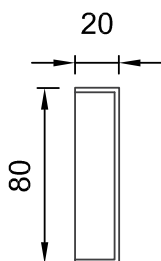

Art.Nr.:FBXAEC

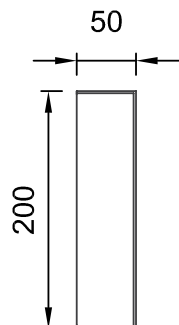

Art.Nr.:FBXA EI

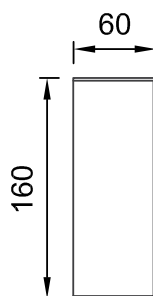

Art.Nr.:FBXAEN

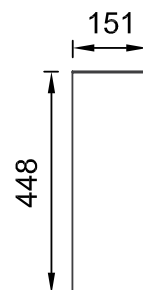

Art.Nr.:FBXAER

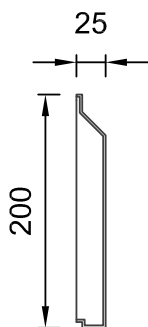

Art.Nr.:FBXAED

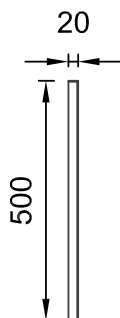

Art.Nr.:FBXA EJ

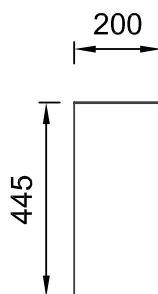

Art.Nr.:FBXAEO

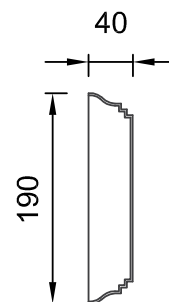

Art.Nr.:FBXA EW



QR-Code einfach scannen und
Austrotherm Materiallisten-Generator
online nutzen.

Austrotherm Brettprofil

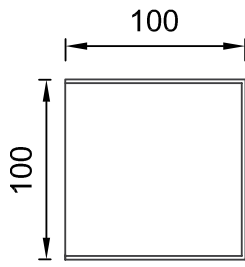

Art.Nr.:FBXAEX

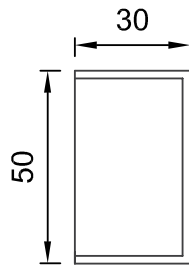

Art.Nr.:FBXAFG

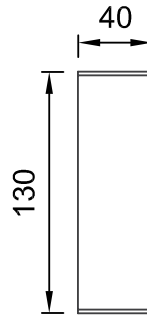

Art.Nr.:FBXAFL

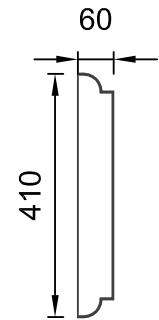

Art.Nr.:FBXAFT

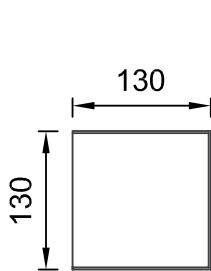

Art.Nr.:FBXAEY

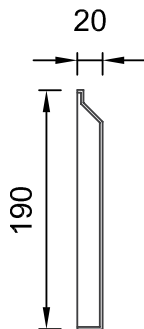

Art.Nr.:FBXAFI

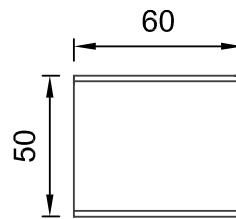

Art.Nr.:FBXAFM

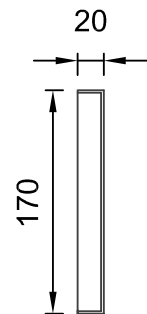

Art.Nr.:FBXAFU

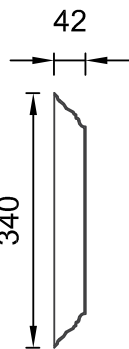

Art.Nr.:FBXAFC

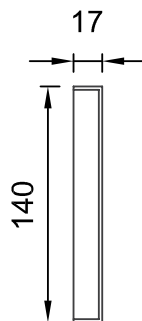

Art.Nr.:FBXAFJ

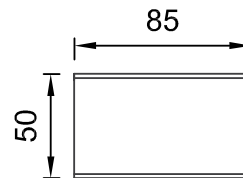

Art.Nr.:FBXAFN

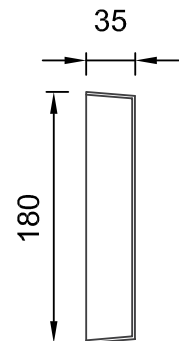

Art.Nr.:FBXAFW

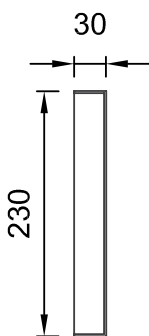

Art.Nr.:FBXAFF

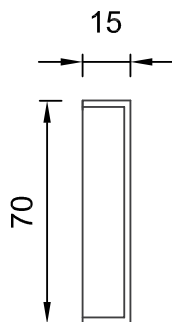

Art.Nr.:FBXAFK

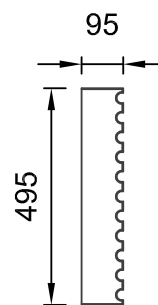

Art.Nr.:FBXAFS

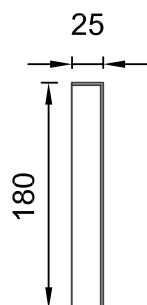

Art.Nr.:FBXAFZ



QR-Code einfach scannen und
Austrotherm Materialisten-Generator
online nutzen.

Austrotherm Brettprofil

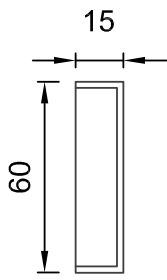

Art.Nr.:FBXAGA

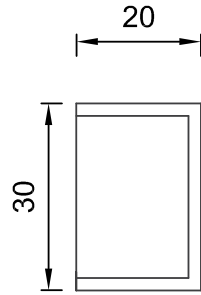

Art.Nr.:FBXAGG

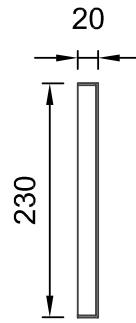

Art.Nr.:FBXAGM

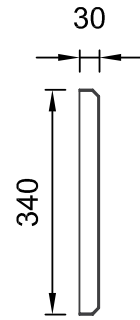

Art.Nr.:FBXAGQ

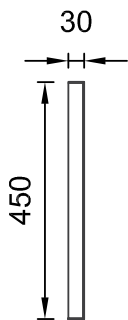

Art.Nr.:FBXAGB

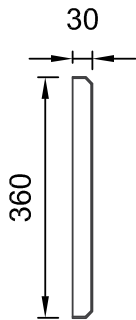

Art.Nr.:FBXAGH

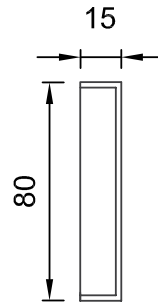

Art.Nr.:FBXAGN

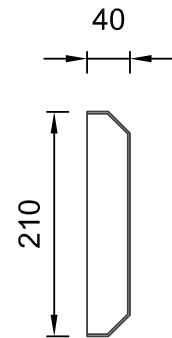

Art.Nr.:FBXAGR

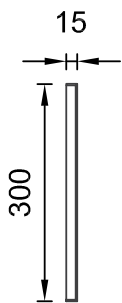

Art.Nr.:FBXAGC

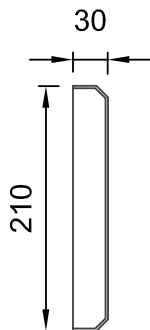

Art.Nr.:FBXAGI

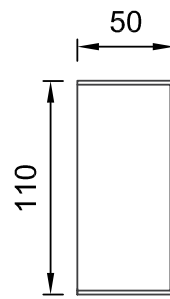

Art.Nr.:FBXAGO

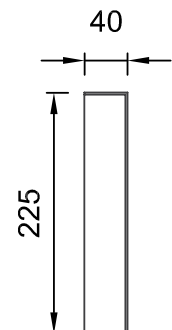

Art.Nr.:FBXAGS

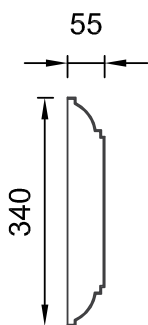

Art.Nr.:FBXAGE

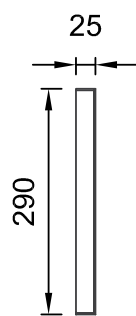

Art.Nr.:FBXAGL

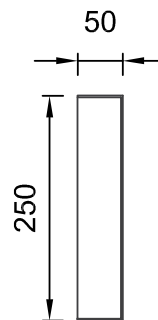

Art.Nr.:FBXAGP

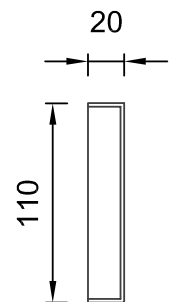

Art.Nr.:FBXAGY



QR-Code einfach scannen und
Austrotherm Materiallisten-Generator
online nutzen.

Austrotherm Brettprofil



Art.Nr.:FBXAHA



Art.Nr.:FBXAHK

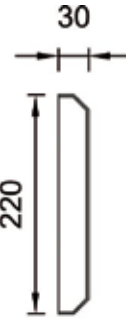

Art.Nr.:FBXAHY

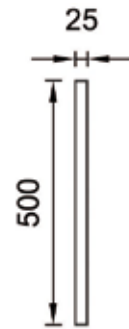

Art.Nr.:FBXAIC

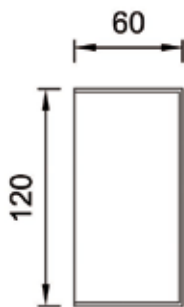

Art.Nr.:FBXAHB

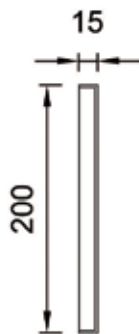

Art.Nr.:FBXAHO

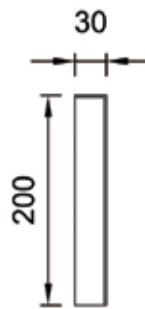

Art.Nr.:FBXAHZ

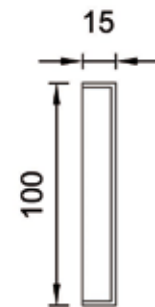

Art.Nr.:FBXAIE

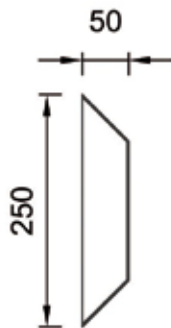

Art.Nr.:FBXAHD



Art.Nr.:FBXAHT

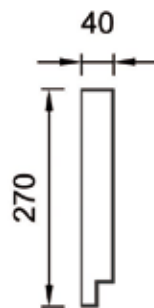

Art.Nr.:FBXAIA

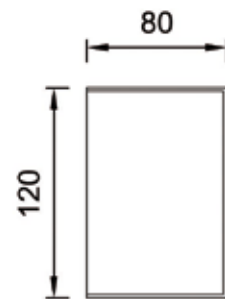

Art.Nr.:FBXAII

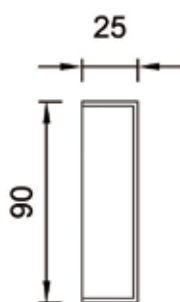

Art.Nr.:FBXAHF

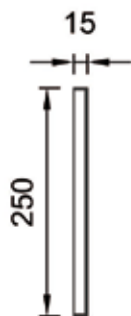

Art.Nr.:FBXAHU

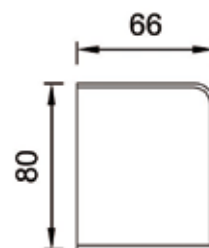

Art.Nr.:FBXAIB

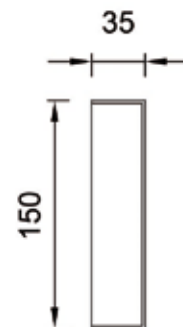

Art.Nr.:FBXAIL



QR-Code einfach scannen und
Austrotherm Materialisten-Generator
online nutzen.

Austrotherm Brettprofil

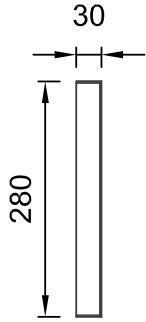

Art.Nr.:FBXAIM

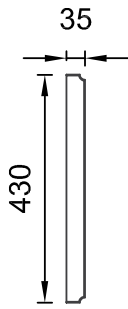

Art.Nr.:FBXAIT

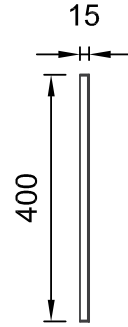

Art.Nr.:FBXAIY

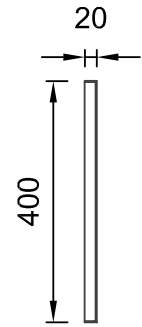

Art.Nr.:FBXAJC

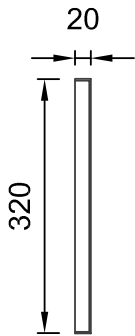

Art.Nr.:FBXAIP

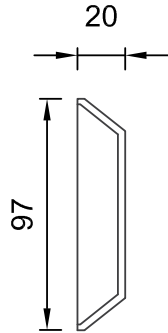

Art.Nr.:FBXAIU

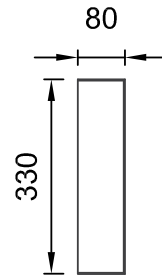

Art.Nr.:FBXAIZ

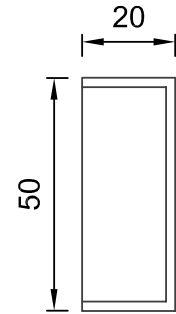

Art.Nr.:FBXAJD

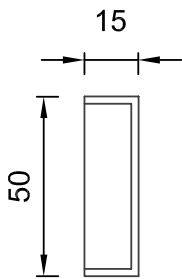

Art.Nr.:FBXAIR

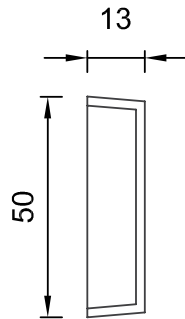

Art.Nr.:FBXAIV

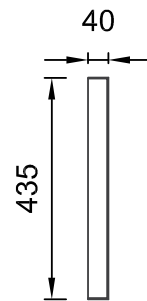

Art.Nr.:FBXAJA

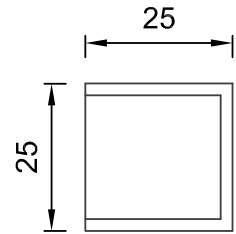

Art.Nr.:FBXAJE

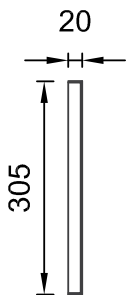

Art.Nr.:FBXAIS

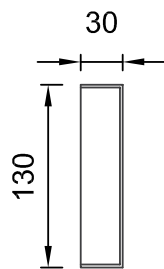

Art.Nr.:FBXAIX

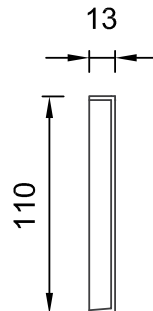

Art.Nr.:FBXAJB

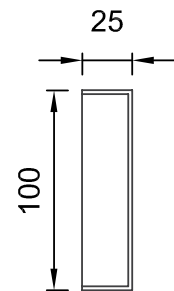

Art.Nr.:FBXAJF



QR-Code einfach scannen und
Austrotherm Materiallisten-Generator
online nutzen.

Austrotherm Brettprofil

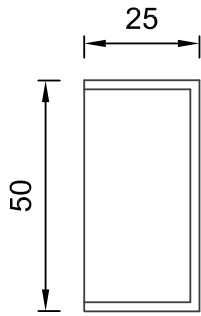

Art.Nr.:FBXAJG

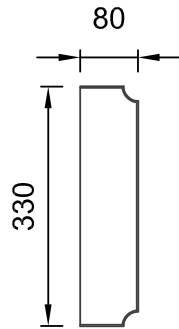

Art.Nr.:FBXAJL

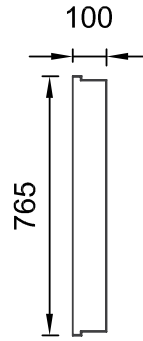

Art.Nr.:FBXAJR

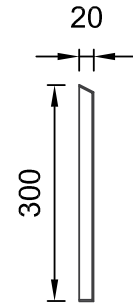

Art.Nr.:FBXAJX

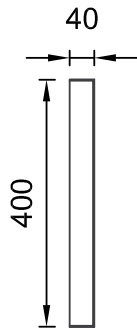

Art.Nr.:FBXAJH

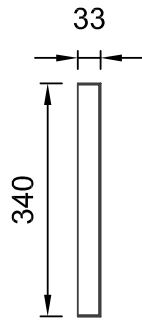

Art.Nr.:FBXAJM

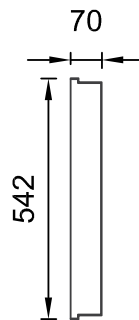

Art.Nr.:FBXAJS

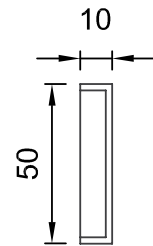

Art.Nr.:FBXAJY

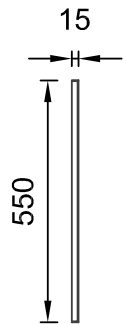

Art.Nr.:FBXAJJ

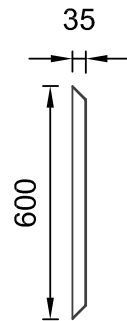

Art.Nr.:FBXAJP

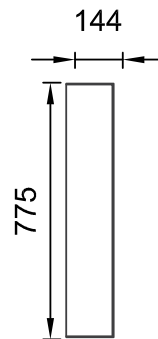

Art.Nr.:FBXAJT

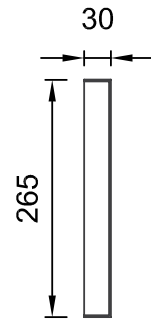

Art.Nr.:FBXAJZ

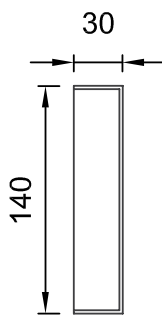

Art.Nr.:FBXAJK

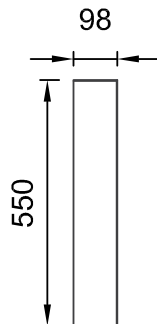

Art.Nr.:FBXAJQ

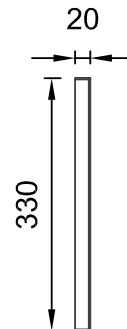

Art.Nr.:FBXAJV

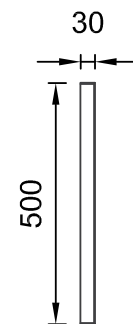

Art.Nr.:FBXAKA



QR-Code einfach scannen und
Austrotherm Materialisten-Generator
online nutzen.

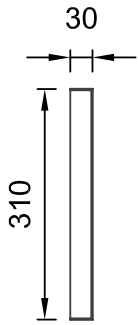

Art.Nr.:FBXAKB

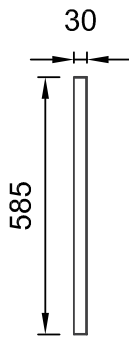

Art.Nr.:FBXAKF

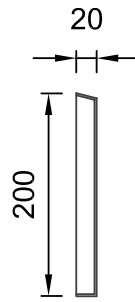

Art.Nr.:FBXAKJ

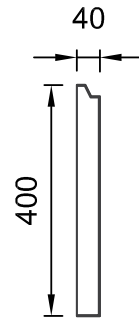

Art.Nr.:FBXAKR

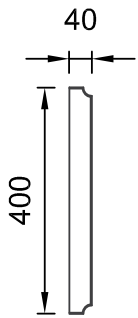

Art.Nr.:FBXAKC

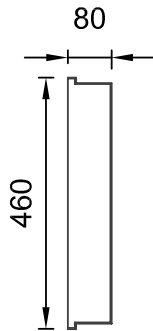

Art.Nr.:FBXAKG

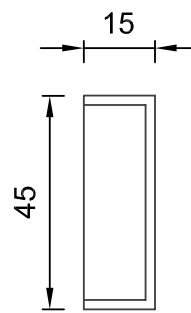

Art.Nr.:FBXAKK

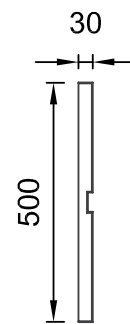

Art.Nr.:FBXAKS

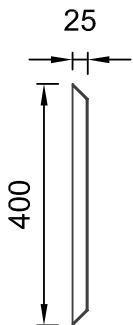

Art.Nr.:FBXAKD

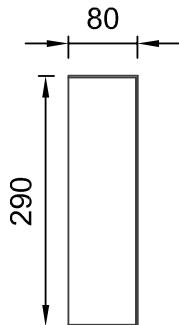

Art.Nr.:FBXAKH

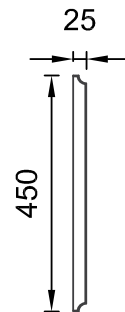

Art.Nr.:FBXAKM

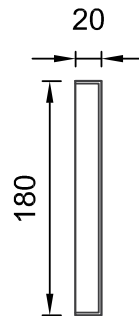

Art.Nr.:FBXAKT

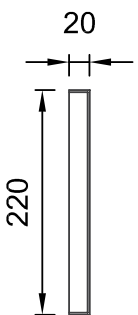

Art.Nr.:FBXAKE

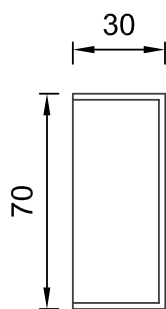

Art.Nr.:FBXAKI

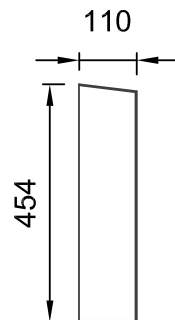

Art.Nr.:FBXAKP

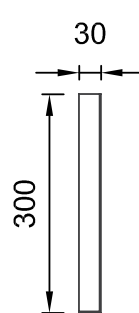

Art.Nr.:FBXAKV



QR-Code einfach scannen und
Austrotherm Materiallist-Generator
online nutzen.

Austrotherm Brettprofil

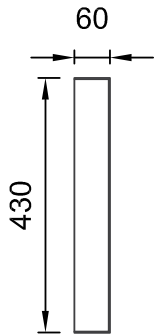

Art.Nr.:FBXAKW

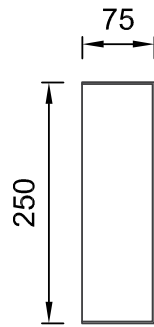

Art.Nr.:FBXALA

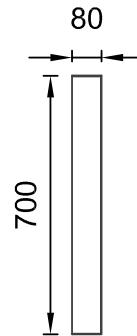

Art.Nr.:FBXALF

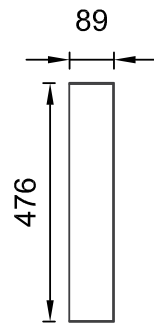

Art.Nr.:FBXALN

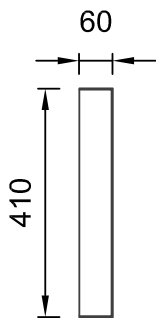

Art.Nr.:FBXAKX

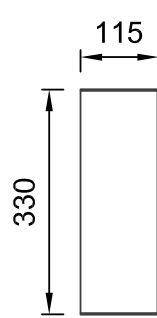

Art.Nr.:FBXALB

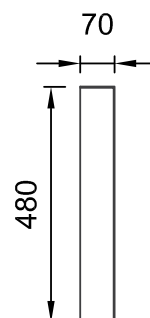

Art.Nr.:FBXALG

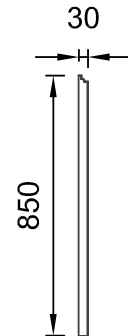

Art.Nr.:FBXALO

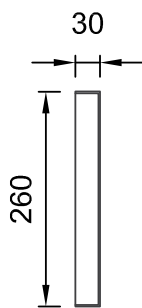

Art.Nr.:FBXAKY

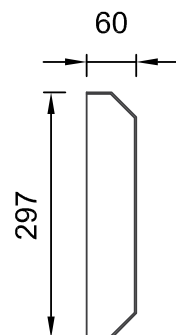

Art.Nr.:FBXALC

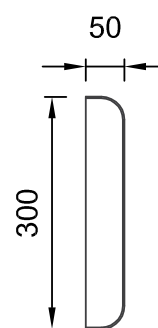

Art.Nr.:FBXALH

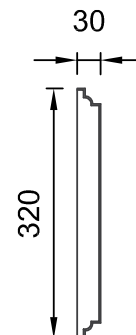

Art.Nr.:FBXALP

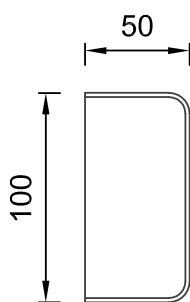

Art.Nr.:FBXAKZ

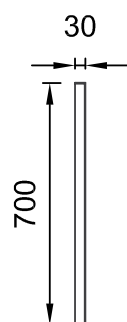

Art.Nr.:FBXALE

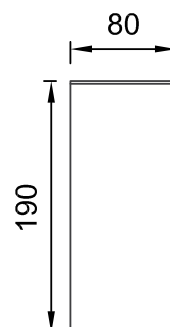

Art.Nr.:FBXALJ

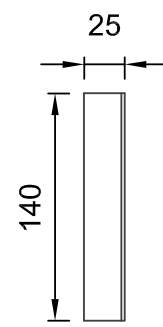

Art.Nr.:FBXALQ



QR-Code einfach scannen und
Austrotherm Materiallisten-Generator
online nutzen.

Austrotherm Brettprofil

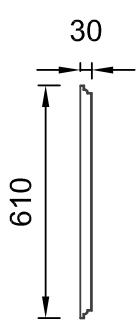

Art.Nr.:FBXALR

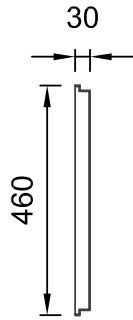

Art.Nr.:FBXALX

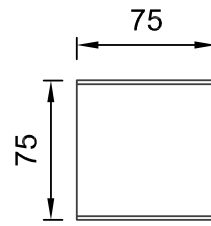

Art.Nr.:FBXAME

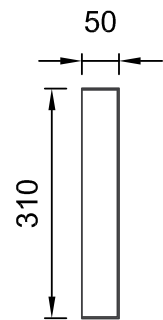

Art.Nr.:FBXAMK

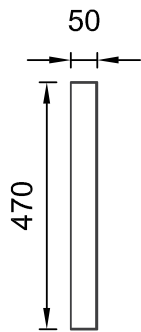

Art.Nr.:FBXALS

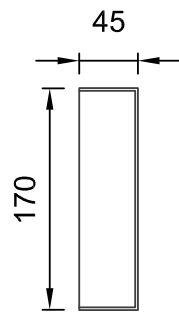

Art.Nr.:FBXALZ

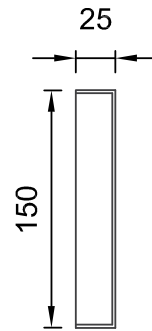

Art.Nr.:FBXAMG

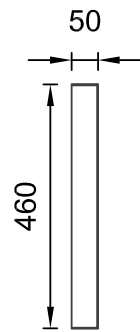

Art.Nr.:FBXAML

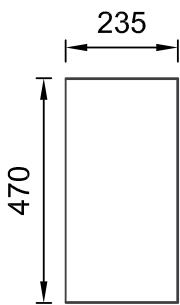

Art.Nr.:FBXALT

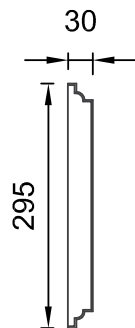

Art.Nr.:FBXAMA

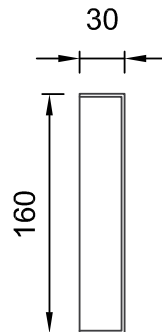

Art.Nr.:FBXAMH

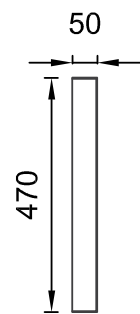

Art.Nr.:FBXAMM

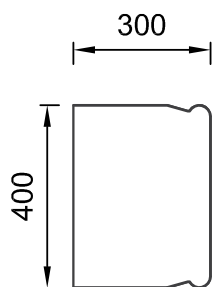

Art.Nr.:FBXALW

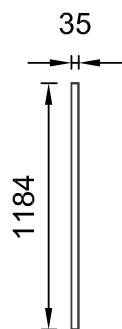

Art.Nr.:FBXAMD

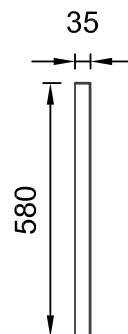

Art.Nr.:FBXAMJ

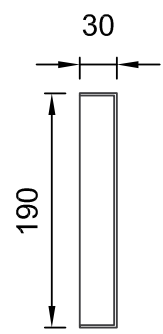

Art.Nr.:FBXAMN



QR-Code einfach scannen und
Austrotherm Materiallisten-Generator
online nutzen.

Austrotherm Brettprofil

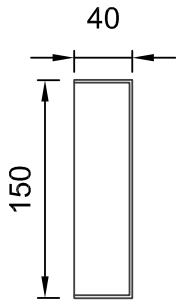

Art.Nr.:FBXAMO

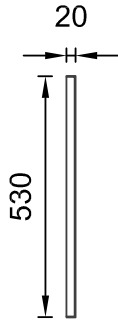

Art.Nr.:FBXAMT

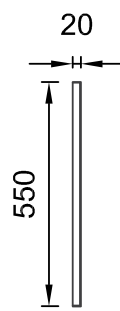

Art.Nr.:FBXAMY

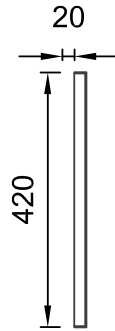

Art.Nr.:FBXANC

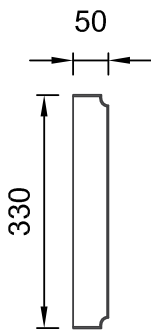

Art.Nr.:FBXAMP

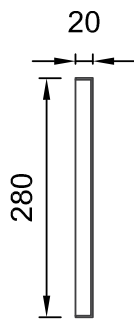

Art.Nr.:FBXAMU

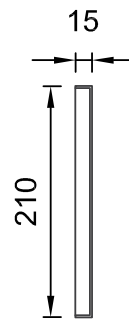

Art.Nr.:FBXAMZ

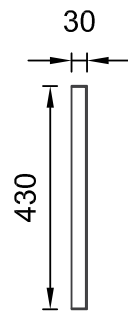

Art.Nr.:FBXANF

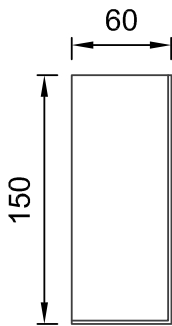

Art.Nr.:FBXAMR

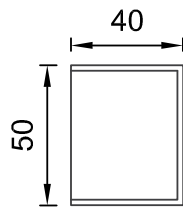

Art.Nr.:FBXAMV

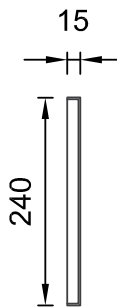

Art.Nr.:FBXANA

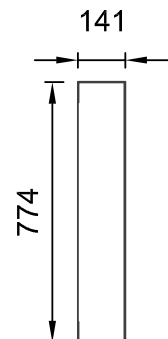

Art.Nr.:FBXANH

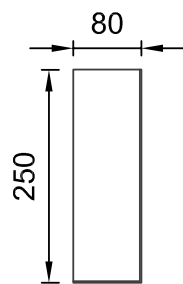

Art.Nr.:FBXAMS

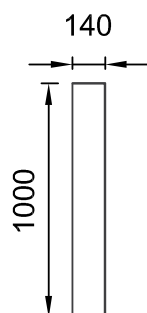

Art.Nr.:FBXAMW

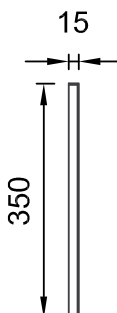

Art.Nr.:FBXANB

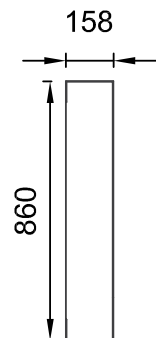

Art.Nr.:FBXANI



QR-Code einfach scannen und
Austrotherm Materiallisten-Generator
online nutzen.

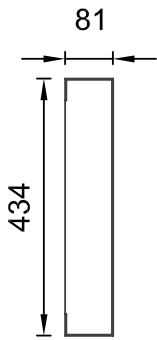

Art.Nr.:FBXANJ

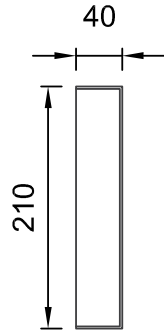

Art.Nr.:FBXANN

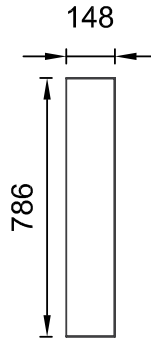

Art.Nr.:FBXANS

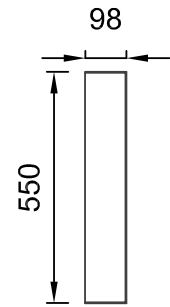

Art.Nr.:FBXANW

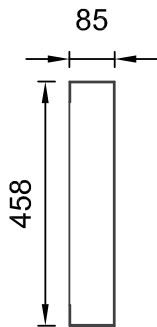

Art.Nr.:FBXANK

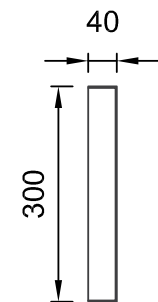

Art.Nr.:FBXANO

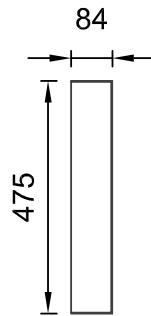

Art.Nr.:FBXANT

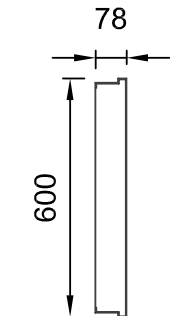

Art.Nr.:FBXANX

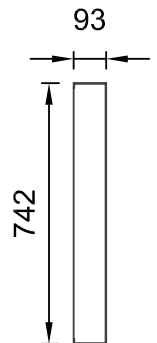

Art.Nr.:FBXANL

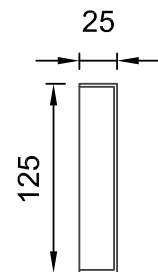

Art.Nr.:FBXANQ

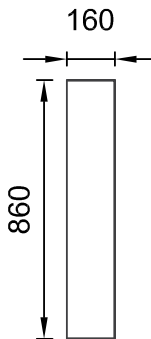

Art.Nr.:FBXANU

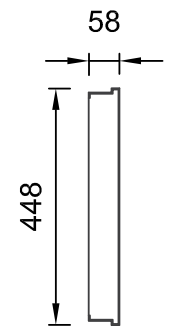

Art.Nr.:FBXANY

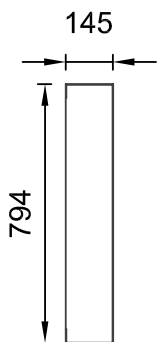

Art.Nr.:FBXANM

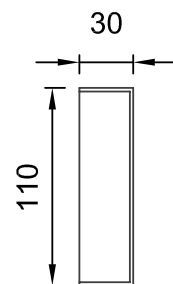

Art.Nr.:FBXANR

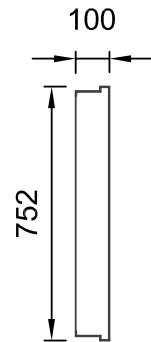

Art.Nr.:FBXANV

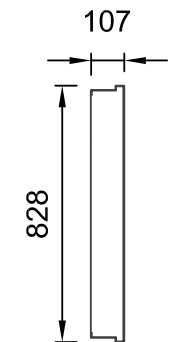

Art.Nr.:FBXANZ



QR-Code einfach scannen und
Austrotherm Materiallisten-Generator
online nutzen.

Austrotherm Brettprofil

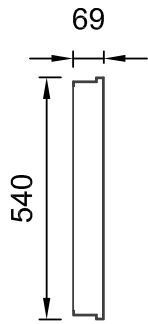

Art.Nr.:FBXAOA

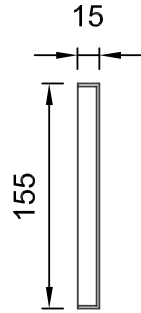

Art.Nr.:FBXAOF

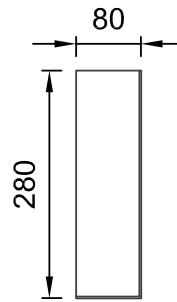

Art.Nr.:FBXAOK

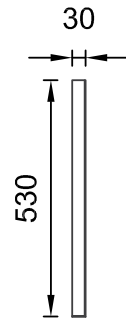

Art.Nr.:FBXAOO

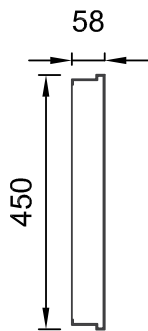

Art.Nr.:FBXAOB

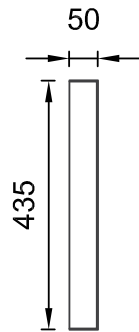

Art.Nr.:FBXAOG

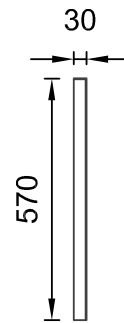

Art.Nr.:FBXAOL

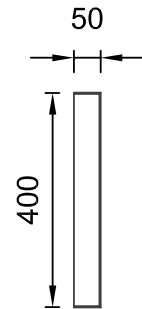

Art.Nr.:FBXAOP

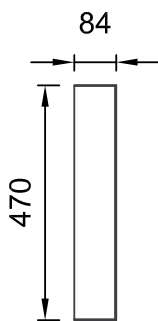

Art.Nr.:FBXAOD

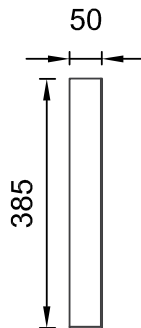

Art.Nr.:FBXAOH

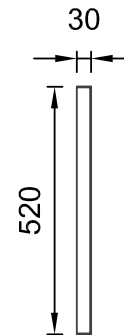

Art.Nr.:FBXAOM

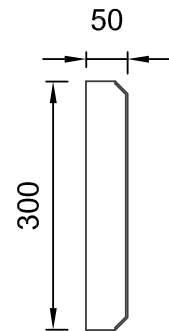

Art.Nr.:FBXAOR

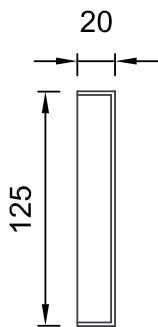

Art.Nr.:FBXAOE

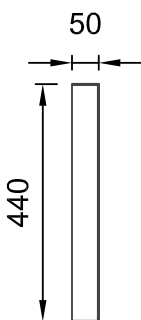

Art.Nr.:FBXAOJ

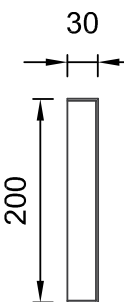

Art.Nr.:FBXAON

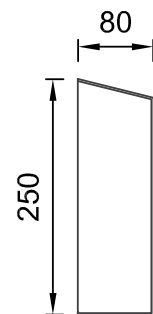

Art.Nr.:FBXAOS



QR-Code einfach scannen und
Austrotherm Materialisten-Generator
online nutzen.

Austrotherm Brettprofil

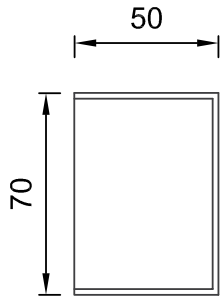

Art.Nr.:FBXAOT

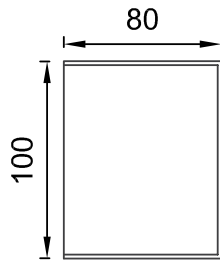

Art.Nr.:FBXAOX

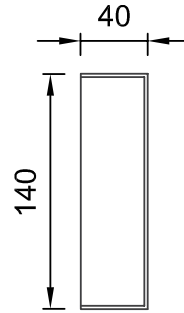

Art.Nr.:FBXAPB

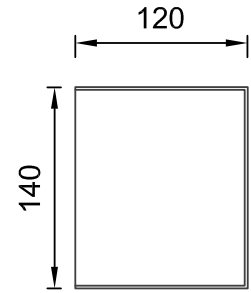

Art.Nr.:FBXAPF

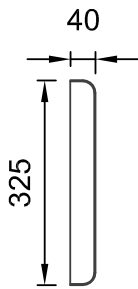

Art.Nr.:FBXAOU

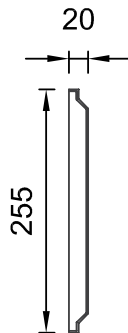

Art.Nr.:FBXAOY

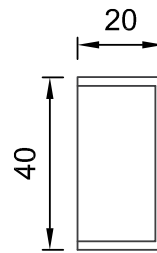

Art.Nr.:FBXAPC

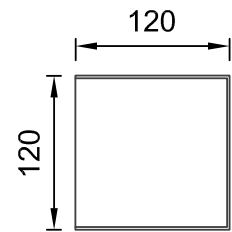

Art.Nr.:FBXAPG

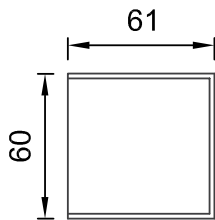

Art.Nr.:FBXAOV

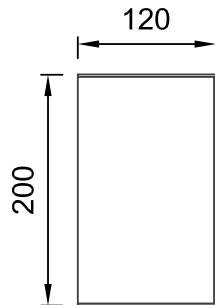

Art.Nr.:FBXAOZ

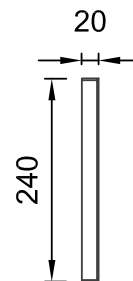

Art.Nr.:FBXAPD

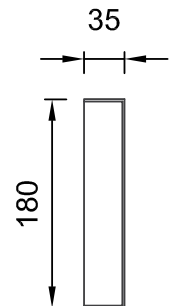

Art.Nr.:FBXAPH

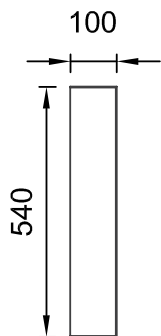

Art.Nr.:FBXAOW

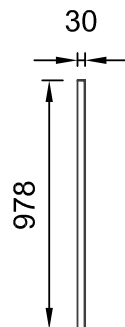

Art.Nr.:FBXAPA

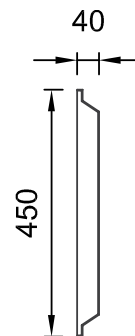

Art.Nr.:FBXAPE

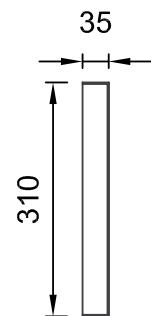

Art.Nr.:FBXAPJ



QR-Code einfach scannen und
Austrotherm Materiallisten-Generator
online nutzen.

Austrotherm Brettprofil

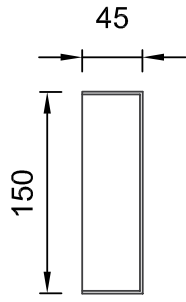

Art.Nr.:FBXAPK

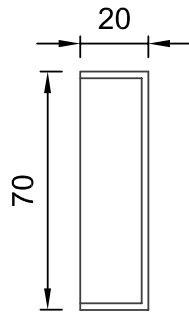

Art.Nr.:FBXAPS

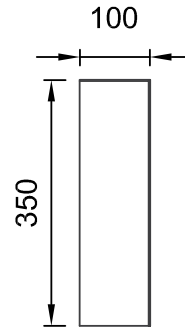

Art.Nr.:FBXARZ

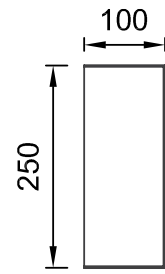

Art.Nr.:FBXASD

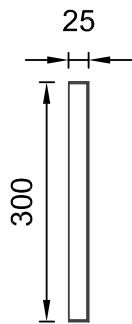

Art.Nr.:FBXAPL

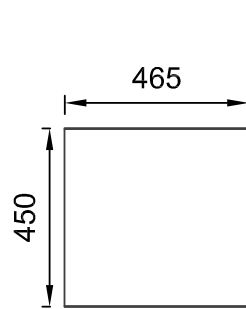

Art.Nr.:FBXART

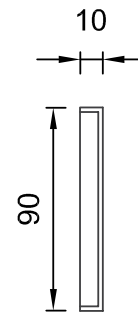

Art.Nr.:FBXASA

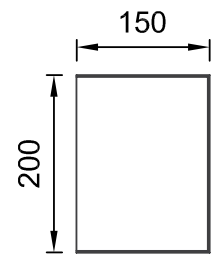

Art.Nr.:FBXASE

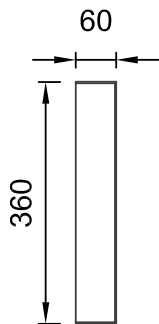

Art.Nr.:FBXAPN

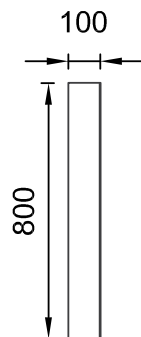

Art.Nr.:FBXARU

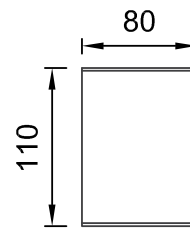

Art.Nr.:FBXASB

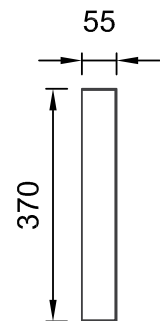

Art.Nr.:FBXASG

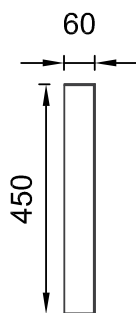

Art.Nr.:FBXAPO

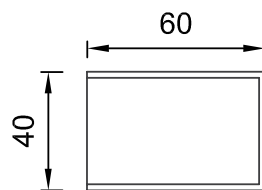

Art.Nr.:FBXARW

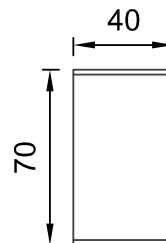

Art.Nr.:FBXASC

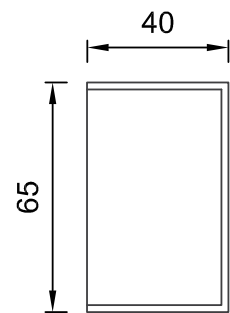

Art.Nr.:FBXASH



QR-Code einfach scannen und
Austrotherm Materiallisten-Generator
online nutzen.

Austrotherm Brettprofil

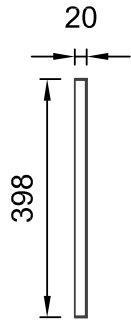

Art.Nr.:FBXASI

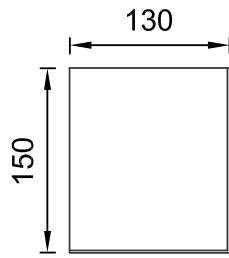

Art.Nr.:FBXASM

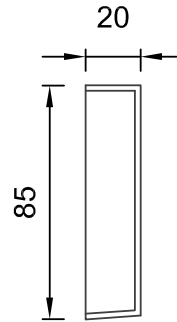

Art.Nr.:FBXASQ

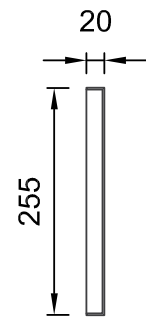

Art.Nr.:FBXASU

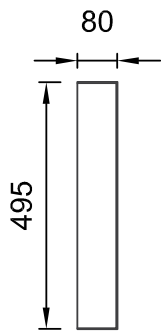

Art.Nr.:FBXASJ

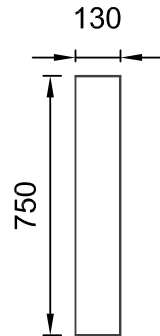

Art.Nr.:FBXASN

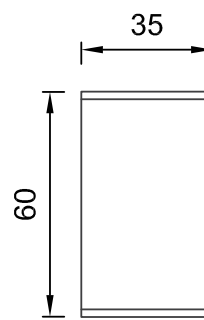

Art.Nr.:FBXASR

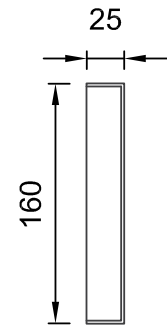

Art.Nr.:FBXASV

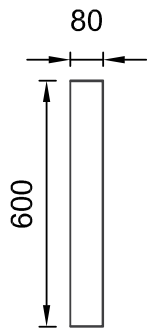

Art.Nr.:FBXASK

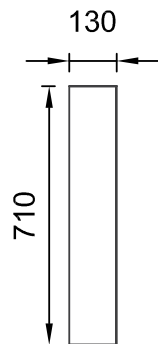

Art.Nr.:FBXASO

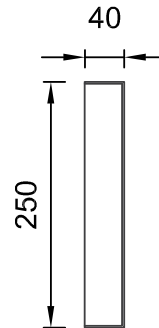

Art.Nr.:FBXASS

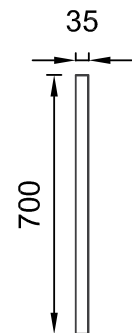

Art.Nr.:FBXASW

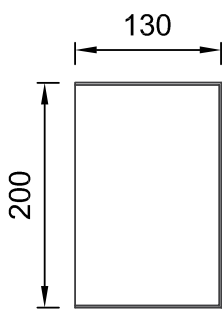

Art.Nr.:FBXASL

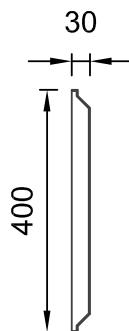

Art.Nr.:FBXASP

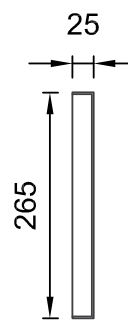

Art.Nr.:FBXAST

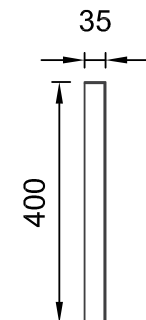

Art.Nr.:FBXASX



QR-Code einfach scannen und
Austrotherm Materiallisten-Generator
online nutzen.

Austrotherm Brettprofil

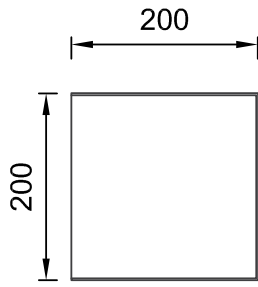

Art.Nr.:FBXASY

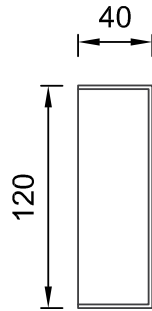

Art.Nr.:FBXATC

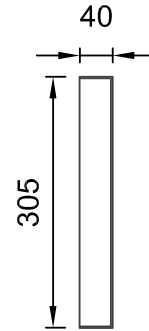

Art.Nr.:FBXATG

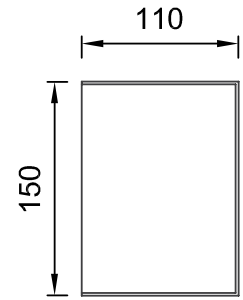

Art.Nr.:FBXATK

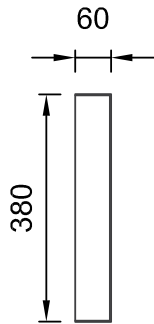

Art.Nr.:FBXASZ

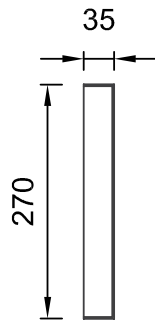

Art.Nr.:FBXATD

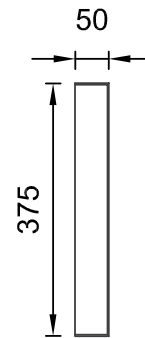

Art.Nr.:FBXATH

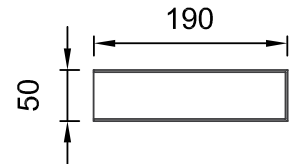

Art.Nr.:FBXATL

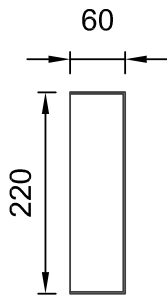

Art.Nr.:FBXATA

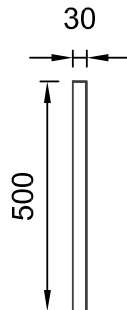

Art.Nr.:FBXATE

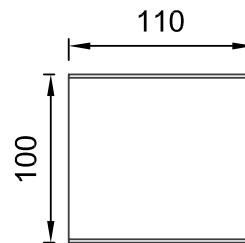

Art.Nr.:FBXATI

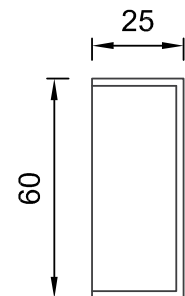

Art.Nr.:FBXATM

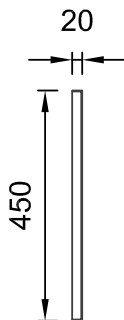

Art.Nr.:FBXATB

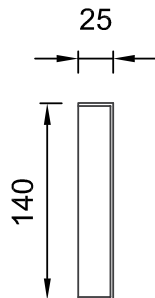

Art.Nr.:FBXATF

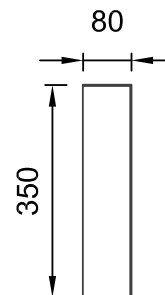

Art.Nr.:FBXATJ

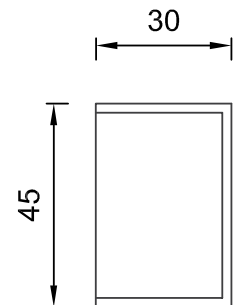

Art.Nr.:FBXATN



QR-Code einfach scannen und
Austrotherm Materiallisten-Generator
online nutzen.

Austrotherm Brettprofil

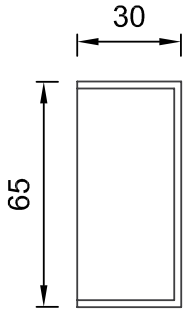

Art.Nr.:FBXATO

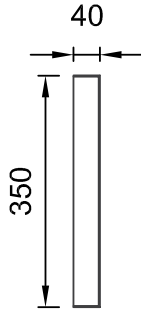

Art.Nr.:FBXATS

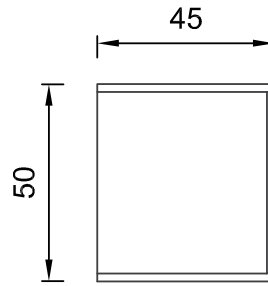

Art.Nr.:FBXATW

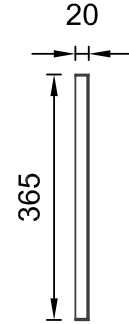

Art.Nr.:FBXAUA

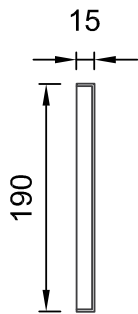

Art.Nr.:FBXATP

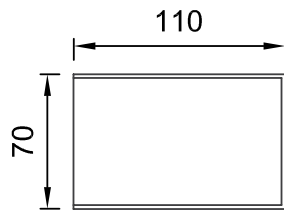

Art.Nr.:FBXATT

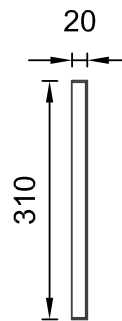

Art.Nr.:FBXATX

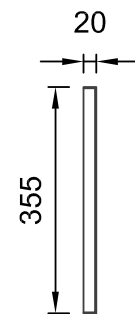

Art.Nr.:FBXAUB

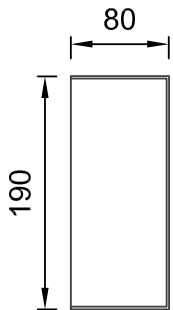

Art.Nr.:FBXATQ

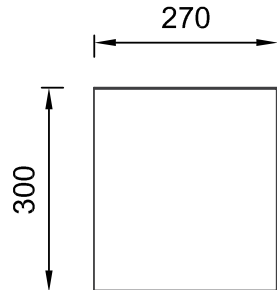

Art.Nr.:FBXATU

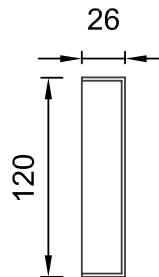

Art.Nr.:FBXATY

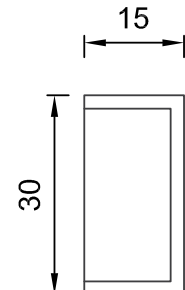

Art.Nr.:FBXAUC

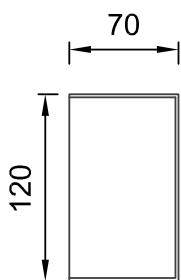

Art.Nr.:FBXATR

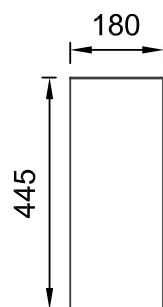

Art.Nr.:FBXATV

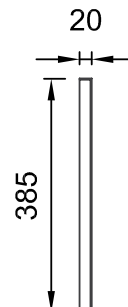

Art.Nr.:FBXATZ

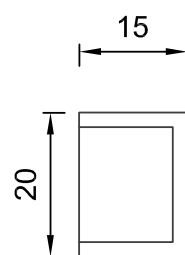

Art.Nr.:FBXAUD



QR-Code einfach scannen und
Austrotherm Materiallisten-Generator
online nutzen.

Austrotherm Brettprofil

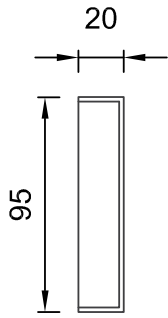

Art.Nr.:FBXAUF

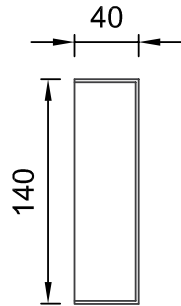

Art. Nr. FBXAUJ

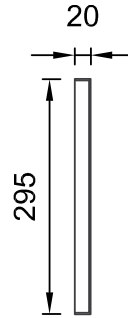

Art.Nr.: FBXAUN

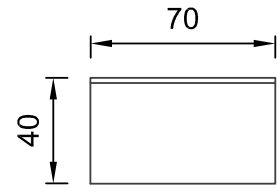

Art.Nr.: FBXAUS

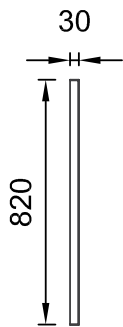

Art.Nr.:FBXAUG

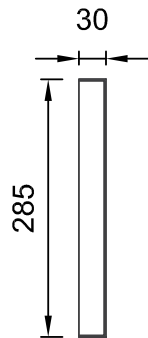

Art.Nr.: FBXAUK

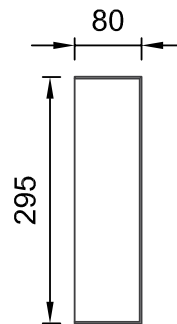

Art.Nr.: FBXAUN

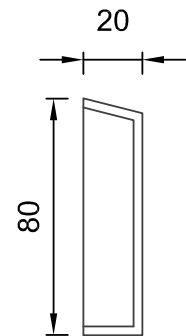

Art.Nr.: FBXAUN

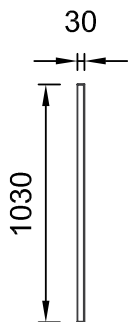

Art.Nr.:FBXAUN

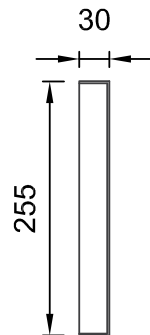

Art.Nr.: FBXAUN

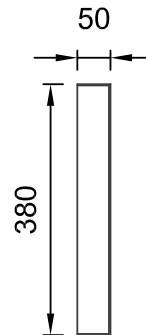

Art. Nr. FBXAUN

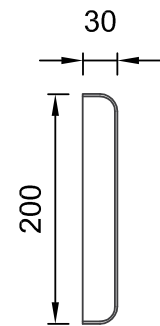

Art.Nr.: FBXAUN

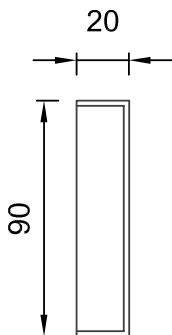

Art.Nr.: FBXAUN

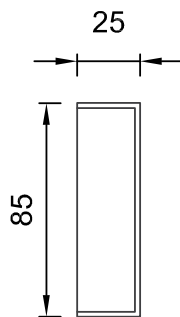

Art.Nr.: FBXAUN

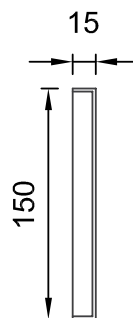

Art.Nr.: FBXAUN

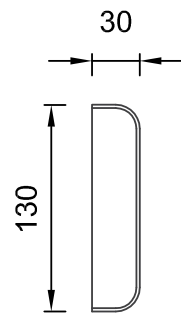

Art.Nr.: FBXAUN



QR-Code einfach scannen und
Austrotherm Materialisten-Generator
online nutzen.

Austrotherm Brettprofil

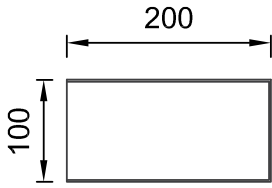

Art. Nr. FBXAUX

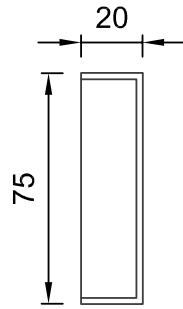

Art.Nr.: FBXAVC

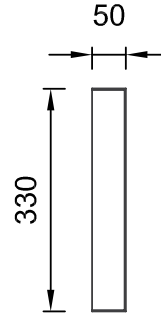

Art.Nr.: FBXAVG

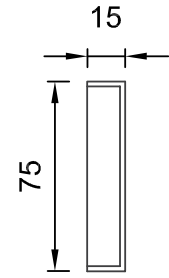

Art.Nr.: FBXAVP

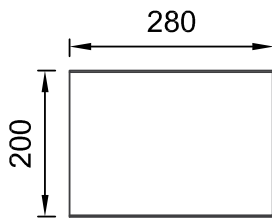

Art.Nr.: FBXAUY

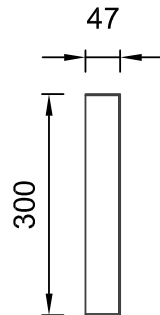

Art.Nr.: FBXAVD

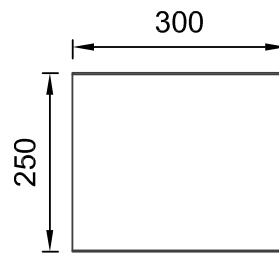

Art.Nr.: FBXAVH

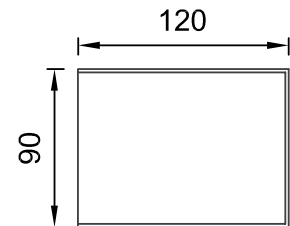

Art.Nr.: FBXAVQ

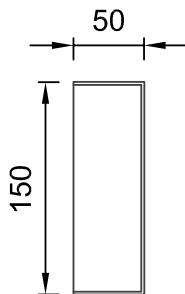

Art.Nr.: FBXAUZ

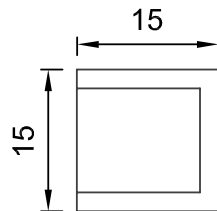

Art.Nr.: FBXAVE

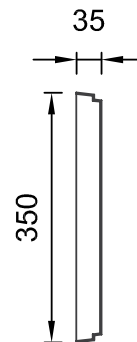

Art.Nr.: FBXAVN

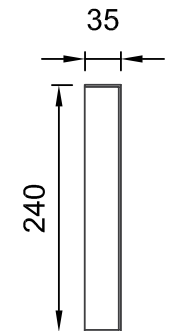

Art.Nr.: FBXAVR

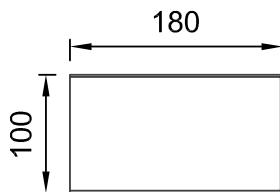

Art.Nr.: FBXAVB

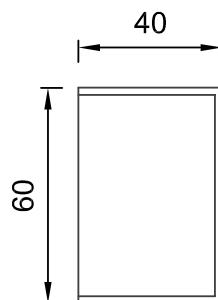

Art.Nr.: FBXAVF

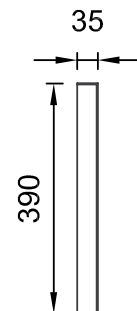

Art.Nr.: FBXAVO



QR-Code einfach scannen und
Austrotherm Materialisten-Generator
online nutzen.

Austrotherm Gesimseprofil

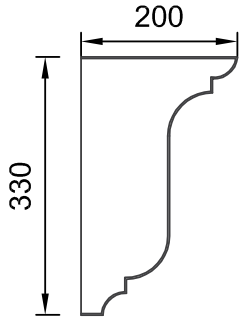

Art.Nr.: FGXAAA

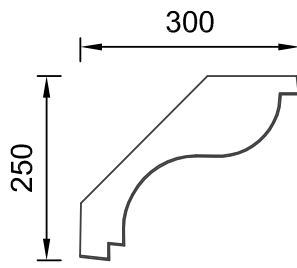

Art.Nr.: FGXAAE

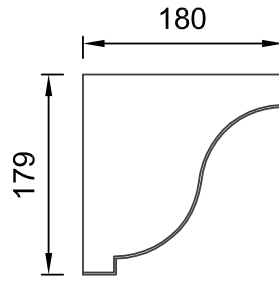

Art.Nr.: FGXAAJ

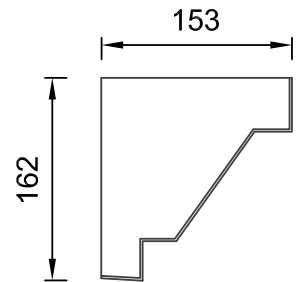

Art.Nr.: FGXAAN

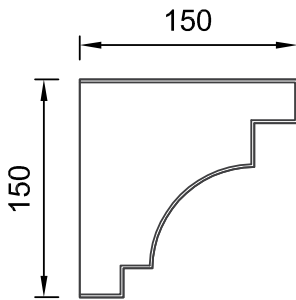

Art.Nr.: FGXAAB

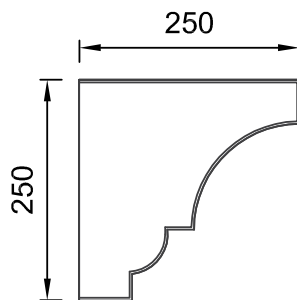

Art.Nr.: FGXAAG

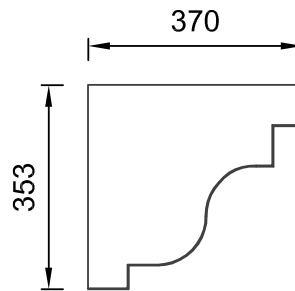

Art.Nr.: FGXAAK

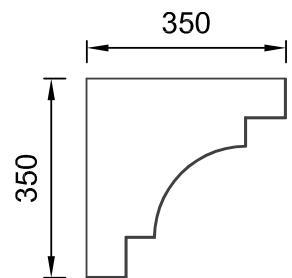

Art.Nr.: FGXA AO

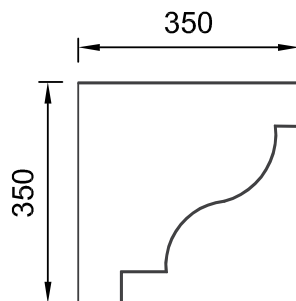

Art.Nr.: FGXAAC

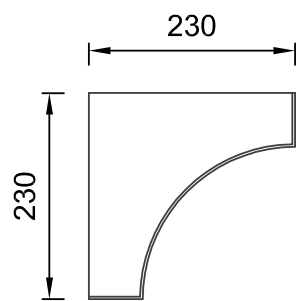

Art.Nr.: FGXA AH

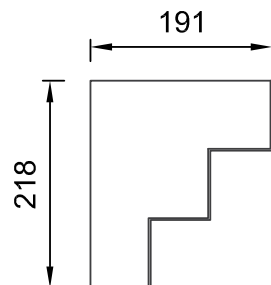

Art.Nr.: FGXAAL

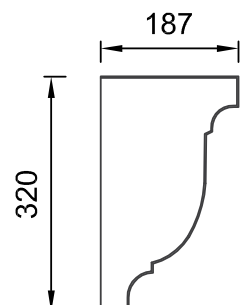

Art.Nr.: FGXAAP

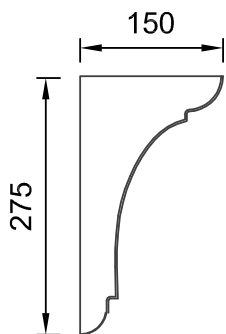

Art.Nr.: FGXAAD

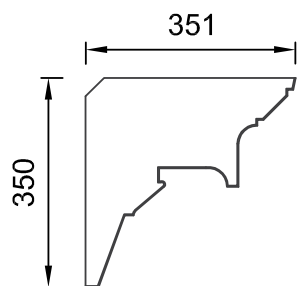

Art.Nr.: FGXA AI

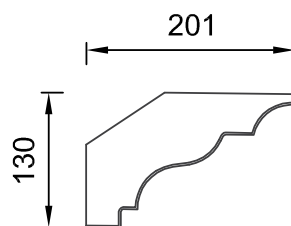

Art.Nr.: FGXAAM

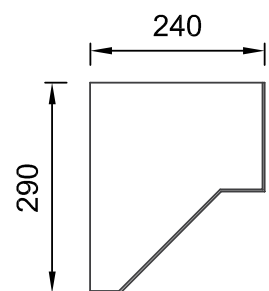

Art.Nr.: FGXA AQ



QR-Code einfach scannen und
Austrotherm Materiallisten-Generator
online nutzen.

Austrotherm Gesimseprofil

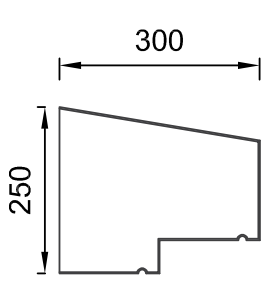

Art.Nr.: FGXAAR

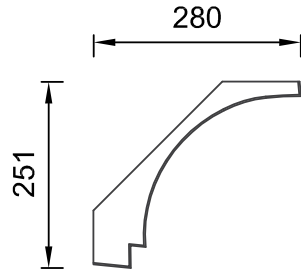

Art.Nr.: FGXAAV

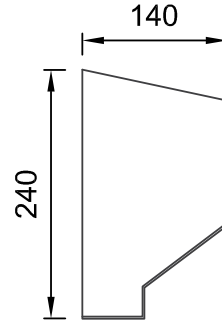

Art.Nr.: FGXAAZ

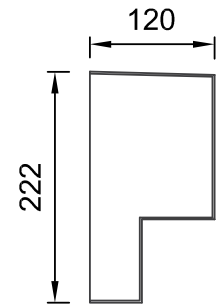

Art.Nr.: FGXABD

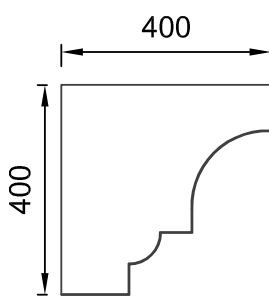

Art.Nr.: FGXAAS

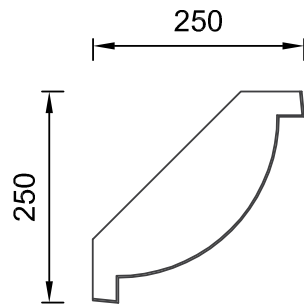

Art.Nr.: FGXAAW

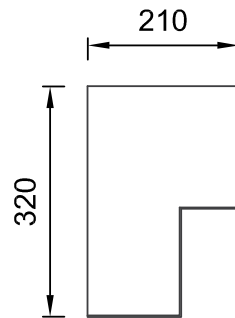

Art.Nr.: FGXABA

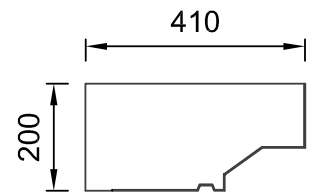

Art.Nr.: FGXABE

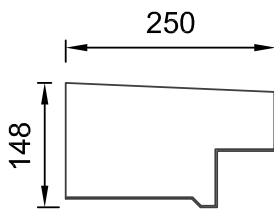

Art.Nr.: FGXAAT

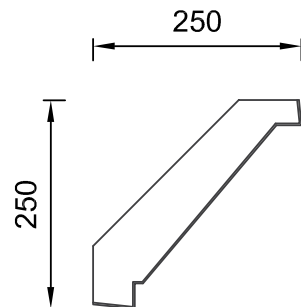

Art.Nr.: FGXAAX

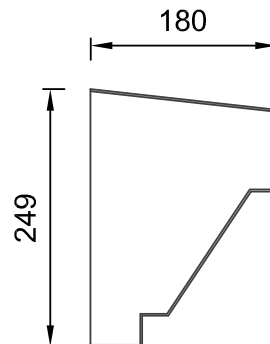

Art.Nr.: FGXABB

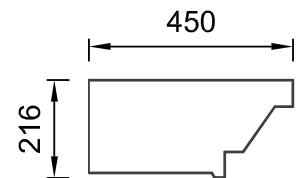

Art.Nr.: FGXABF

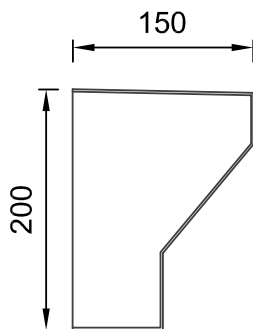

Art.Nr.: FGXAAU

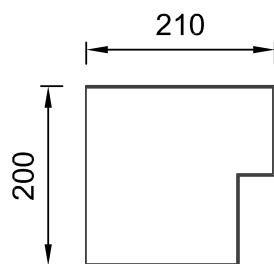

Art.Nr.: FGXAAV

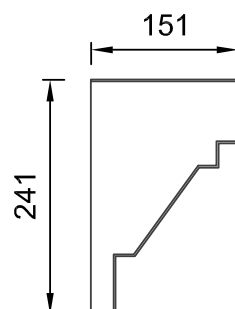

Art.Nr.: FGXABC

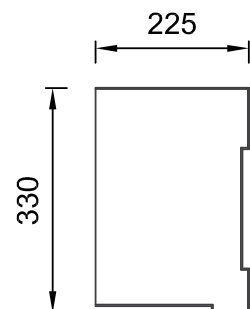

Art.Nr.: FGXABG



QR-Code einfach scannen und
Austrotherm Materiallisten-Generator
online nutzen.

Austrotherm Gesimseprofil

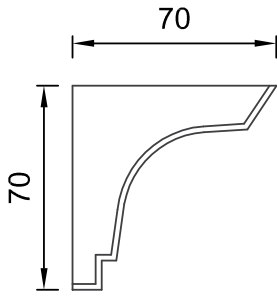

Art.Nr.: FGXABH

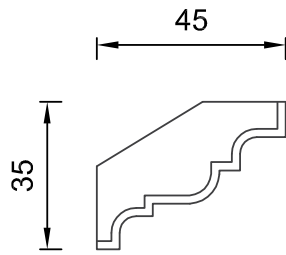

Art.Nr.: FGXABL

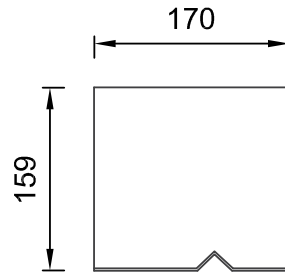

Art.Nr.: FGXABP

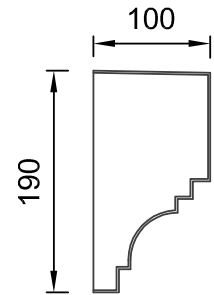

Art.Nr.: FGXABT

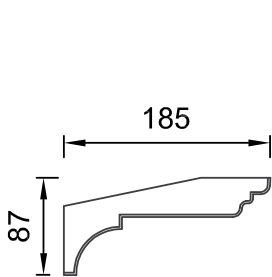

Art.Nr.: FGXABI

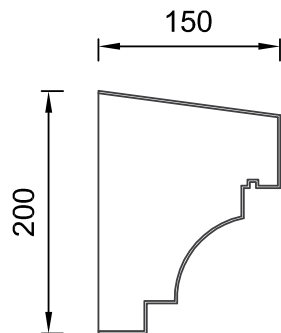

Art.Nr.: FGXABM

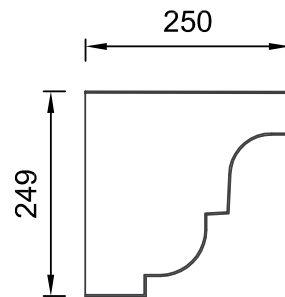

Art.Nr.: FGXABQ

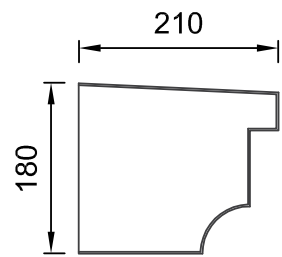

Art.Nr.: FGXABU

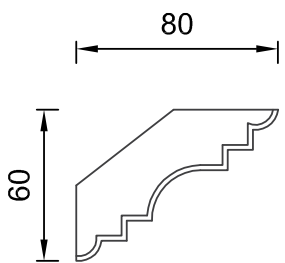

Art.Nr.: FGXABJ

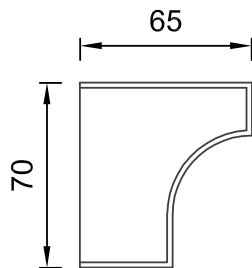

Art.Nr.: FGXABN

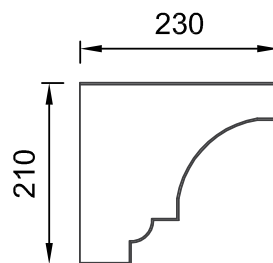

Art.Nr.: FGXABR

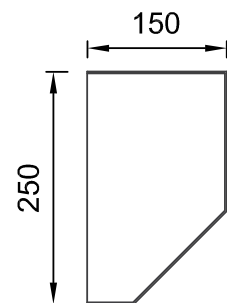

Art.Nr.: FGXABV

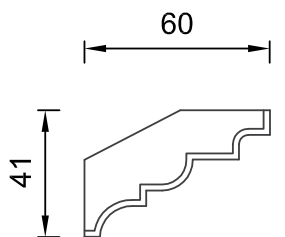

Art.Nr.: FGXABK

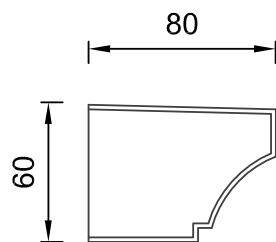

Art.Nr.: FGXABO

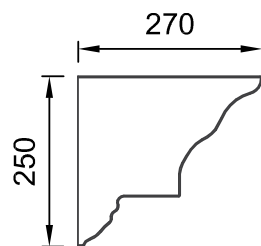

Art.Nr.: FGXABS

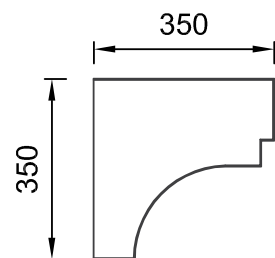

Art.Nr.: FGXABW



QR-Code einfach scannen und
Austrotherm Materiallisten-Generator
online nutzen.

Austrotherm Gesimseprofil

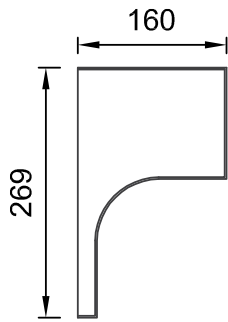

Art.Nr.: FGXABX

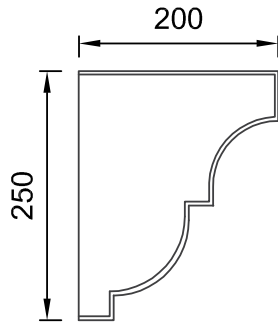

Art.Nr.: FGXACB

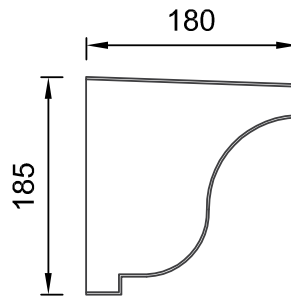

Art.Nr.: FGXACF

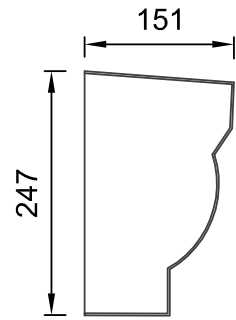

Art.Nr.: FGXACJ

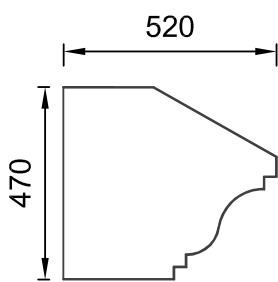

Art.Nr.: FGXABY

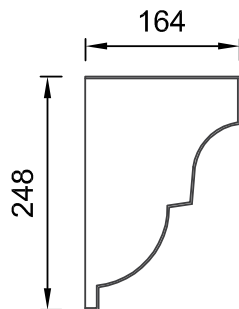

Art.Nr.: FGXACC

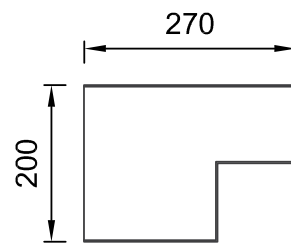

Art.Nr.: FGXACG

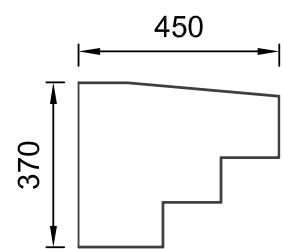

Art.Nr.: FGXACK

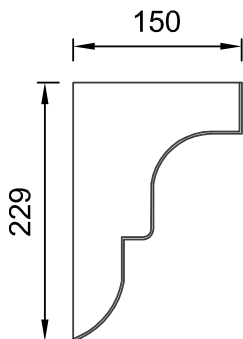

Art.Nr.: FGXABZ

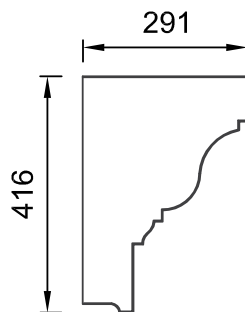

Art.Nr.: FGXACD

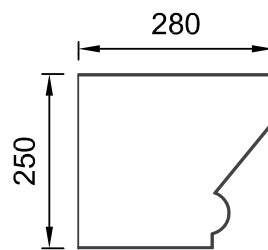

Art.Nr.: FGXACH

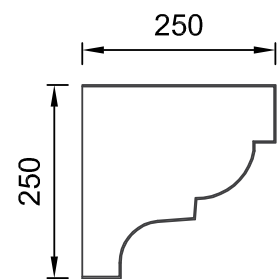

Art.Nr.: FGXACL

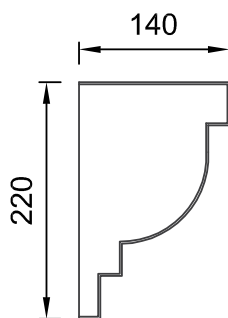

Art.Nr.: FGXACA

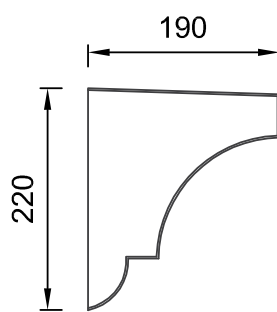

Art.Nr.: FGXACE

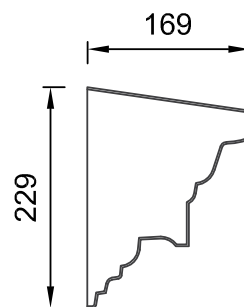

Art.Nr.: FGXACI

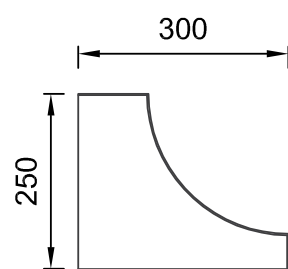

Art.Nr.: FGXACM



QR-Code einfach scannen und
Austrotherm Materiallisten-Generator
online nutzen.

Austrotherm Gesimseprofil

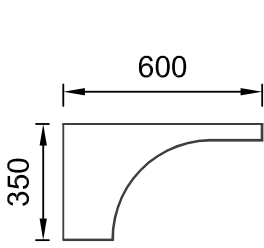

Art.Nr.: FGXACN

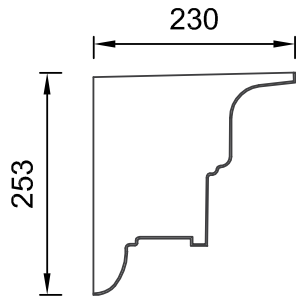

Art.Nr.: FGXACR

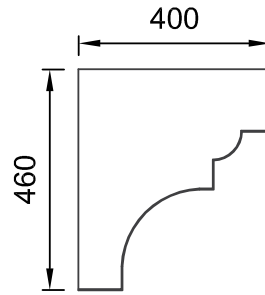

Art.Nr.: FGXACV

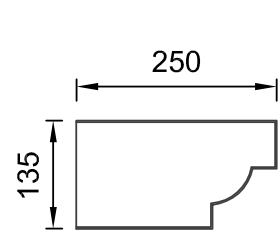

Art.Nr.: FGXACZ

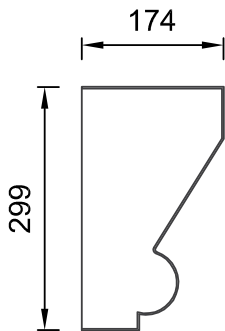

Art.Nr.: FGXACO

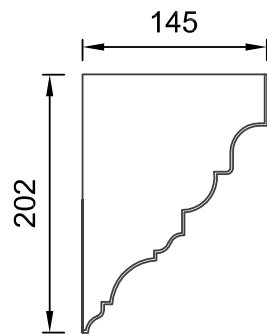

Art.Nr.: FGXACS

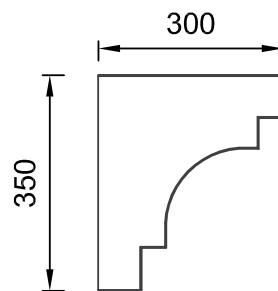

Art.Nr.: FGXACW

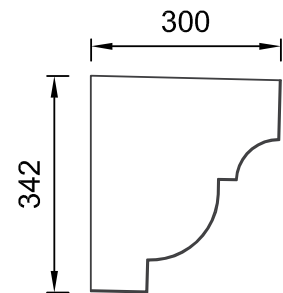

Art.Nr.: FGXADA

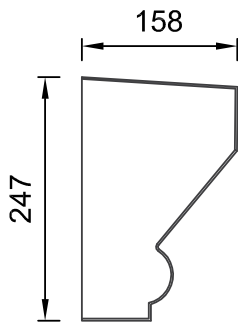

Art.Nr.: FGXACP

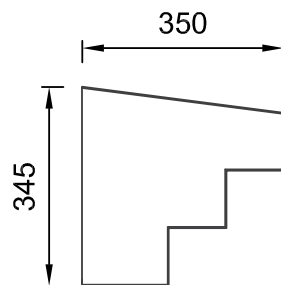

Art.Nr.: FGXACT

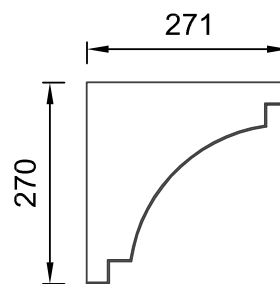

Art.Nr.: FGXACX

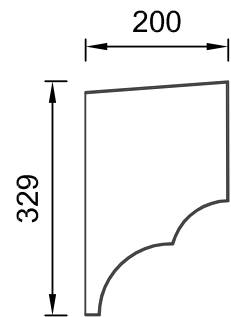

Art.Nr.: FGXADB

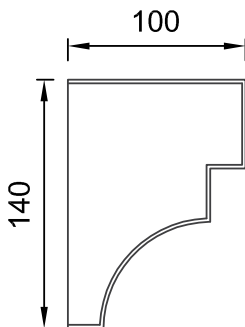

Art.Nr.: FGXACQ

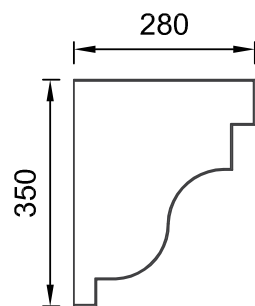

Art.Nr.: FGXACU

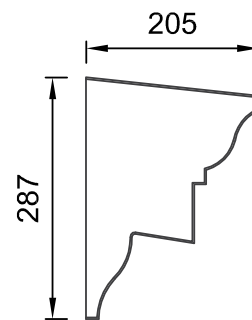

Art.Nr.: FGXACY

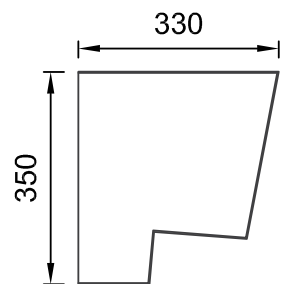

Art.Nr.: FGXADC



QR-Code einfach scannen und
Austrotherm Materialisten-Generator
online nutzen.

Austrotherm Gesimseprofil

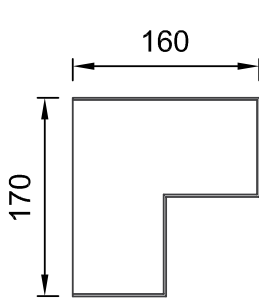

Art.Nr.: FGXADD

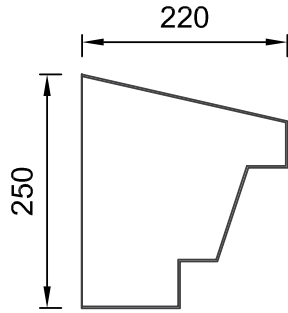

Art.Nr.: FGXADH

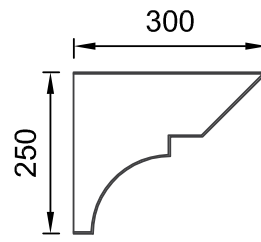

Art.Nr.: FGXADL

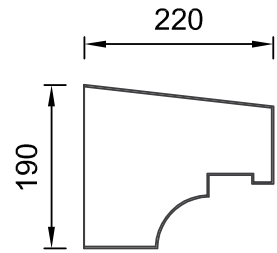

Art.Nr.: FGXADP

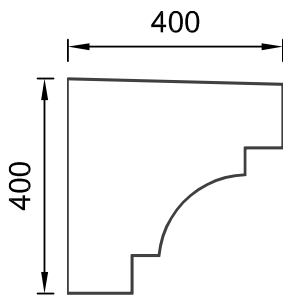

Art.Nr.: FGXADE

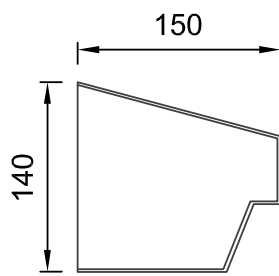

Art.Nr.: FGXADI

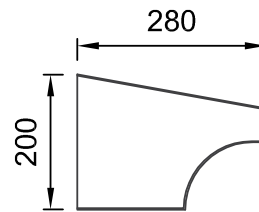

Art.Nr.: FGXADM

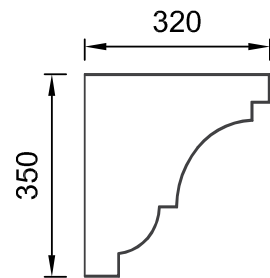

Art.Nr.: FGXADQ

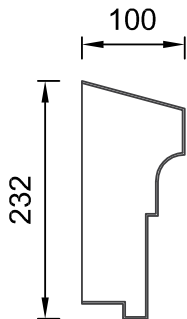

Art.Nr.: FGXADF

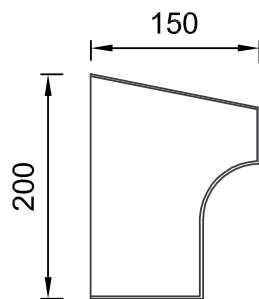

Art.Nr.: FGXADJ

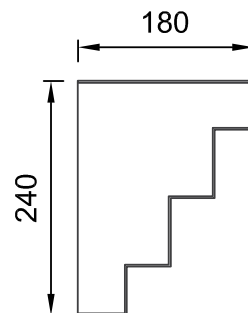

Art.Nr.: FGXADN

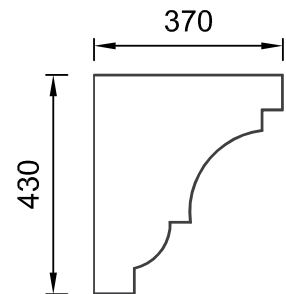

Art.Nr.: FGXADR

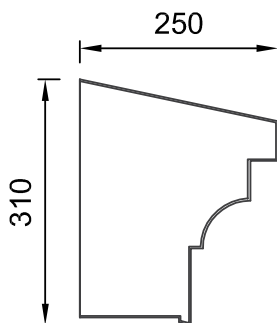

Art.Nr.: FGXADG

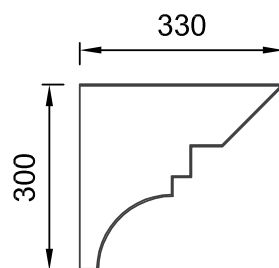

Art.Nr.: FGXADK

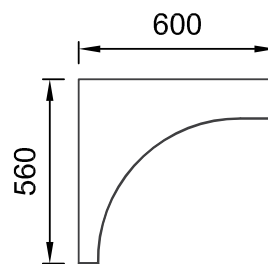

Art.Nr.: FGXADO

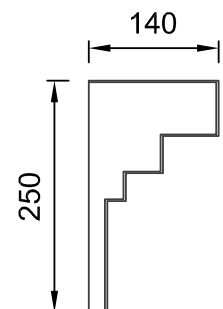

Art.Nr.: FGXADS



QR-Code einfach scannen und
Austrotherm Materiallisten-Generator
online nutzen.

Austrotherm Gesimseprofil

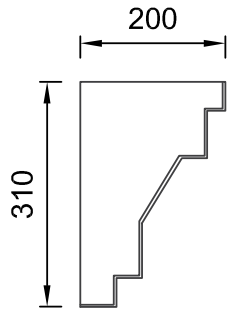

Art.Nr.: FGXADT

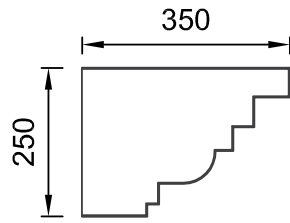

Art.Nr.: FGXADX

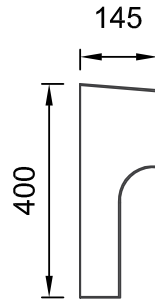

Art.Nr.: FGXAEB

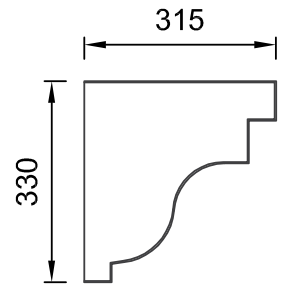

Art.Nr.: FGXAEF

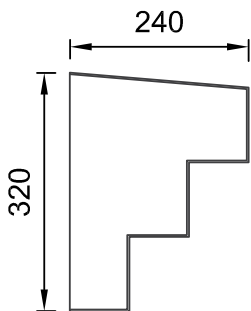

Art.Nr.: FGXADU

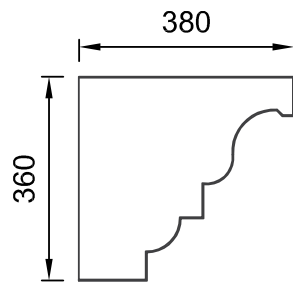

Art.Nr.: FGXADY

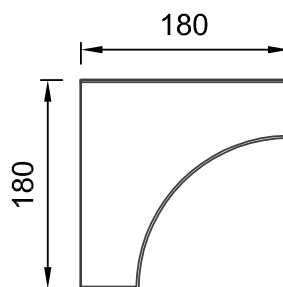

Art.Nr.: FGXAEC

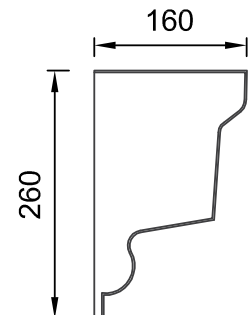

Art.Nr.: FGXAEG

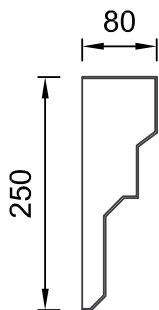

Art.Nr.: FGXADV

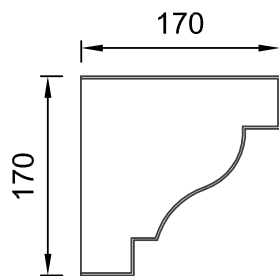

Art.Nr.: FGXADZ

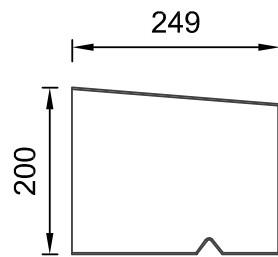

Art.Nr.: FGXAED

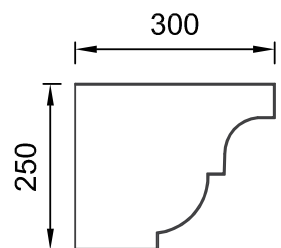

Art.Nr.: FGXAEH

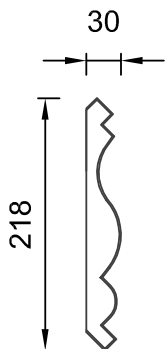

Art.Nr.: FGXADW

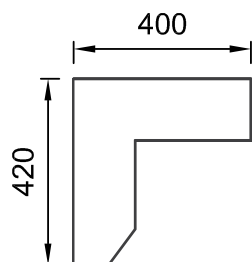

Art.Nr.: FGXAEA

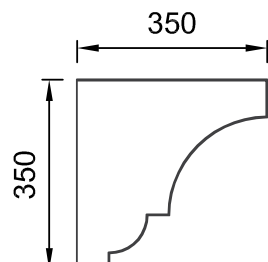

Art.Nr.: FGXAEE

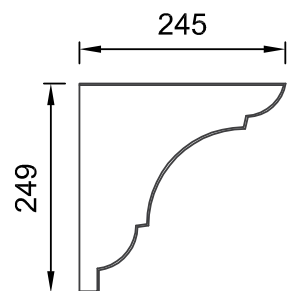

Art.Nr.: FGXA EI



QR-Code einfach scannen und
Austrotherm Materiallisten-Generator
online nutzen.

Austrotherm Gesimseprofil

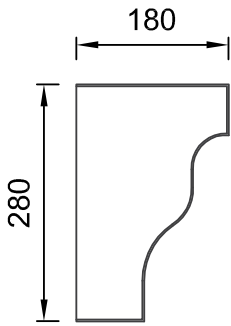

Art.Nr.: FGXAEJ

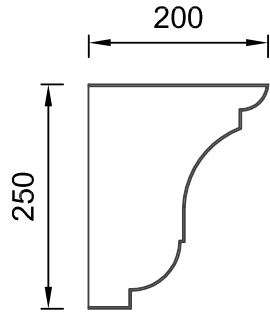

Art.Nr.: FGXAEN

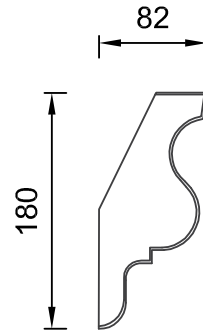

Art.Nr.: FGXAER

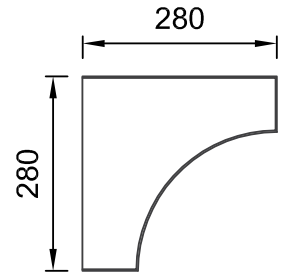

Art.Nr.: FGXAEV

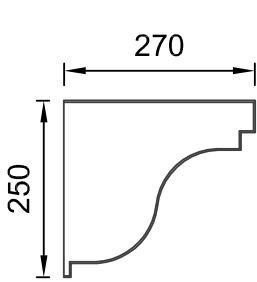

Art.Nr.: FGXAEK

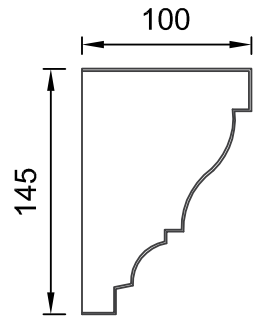

Art.Nr.: FGXAE0

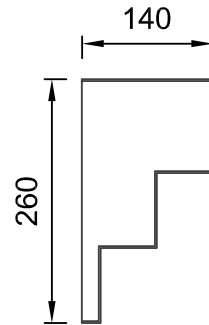

Art.Nr.: FGXAES

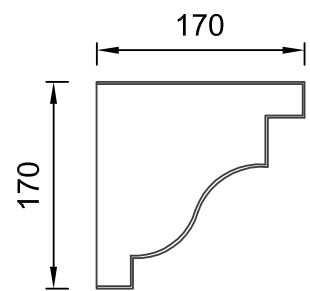

Art.Nr.: FGXAEW

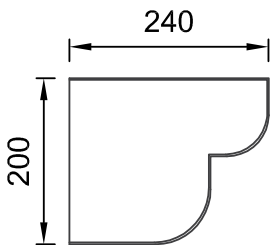

Art.Nr.: FGXAEL

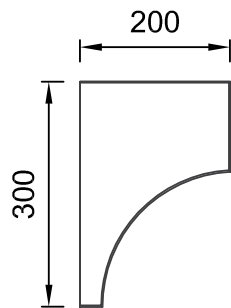

Art.Nr.: FGXAEP

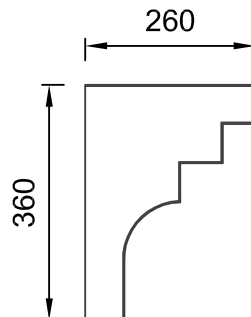

Art.Nr.: FGXAET

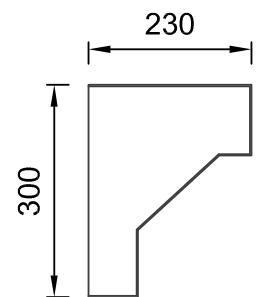

Art.Nr.: FGXAEX

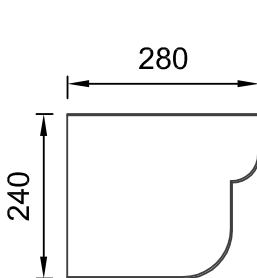

Art.Nr.: FGXAEM

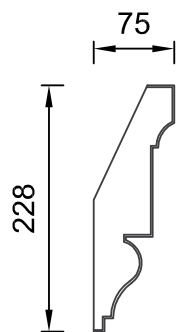

Art.Nr.: FGXAEQ

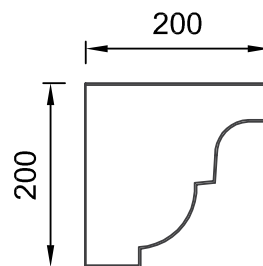

Art.Nr.: FGXAEU

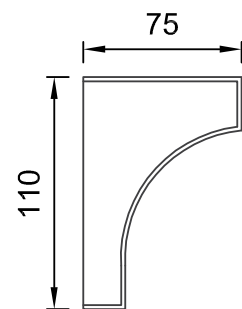

Art.Nr.: FGXAEY



QR-Code einfach scannen und
Austrotherm Materiallisten-Generator
online nutzen.

Austrotherm Gesimseprofil

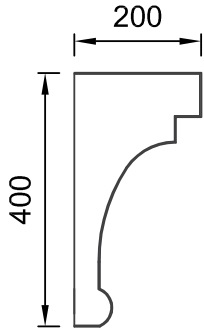

Art.Nr.: FGXAEZ

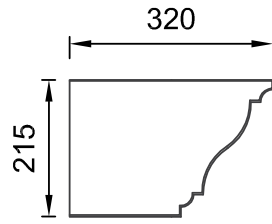

Art.Nr.: FGXAFD

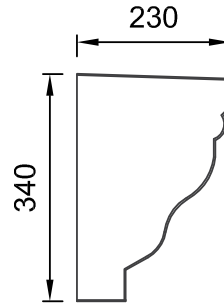

Art.Nr.: FGXAFH

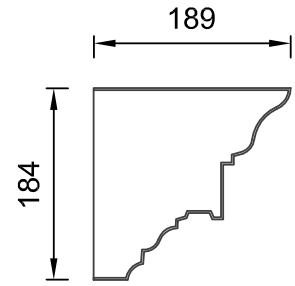

Art.Nr.: FGXAFL

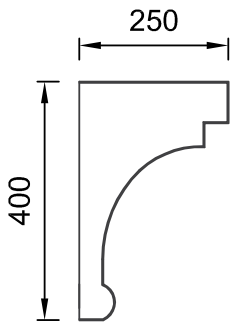

Art.Nr.: FGXAFA

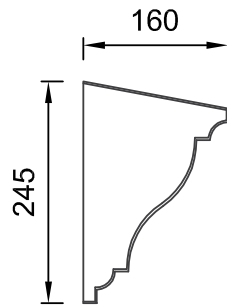

Art.Nr.: FGXAFE

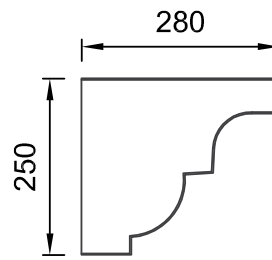

Art.Nr.: FGXAFI

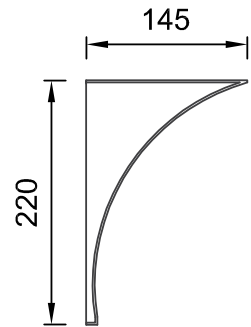

Art.Nr.: FGXAFM

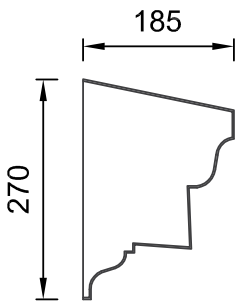

Art.Nr.: FGXAFB

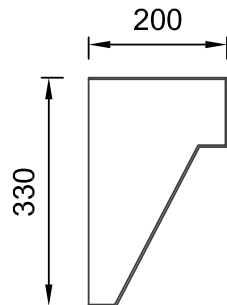

Art.Nr.: FGXAFF

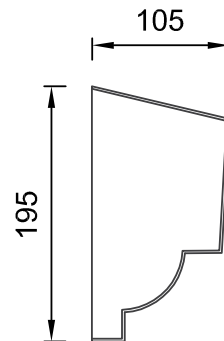

Art.Nr.: FGXAFJ

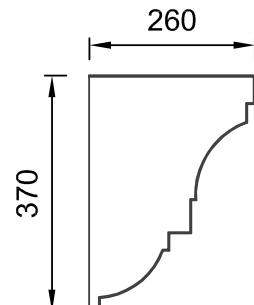

Art.Nr.: FGXAFN

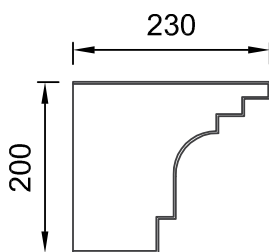

Art.Nr.: FGXAFC

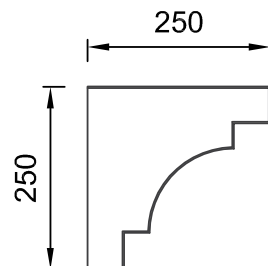

Art.Nr.: FGXAFG

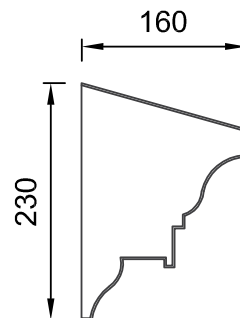

Art.Nr.: FGXAFK

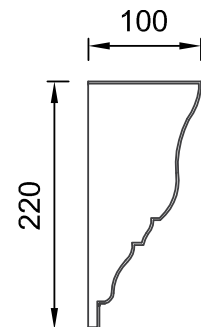

Art.Nr.: FGXAFO



QR-Code einfach scannen und
Austrotherm Materiallisten-Generator
online nutzen.

Austrotherm Gesimseprofil

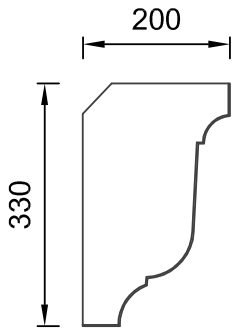

Art.Nr.: FGXAFF

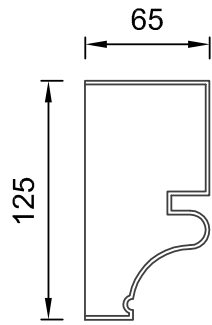

Art.Nr.: FGXAFT

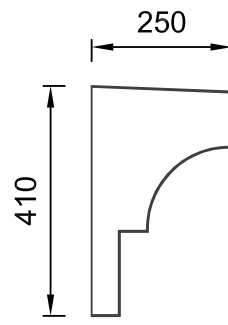

Art.Nr.: FGXAFX

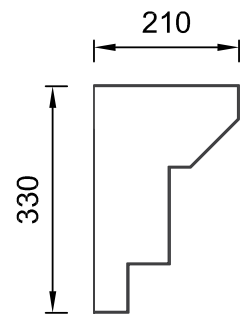

Art.Nr.: FGXAGB

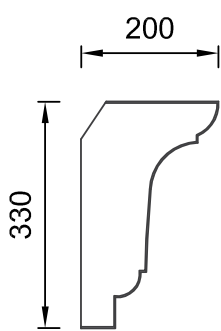

Art.Nr.: FGXAFQ

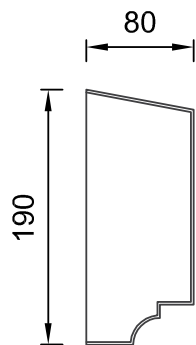

Art.Nr.: FGXAFU

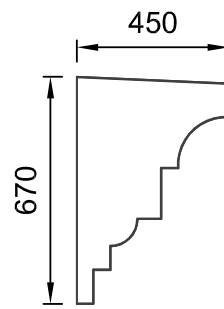

Art.Nr.: FGXAFY

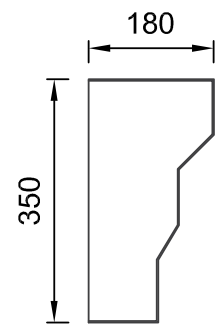

Art.Nr.: FGXAGC

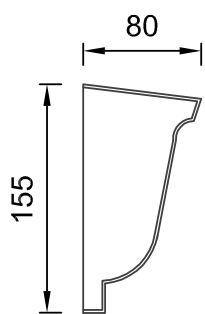

Art.Nr.: FGXAFR

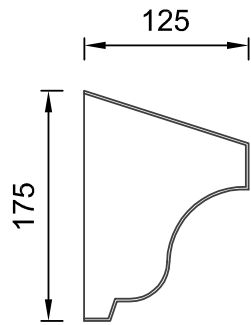

Art.Nr.: FGXAFV

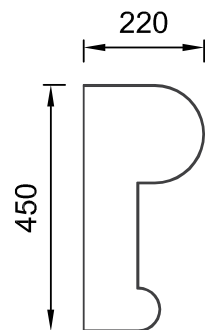

Art.Nr.: FGXAFZ

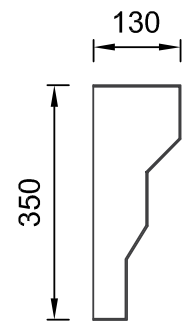

Art.Nr.: FGXAGD

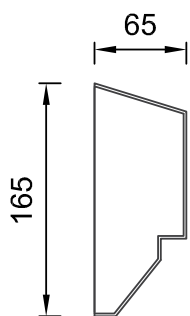

Art.Nr.: FGXAFS

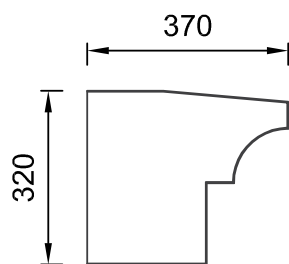

Art.Nr.: FGXAFW

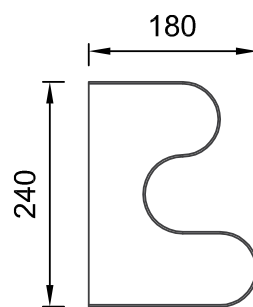

Art.Nr.: FGXAGA

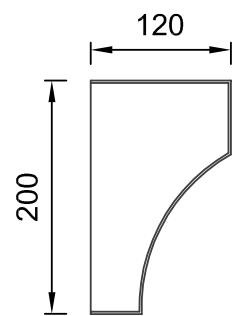

Art.Nr.: FGXAGE



QR-Code einfach scannen und
Austrotherm Materiallisten-Generator
online nutzen.

Austrotherm Gesimseprofil

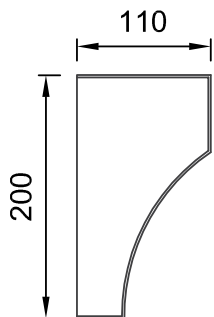

Art.Nr.: FGXAGF

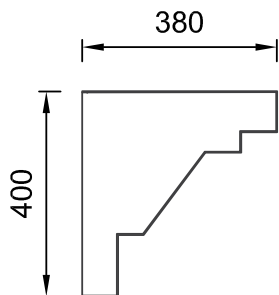

Art.Nr.: FGXAGK

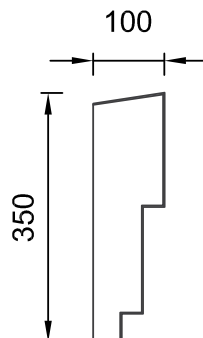

Art.Nr.: FGXAGO

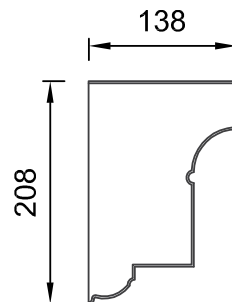

Art.Nr.: FGXAGS

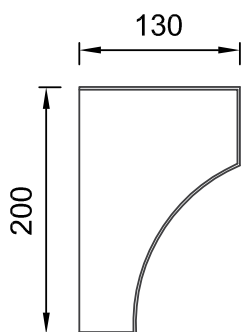

Art.Nr.: FGXAGG

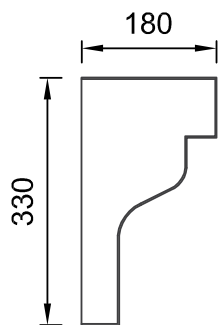

Art.Nr.: FGXAGL

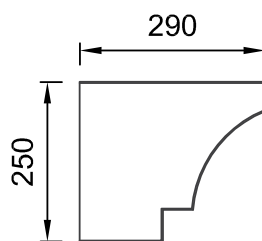

Art.Nr.: FGXAGP

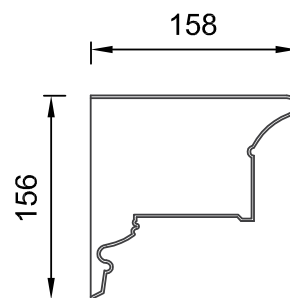

Art.Nr.: FGXAGT

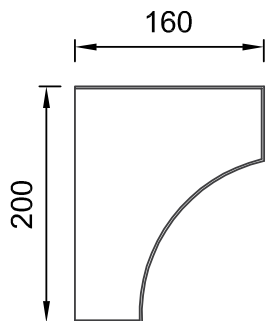

Art.Nr.: FGXAGH

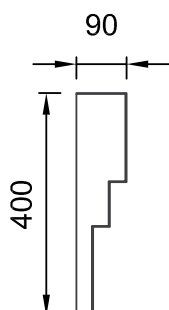

Art.Nr.: FGXAGM

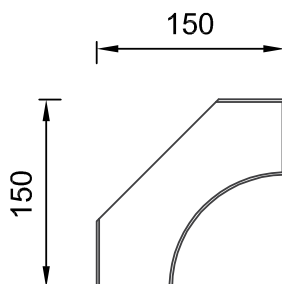

Art.Nr.: FGXAGQ

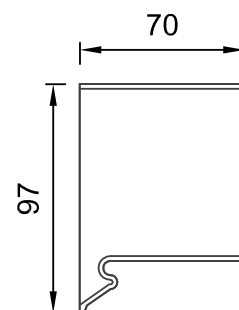

Art.Nr.: FGXAGU

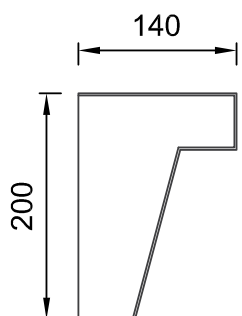

Art.Nr.: FGXAGJ

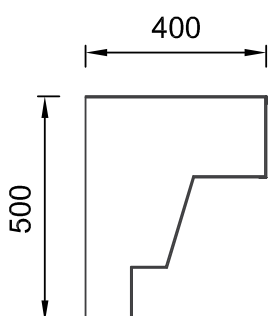

Art.Nr.: FGXAGN

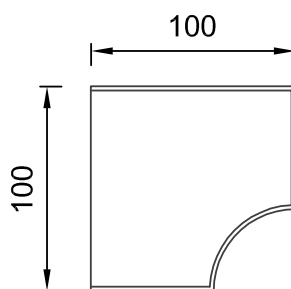

Art.Nr.: FGXAGR

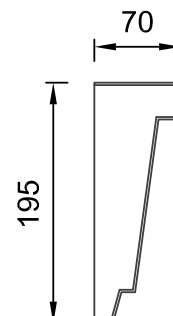

Art.Nr.: FGXAGV



QR-Code einfach scannen und
Austrotherm Materiallisten-Generator
online nutzen.

Austrotherm Gesimseprofil

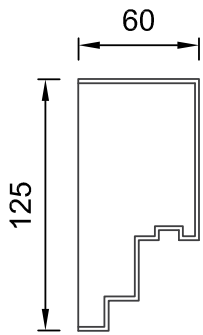

Art.Nr.: FGXAGW

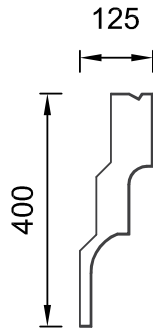

Art.Nr.: FGXAHA

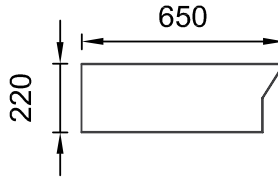

Art.Nr.: FGXAHE

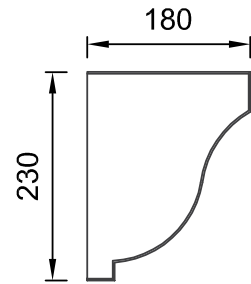

Art.Nr.: FGXAHI

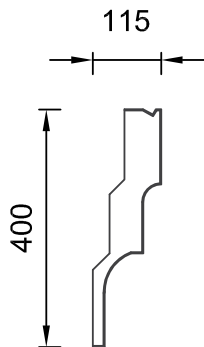

Art.Nr.: FGXAGX

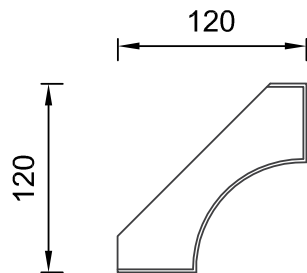

Art.Nr.: FGXAHB

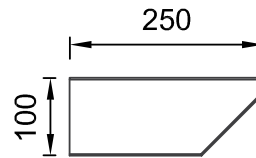

Art.Nr.: FGXAHF

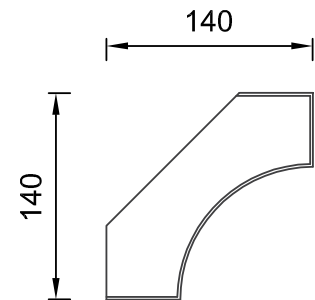

Art.Nr.: FGXAHJ

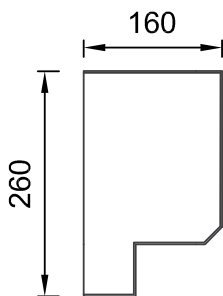

Art.Nr.: FGXAGY

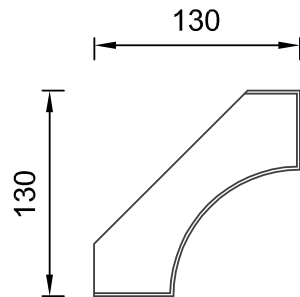

Art.Nr.: FGXAHC

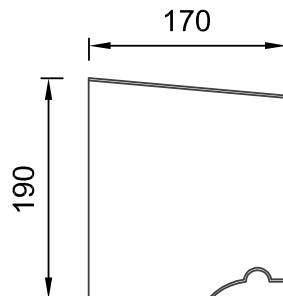

Art.Nr.: FGXAHG

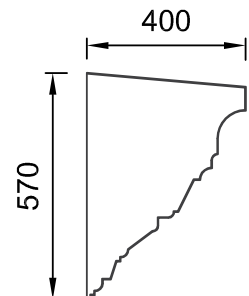

Art.Nr.: FGXAHK

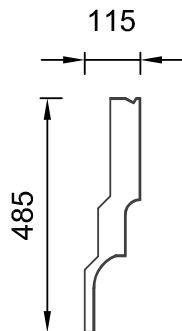

Art.Nr.: FGXAGZ

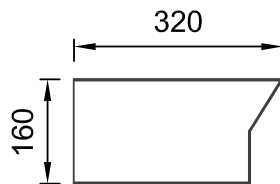

Art.Nr.: FGXAHD

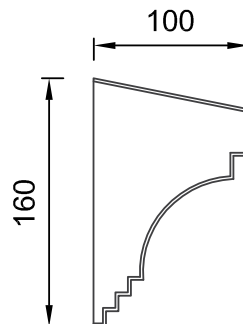

Art.Nr.: FGXAHH

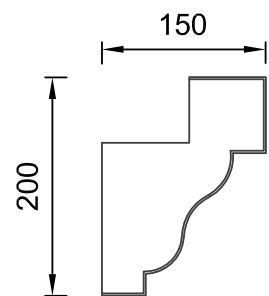

Art.Nr.: FGXAHL



QR-Code einfach scannen und
Austrotherm Materiallisten-Generator
online nutzen.

Austrotherm Gesimseprofil

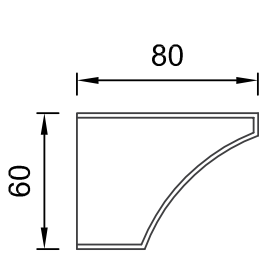

Art.Nr.: FGXAHM

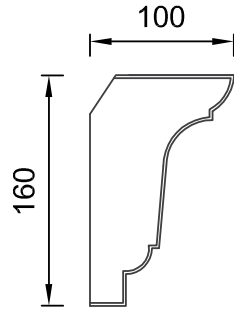

Art.Nr.: FGXAHQ

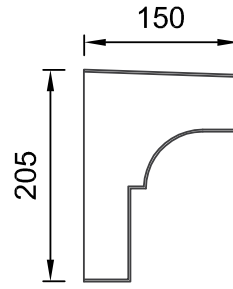

Art.Nr.: FGXAHU

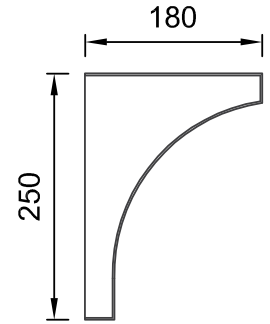

Art.Nr.: FGXAHY

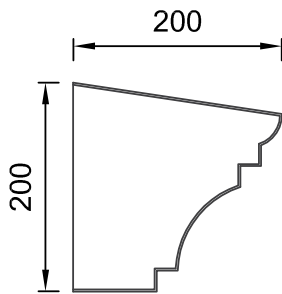

Art.Nr.: FGXAHN

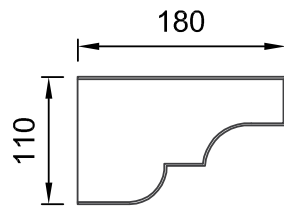

Art.Nr.: FGXAHR

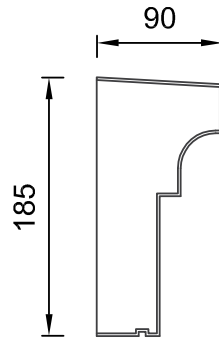

Art.Nr.: FGXAHV

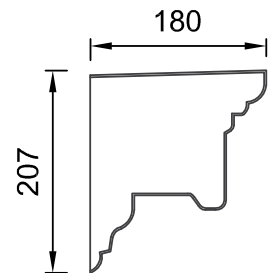

Art.Nr.: FGXAHZ

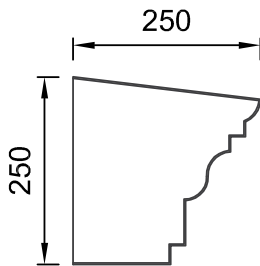

Art.Nr.: FGXAHO

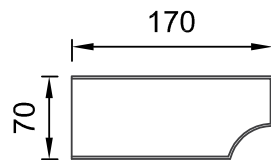

Art.Nr.: FGXAHS

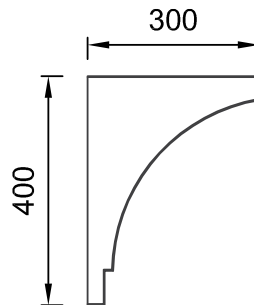

Art.Nr.: FGXAHW

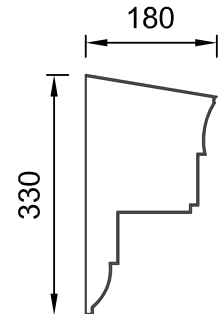

Art.Nr.: FGXAIA

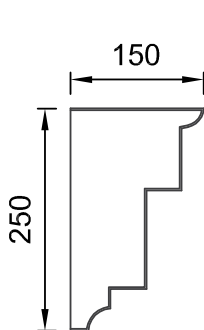

Art.Nr.: FGXAHP

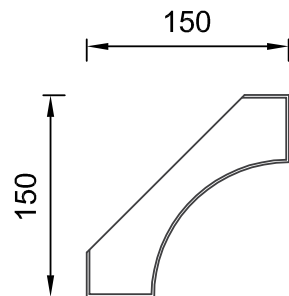

Art.Nr.: FGXAHT

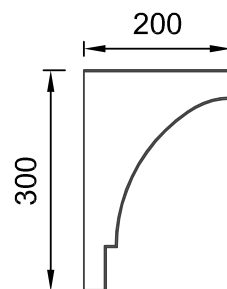

Art.Nr.: FGXAHX

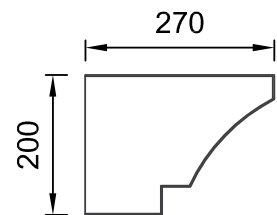

Art.Nr.: FGXAIB



QR-Code einfach scannen und
Austrotherm Materiallisten-Generator
online nutzen.

Austrotherm Gesimseprofil

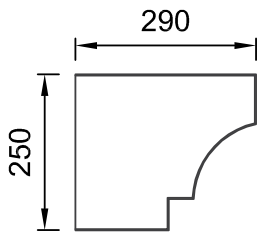

Art.Nr.: FGXAIC

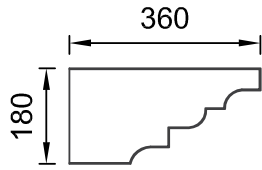

Art.Nr.: FGXAIG

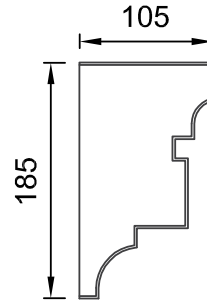

Art.Nr.: FGXAIK

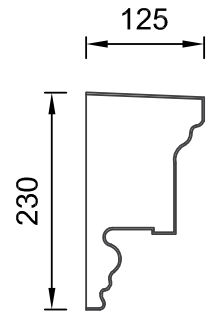

Art.Nr.: FGXAIO

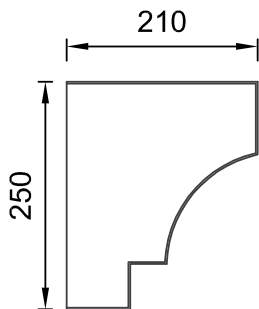

Art.Nr.: FGXAID

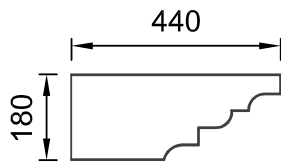

Art.Nr.: FGXAIH

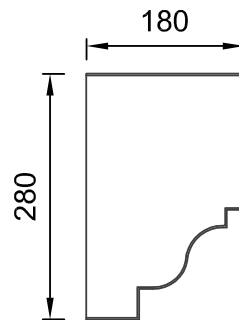

Art.Nr.: FGXAIL

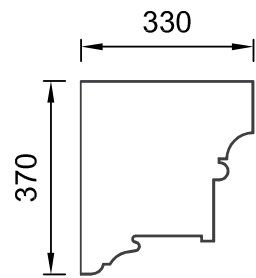

Art.Nr.: FGXAIP

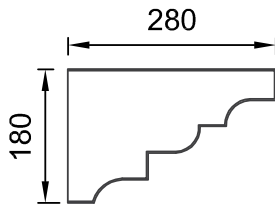

Art.Nr.: FGXAIE

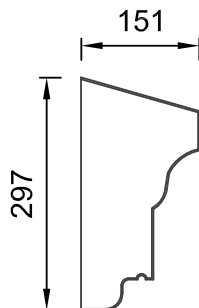

Art.Nr.: FGXAIL

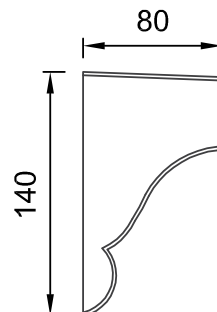

Art.Nr.: FGXAIM

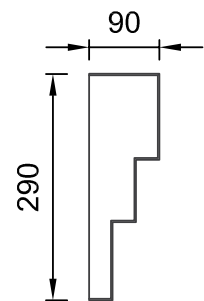

Art.Nr.: FGXAIQ

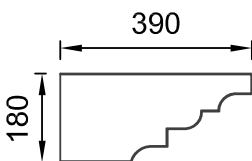

Art.Nr.: FGXAIF

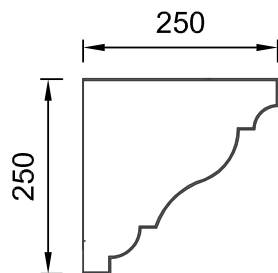

Art.Nr.: FGXAIJ

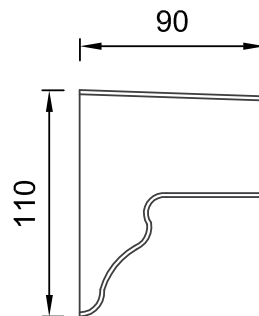

Art.Nr.: FGXAIN

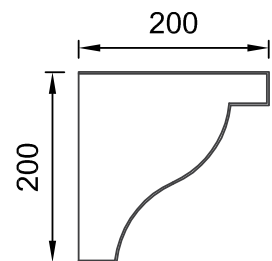

Art.Nr.: FGXAIR



QR-Code einfach scannen und
Austrotherm Materiallisten-Generator
online nutzen.

Austrotherm Gesimseprofil

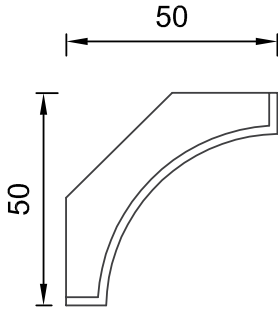

Art.Nr.: FGXAIS

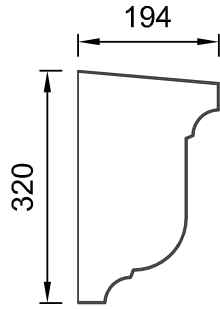

Art.Nr.: FGXAIW

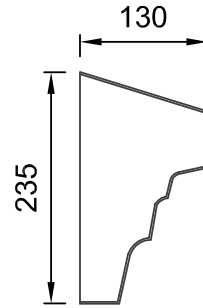

Art.Nr.: FGXAJA

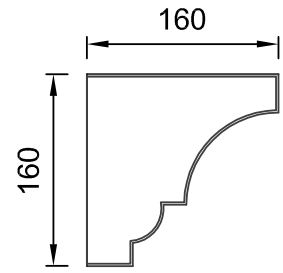

Art.Nr.: FGXAJE

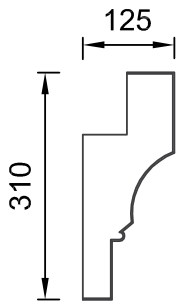

Art.Nr.: FGXAIT

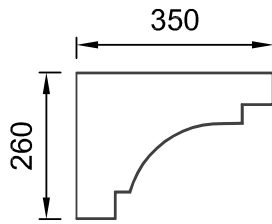

Art.Nr.: FGXAIX

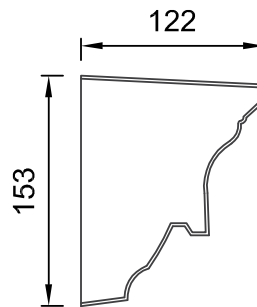

Art.Nr.: FGXAJB

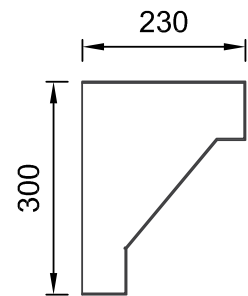

Art.Nr.: FGXAJF

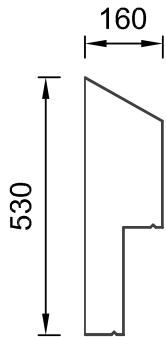

Art.Nr.: FGXAIU

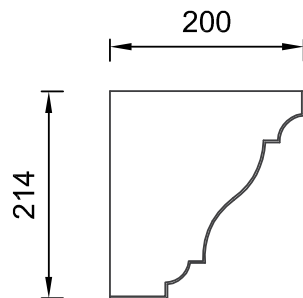

Art.Nr.: FGXAIV

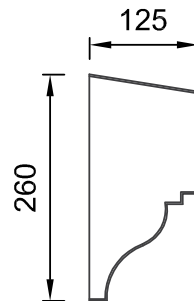

Art.Nr.: FGXAJC

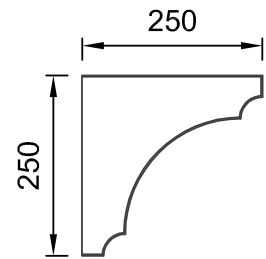

Art.Nr.: FGXAJG

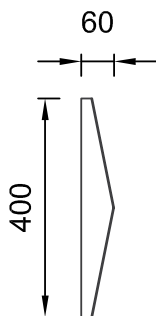

Art.Nr.: FGXAIV

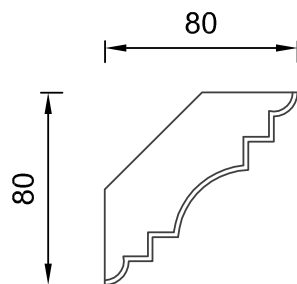

Art.Nr.: FGXAIZ

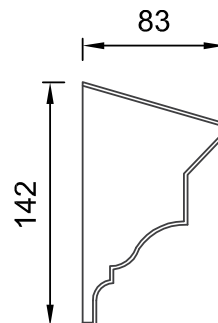

Art.Nr.: FGXAJD

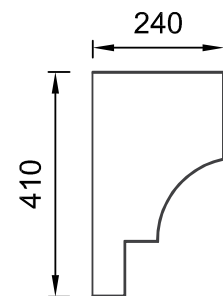

Art.Nr.: FGXAJH



QR-Code einfach scannen und
Austrotherm Materiallisten-Generator
online nutzen.

Austrotherm Gesimseprofil

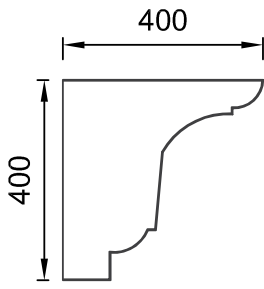

Art.Nr.: FGXAJI

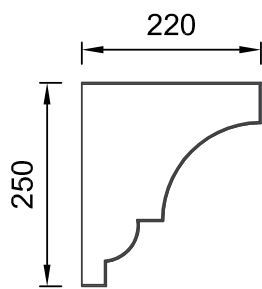

Art.Nr.: FGXAJM

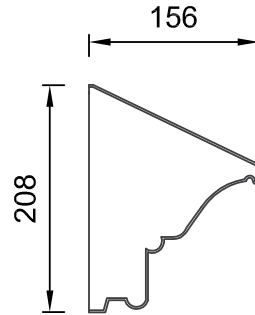

Art.Nr.: FGXAJQ

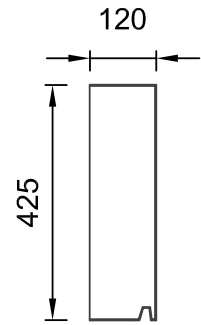

Art.Nr.: FGXAJU

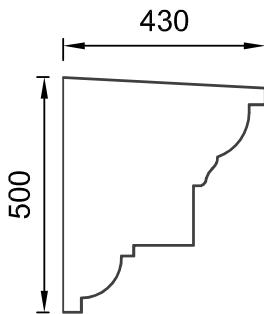

Art.Nr.: FGXAJJ

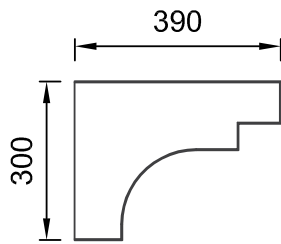

Art.Nr.: FGXAJN

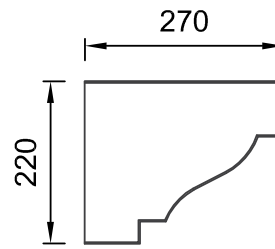

Art.Nr.: FGXAJR

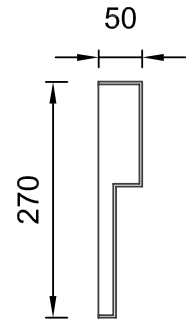

Art.Nr.: FGXAJV

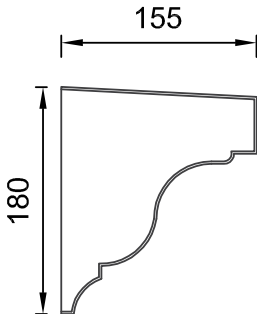

Art.Nr.: FGXAJK

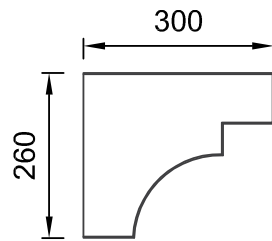

Art.Nr.: FGXAJO

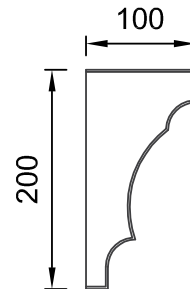

Art.Nr.: FGXAJS

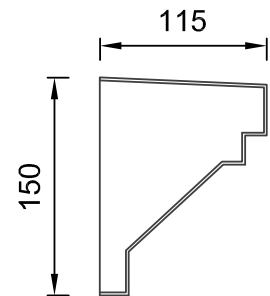

Art.Nr.: FGXAJW

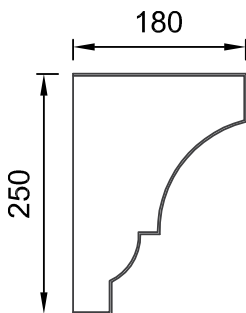

Art.Nr.: FGXAJL

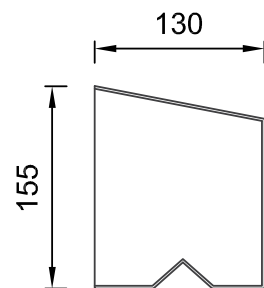

Art.Nr.: FGXAJP

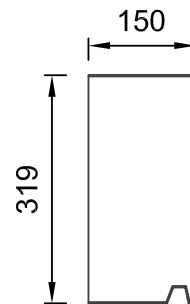

Art.Nr.: FGXAJT

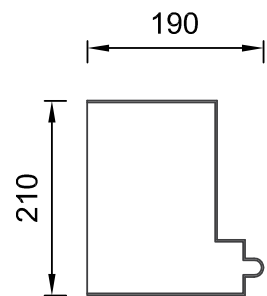

Art.Nr.: FGXAJX



QR-Code einfach scannen und
Austrotherm Materiallisten-Generator
online nutzen.

Austrotherm Gesimseprofil

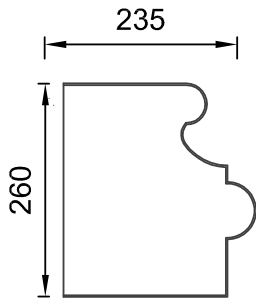

Art.Nr.: FGXAJY

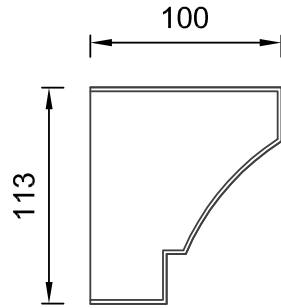

Art.Nr.: FGXAKC

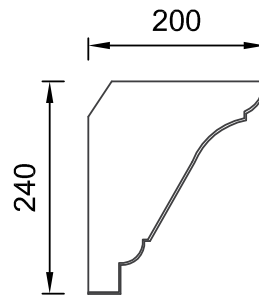

Art.Nr.: FGXAKG

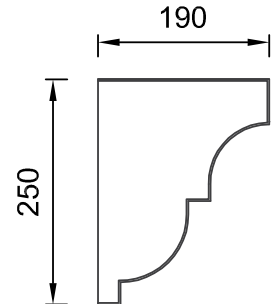

Art.Nr.: FGXAKP

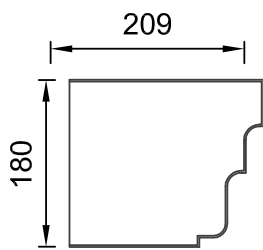

Art.Nr.: FGXAJZ

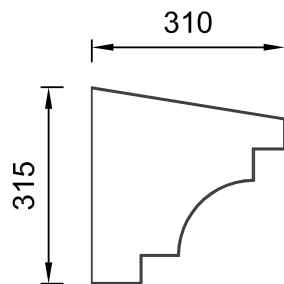

Art.Nr.: FGXAKD

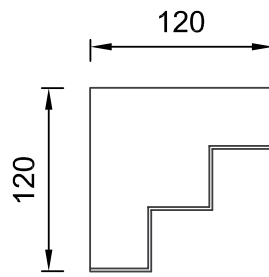

Art.Nr.: FGXAKH

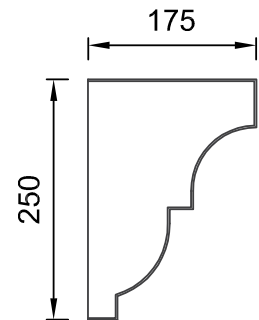

Art.Nr.: FGXAKQ

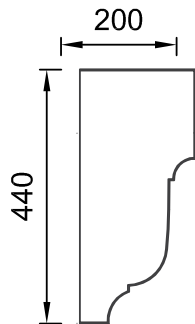

Art.Nr.: FGXAKA

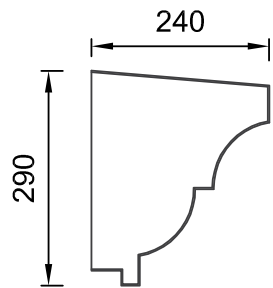

Art.Nr.: FGXAKE

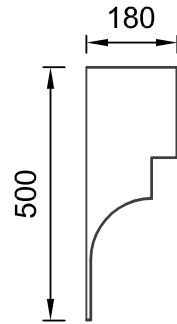

Art.Nr.: FGXAKI

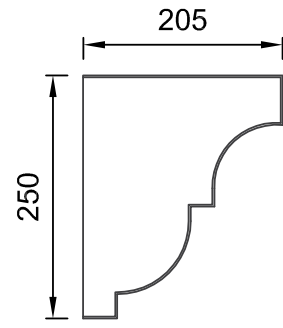

Art.Nr.: FGXAKR

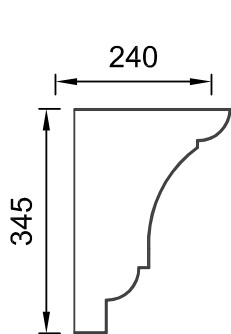

Art.Nr.: FGXAKB

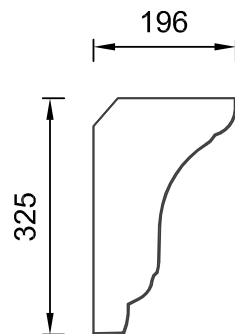

Art.Nr.: FGXAKF

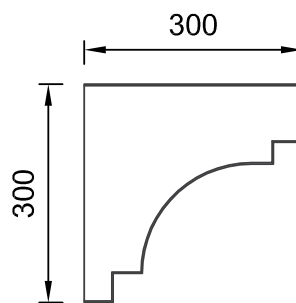

Art.Nr.: FGXAKL

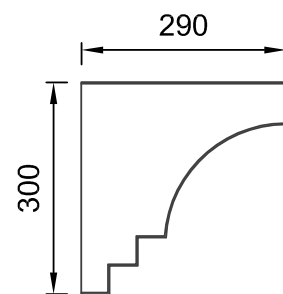

Art.Nr.: FGXAKS



QR-Code einfach scannen und
Austrotherm Materialisten-Generator
online nutzen.

Austrotherm Gesimseprofil

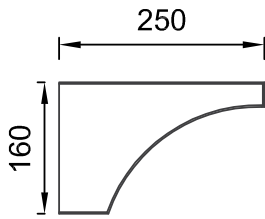

Art.Nr.: FGXAKY

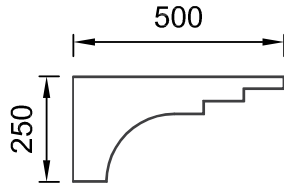

Art.Nr.: FGXALE

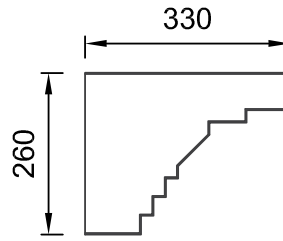

Art.Nr.: FGXALN

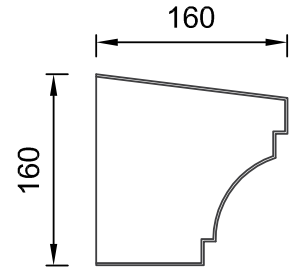

Art.Nr.: FGXALT

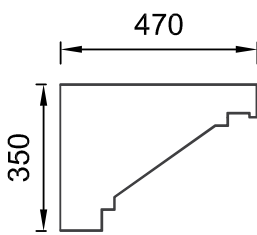

Art.Nr.: FGXALB

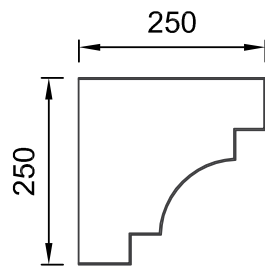

Art.Nr.: FGXALG

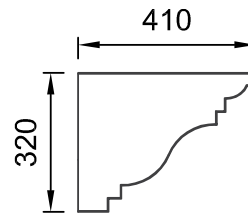

Art.Nr.: FGXALO

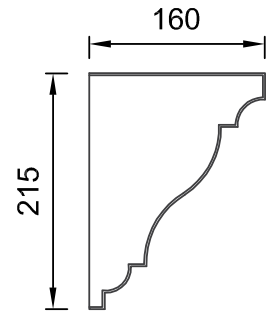

Art.Nr.: FGXALU

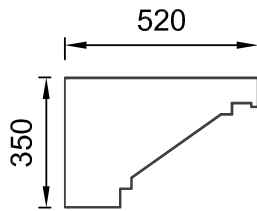

Art.Nr.: FGXALC

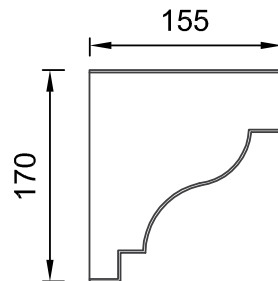

Art.Nr.: FGXALK

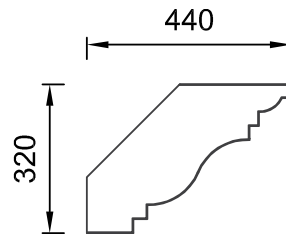

Art.Nr.: FGXALP

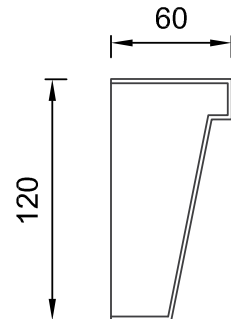

Art.Nr.: FGXALX

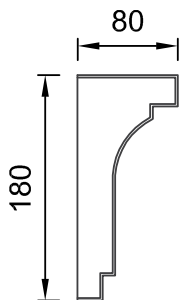

Art.Nr.: FGXALD

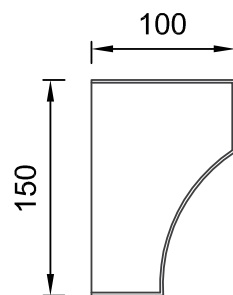

Art.Nr.: FGXALM

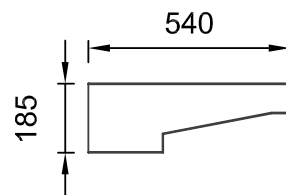

Art.Nr.: FGXALQ

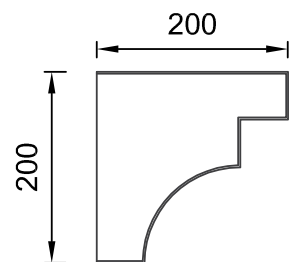

Art.Nr.: FGXALY



QR-Code einfach scannen und
Austrotherm Materiallisten-Generator
online nutzen.

Austrotherm Gesimseprofil

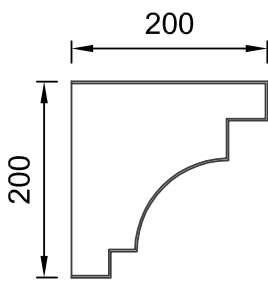

Art.Nr.: FGXALZ

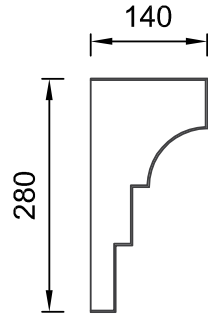

Art.Nr.: FGXAMF

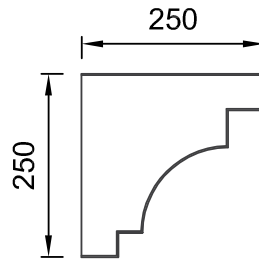

Art.Nr.: FGXAMN

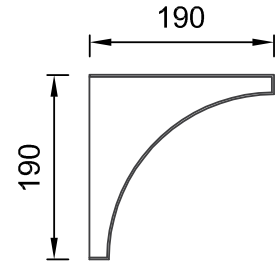

Art.Nr.: FGXAMS

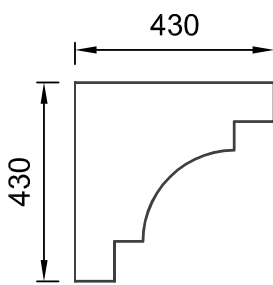

Art.Nr.: FGXAMA

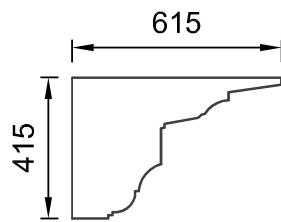

Art.Nr.: FGXAMG

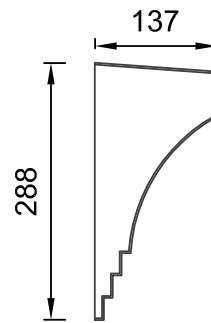

Art.Nr.: FGXAMP

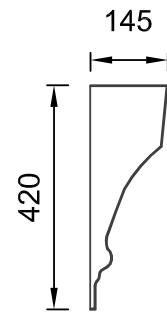

Art.Nr.: FGXAMT

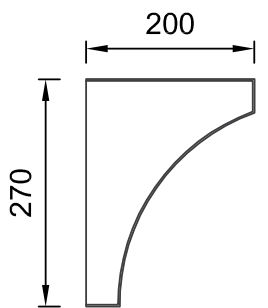

Art.Nr.: FGXAMD

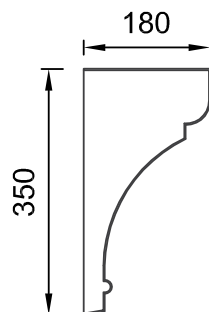

Art.Nr.: FGXAMI

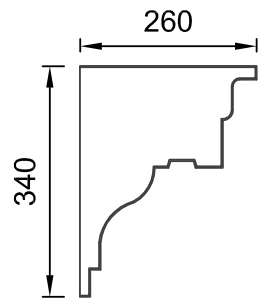

Art.Nr.: FGXAMQ

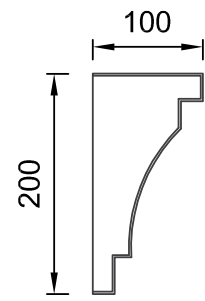

Art.Nr.: FGXAMV

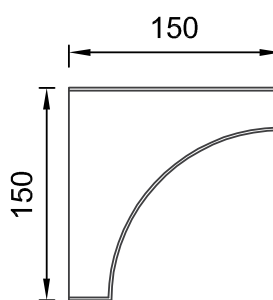

Art.Nr.: FGXAME

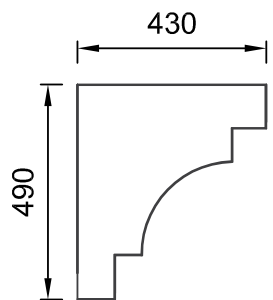

Art.Nr.: FGXAMM

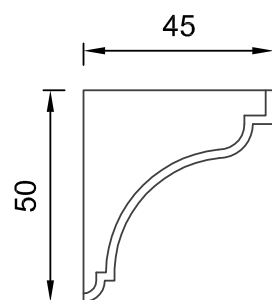

Art.Nr.: FGXAMR

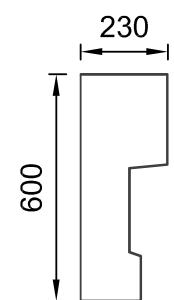

Art.Nr.: FGXAMW



QR-Code einfach scannen und
Austrotherm Materiallisten-Generator
online nutzen.

Austrotherm Gesimseprofil

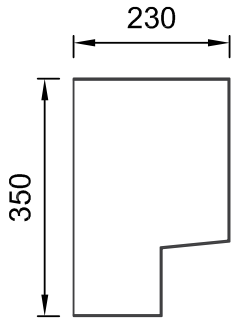

Art.Nr.: FGXAMX

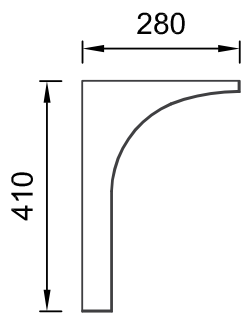

Art.Nr.: FGXANF

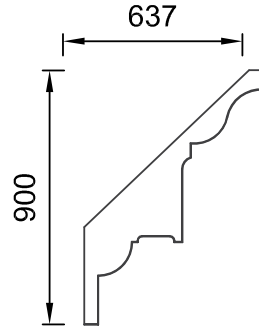

Art.Nr.: FGXANK

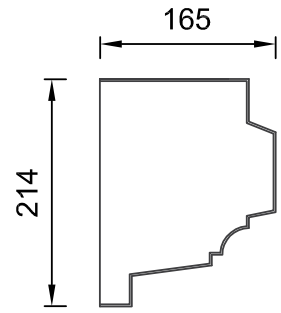

Art.Nr.: FGXANO

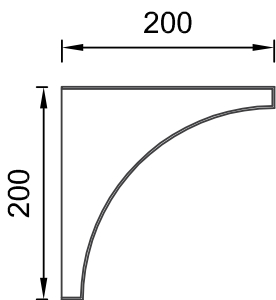

Art.Nr.: FGXAMY

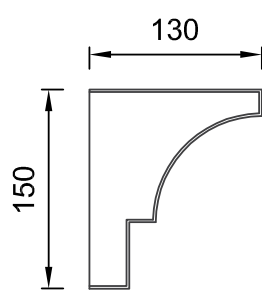

Art.Nr.: FGXANG

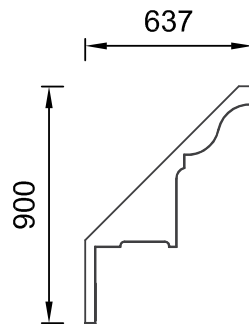

Art.Nr.: FGXANL

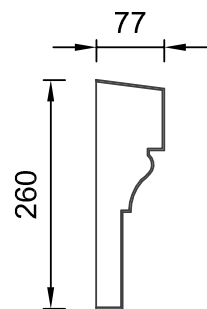

Art.Nr.: FGXANP

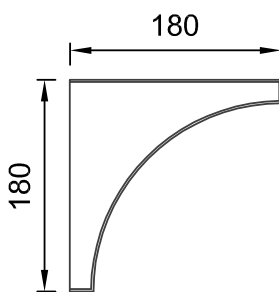

Art.Nr.: FGXAMZ

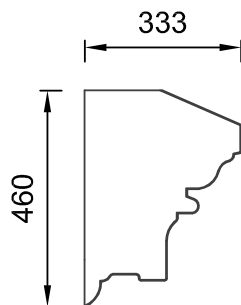

Art.Nr.: FGXANI

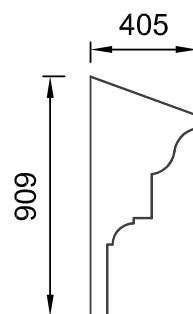

Art.Nr.: FGXANM

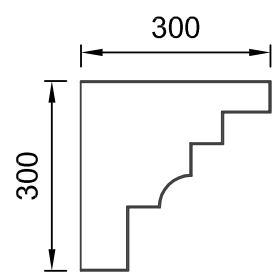

Art.Nr.: FGXANQ

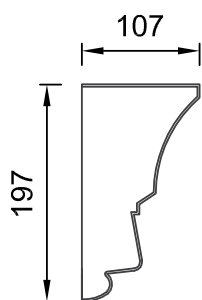

Art.Nr.: FGXANA

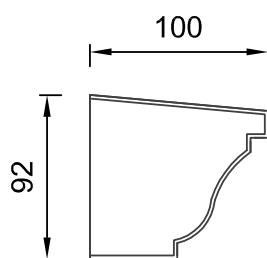

Art.Nr.: FGXANJ

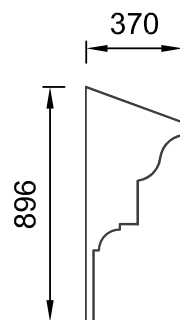

Art.Nr.: FGXANN

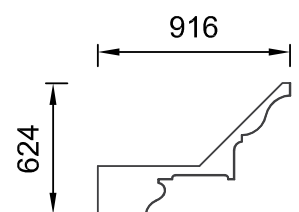

Art.Nr.: FGXANS



QR-Code einfach scannen und
Austrotherm Materiallisten-Generator
online nutzen.

Austrotherm Gesimseprofil

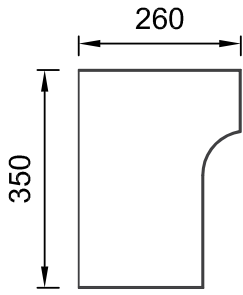

Art.Nr.: FGXANT

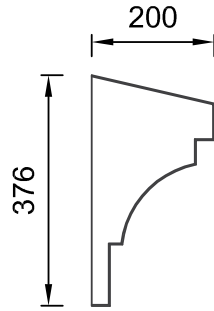

Art.Nr.: FGXAOB

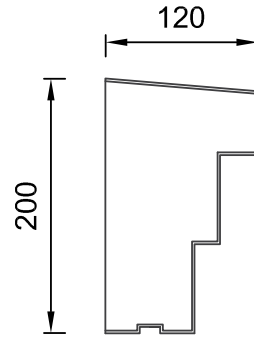

Art.Nr.: FGXAOF

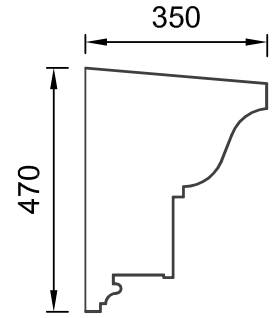

Art.Nr.: FGXAOO

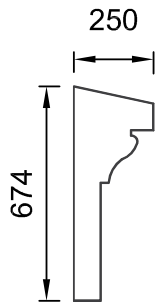

Art.Nr.: FGXANU

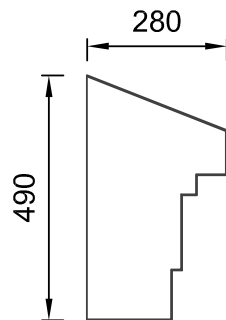

Art.Nr.: FGXAOC

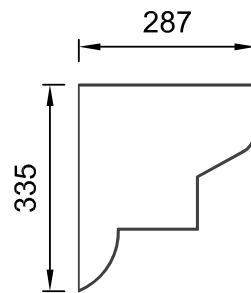

Art.Nr.: FGXAOG

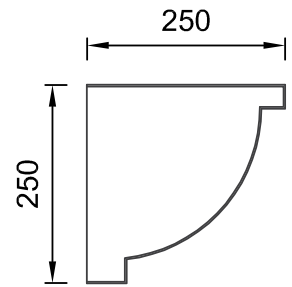

Art.Nr.: FGXAOP

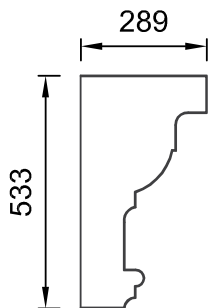

Art.Nr.: FGXANV

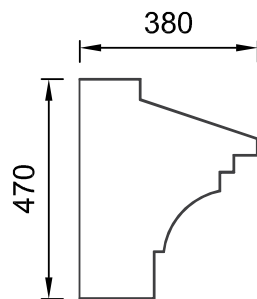

Art.Nr.: FGXAOD

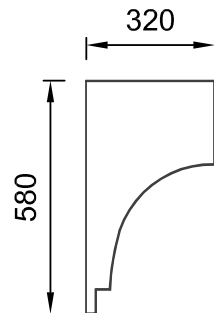

Art.Nr.: FGXAOL

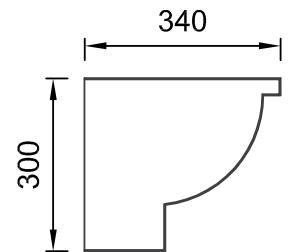

Art.Nr.: FGXAOQ

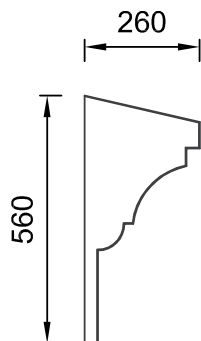

Art.Nr.: FGXANZ

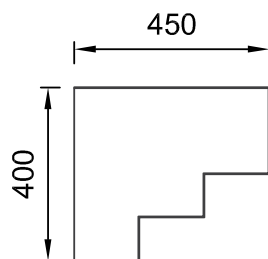

Art.Nr.: FGXAOE

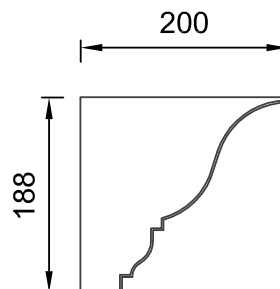

Art.Nr.: FGXAOM

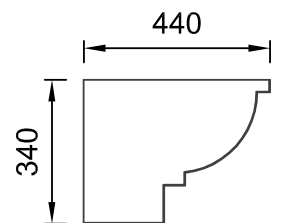

Art.Nr.: FGXAOR



QR-Code einfach scannen und
Austrotherm Materiallisten-Generator
online nutzen.

Austrotherm Gesimseprofil

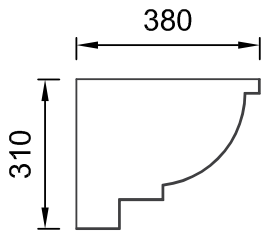

Art.Nr.: FGXAOS

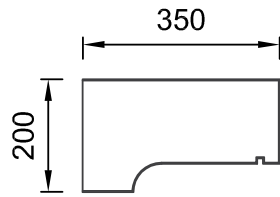

Art.Nr.: FGXAPC

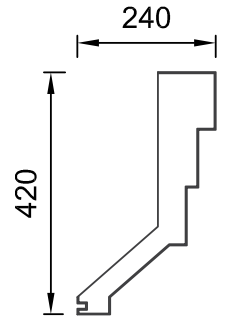

Art.Nr.: FGXAPL

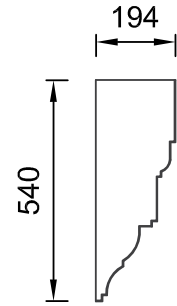

Art.Nr.: FGXAPZ

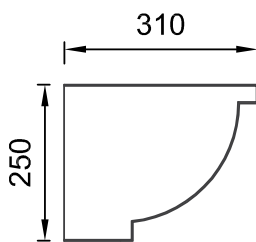

Art.Nr.: FGXAOT

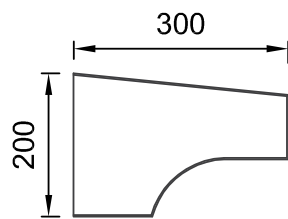

Art.Nr.: FGXAPF

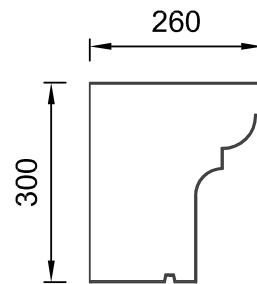

Art.Nr.: FGXAPT

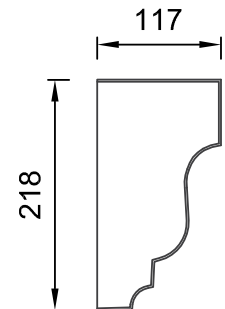

Art.Nr.: FGXAQH

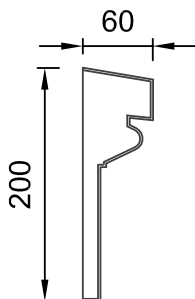

Art.Nr.: FGXAOW

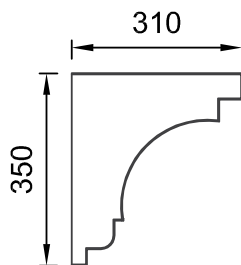

Art.Nr.: FGXAPG

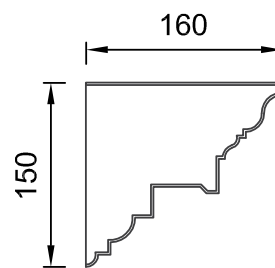

Art.Nr.: FGXAPX

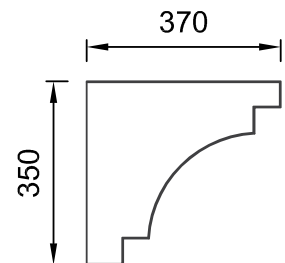

Art.Nr.: FGXAQD

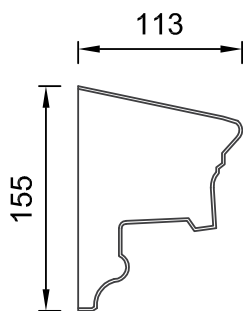

Art.Nr.: FGXAQY

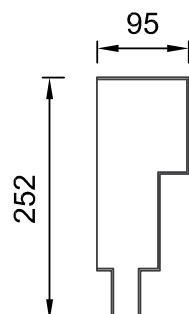

Art.Nr.: FGXAPK

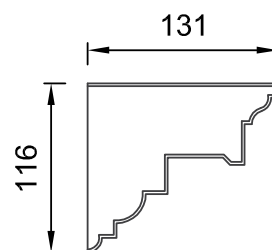

Art.Nr.: FGXAPY

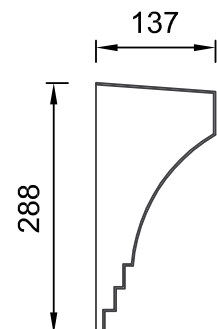

Art.Nr.: FGXAQE



QR-Code einfach scannen und
Austrotherm Materiallisten-Generator
online nutzen.

Austrotherm Gesimseprofil

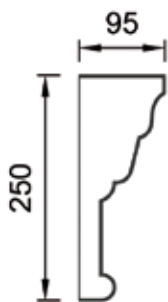

Art.Nr.: FGXAQF



Art.Nr.: FGXAQL



Art.Nr.: FGXAQP



Art.Nr.: FGXAQL

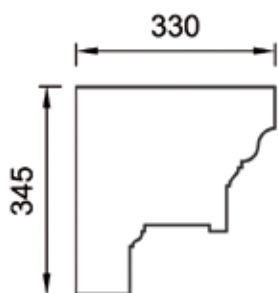

Art.Nr.: FGXAQH

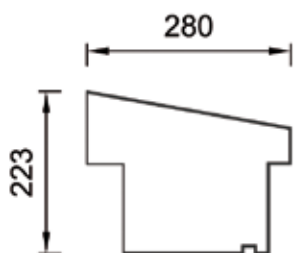

Art.Nr.: FGXAQM

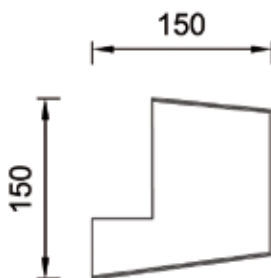

Art.Nr.: FGXAQQ

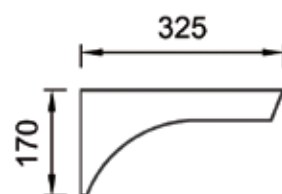

Art.Nr.: FGXAQW

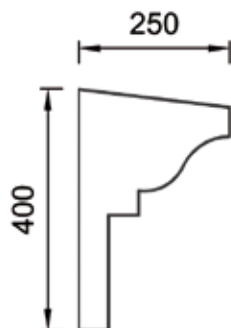

Art.Nr.: FGXAQI

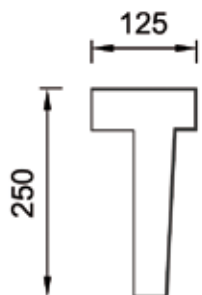

Art.Nr.: FGXAQN

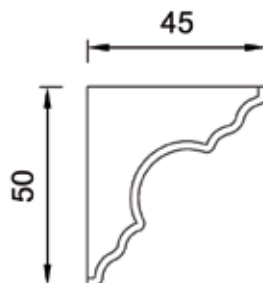

Art.Nr.: FGXAQR

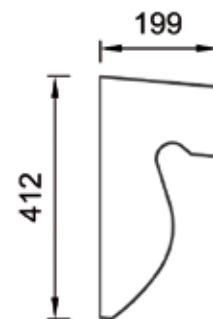

Art.Nr.: FGXAQX

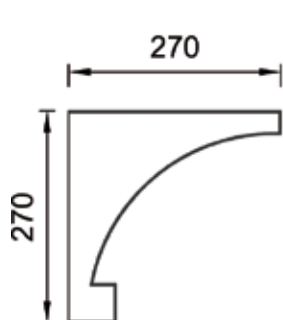

Art.Nr.: FGXAQK

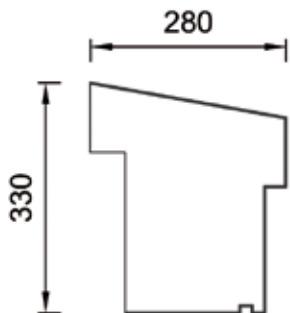

Art.Nr.: FGXAQO

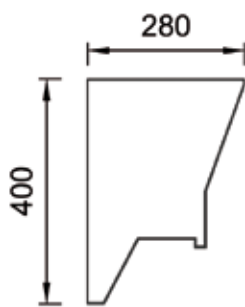

Art.Nr.: FGXAQT

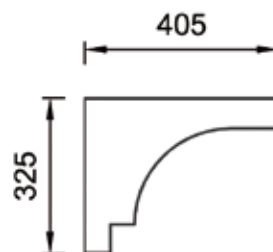

Art.Nr.: FGXAQY



QR-Code einfach scannen und
Austrotherm Materiallisten-Generator
online nutzen.

Austrotherm Gesimseprofil

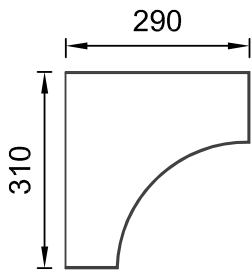

Art.Nr.: FGXAQZ

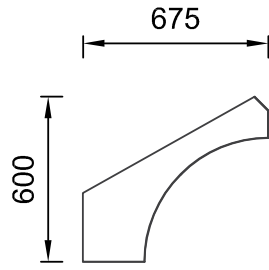

Art.Nr.: FGXARK

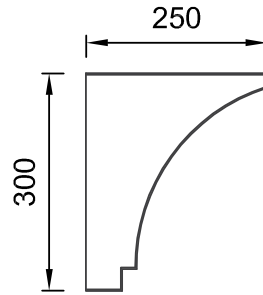

Art.Nr.: FGXASG

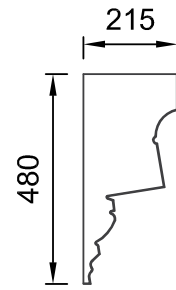

Art.Nr.: FGXASV

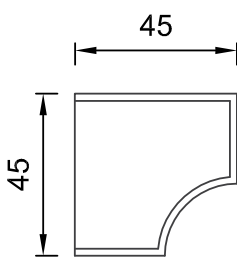

Art.Nr.: FGXARC

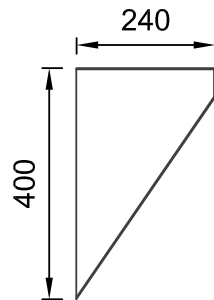

Art.Nr.: FGXARV

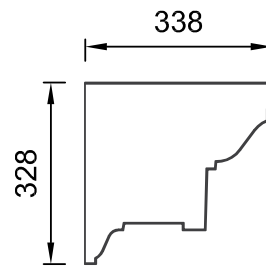

Art.Nr.: FGXASM

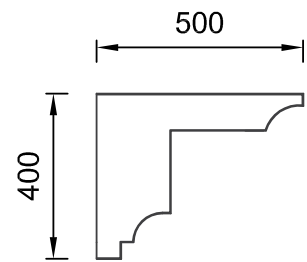

Art.Nr.: FGXATB

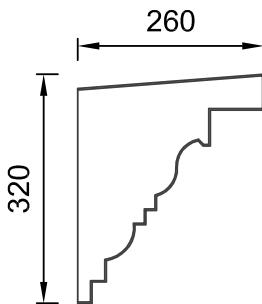

Art.Nr.: FGXARE

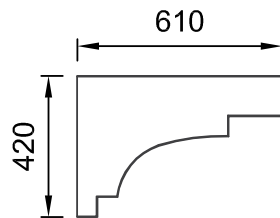

Art.Nr.: FGXASE

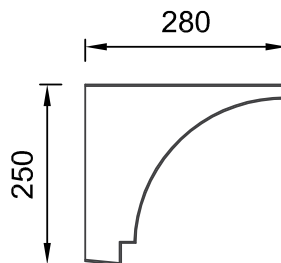

Art.Nr.: FGXASQ

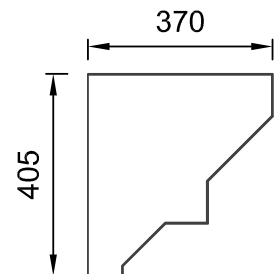

Art.Nr.: FGXATC

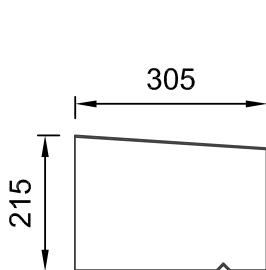

Art.Nr.: FGXARH

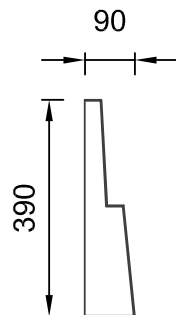

Art.Nr.: FGXASF

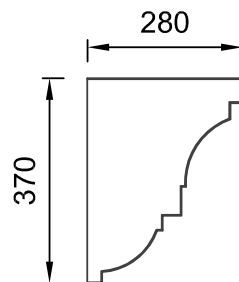

Art.Nr.: FGXAST

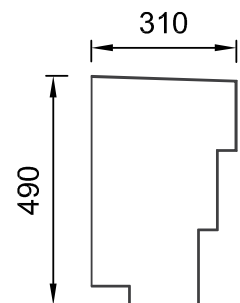

Art.Nr.: FGXATF



QR-Code einfach scannen und
Austrotherm Materiallisten-Generator
online nutzen.

Austrotherm Gesimseprofil

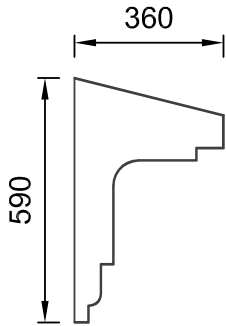

Art.Nr.: FGXATG

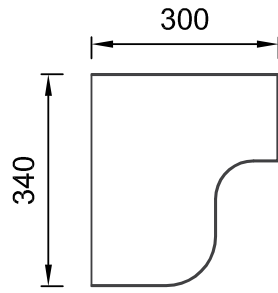

Art.Nr.: FGXATU

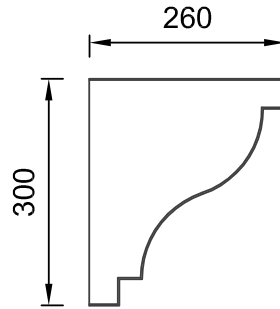

Art.Nr.: FGXATZ

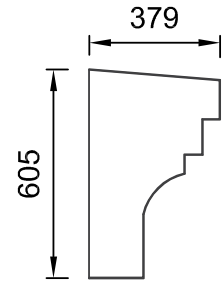

Art.Nr.: FGXAUM

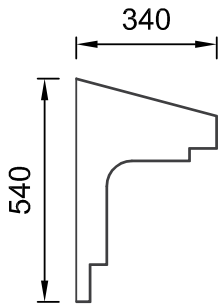

Art.Nr.: FGXATH

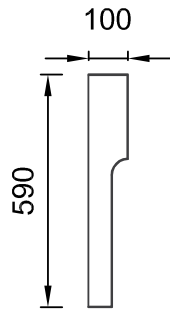

Art.Nr.: FGXATV

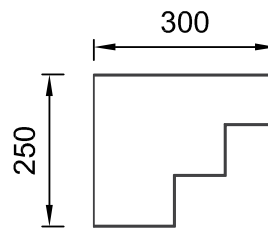

Art.Nr.: FGXAUF

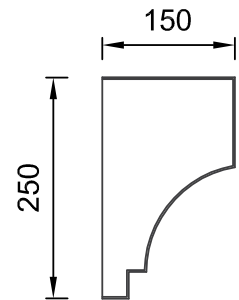

Art.Nr.: FGXAVC

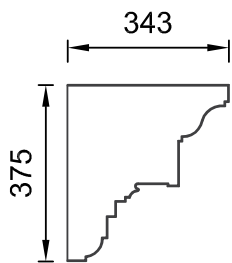

Art.Nr.: FGXATM

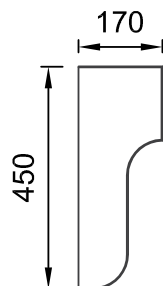

Art.Nr.: FGXATW

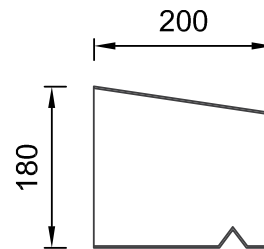

Art.Nr.: FGXAUG

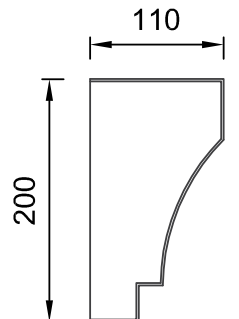

Art.Nr.: FGXAVD

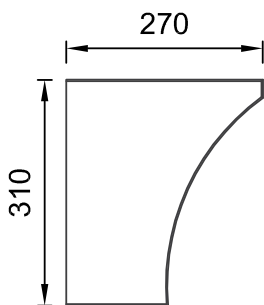

Art.Nr.: FGXATP

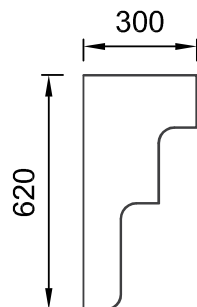

Art.Nr.: FGXATX

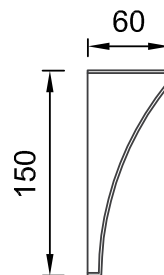

Art.Nr.: FGXAUK

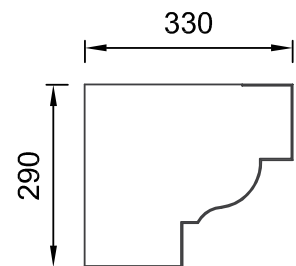

Art.Nr.: FGXAVE



QR-Code einfach scannen und
Austrotherm Materiallisten-Generator
online nutzen.

Austrotherm Gesimseprofil

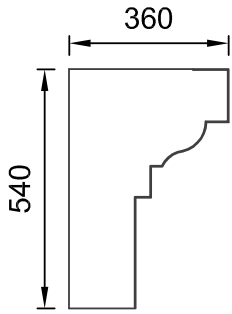

Art.Nr.: FGXAVF

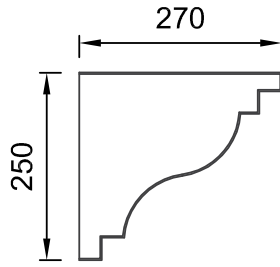

Art.Nr.: FGXAVK

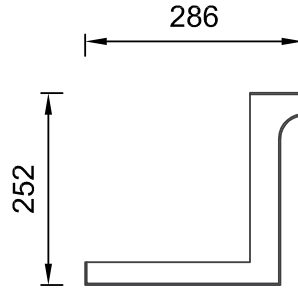

Art.Nr.: FGXAVT

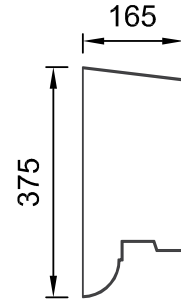

Art.Nr.: FGXAWL

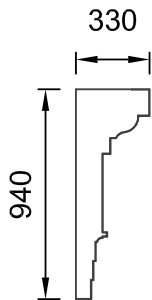

Art.Nr.: FGXAVG

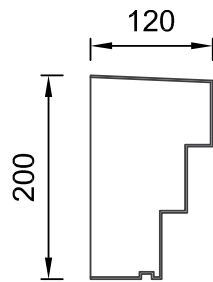

Art.Nr.: FGXAVN

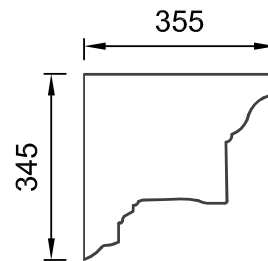

Art.Nr.: FGXAVV

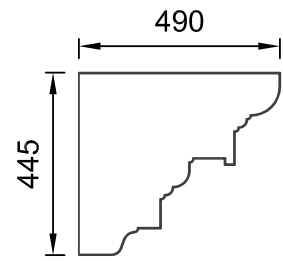

Art.Nr.: FGXAWM

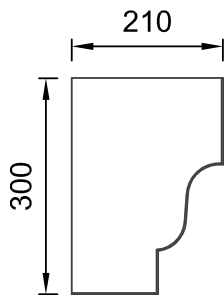

Art.Nr.: FGXAVH

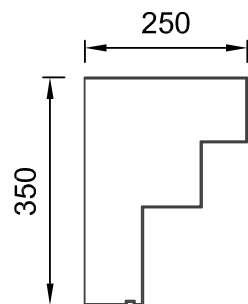

Art.Nr.: FGXAVO

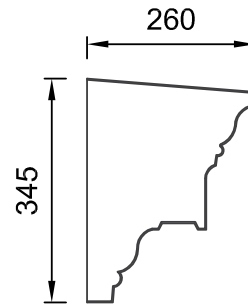

Art.Nr.: FGXAWA

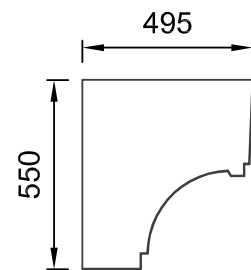

Art.Nr.: FGXAWN

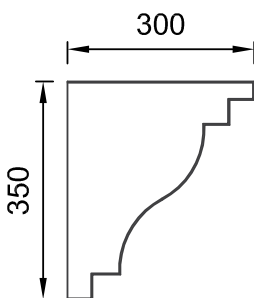

Art.Nr.: FGXAVJ

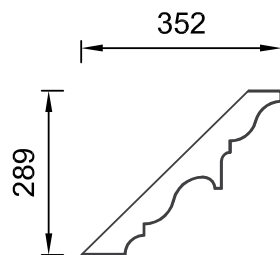

Art.Nr.: FGXAVQ

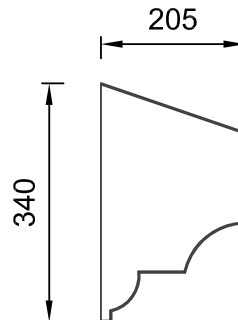

Art.Nr.: FGXAWF

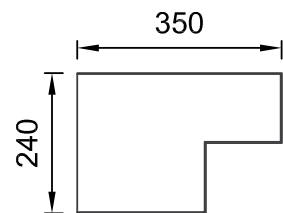

Art.Nr.: FGXAWO



QR-Code einfach scannen und
Austrotherm Materiallisten-Generator
online nutzen.

Austrotherm Gesimseprofil

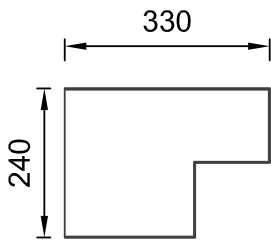

Art.Nr.: FGXAWP

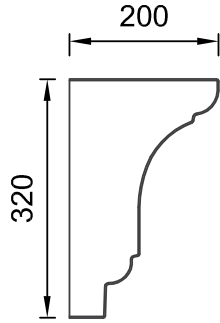

Art.Nr.: FGXAWU

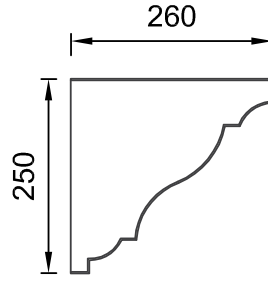

Art.Nr.: FGXAXB

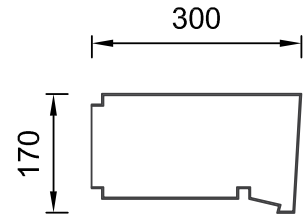

Art.Nr.: FGXAXR

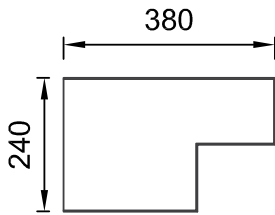

Art.Nr.: FGXAWQ

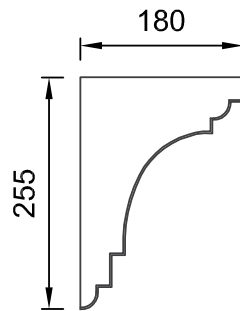

Art.Nr.: FGXAWV

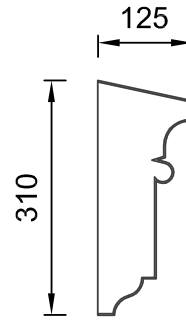

Art.Nr.: FGXAXC

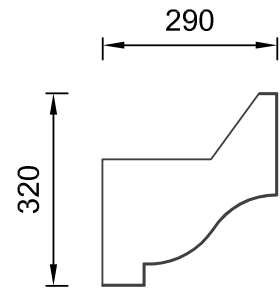

Art.Nr.: FGXAXS

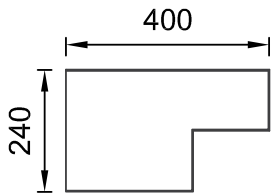

Art.Nr.: FGXAWR

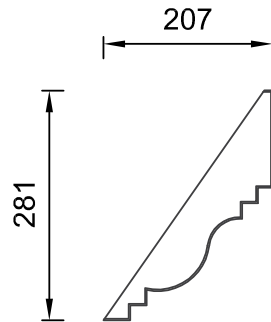

Art.Nr.: FGXAWW

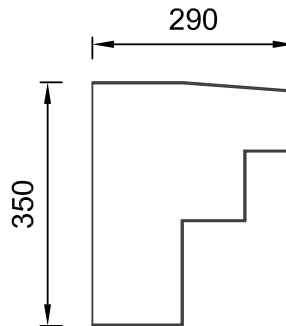

Art.Nr.: FGXAXO

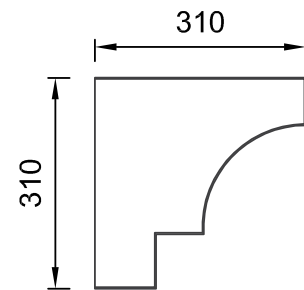

Art.Nr.: FGXAXU

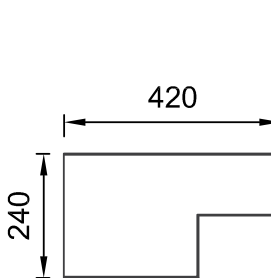

Art.Nr.: FGXAWS

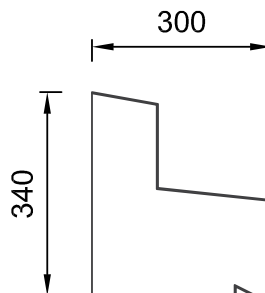

Art.Nr.: FGXAXA

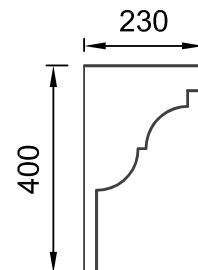

Art.Nr.: FGXAXP

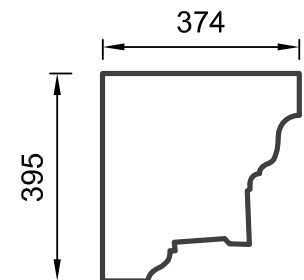

Art.Nr.: FGXAXY



QR-Code einfach scannen und
Austrotherm Materialisten-Generator
online nutzen.

Austrotherm Gesimseprofil

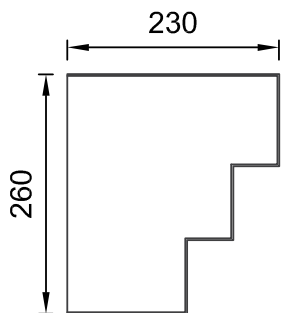

Art.Nr.: FGXAXZ

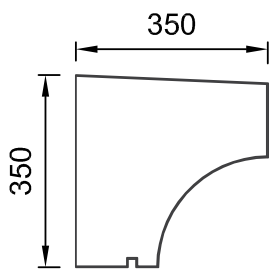

Art.Nr.: FGXAYD

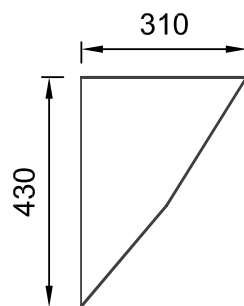

Art.Nr.: FGXAYI

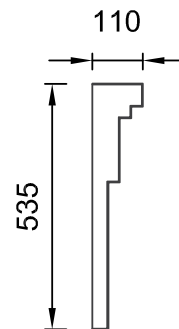

Art.Nr.: FGXAYZ

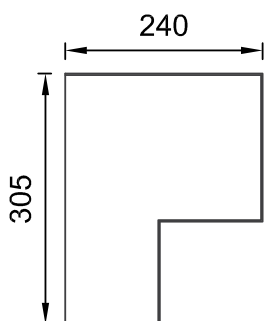

Art.Nr.: FGXAYA

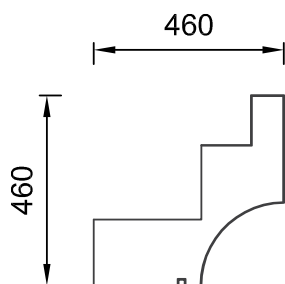

Art.Nr.: FGXAYE

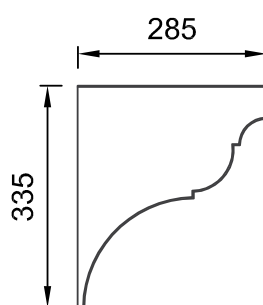

Art.Nr.: FGXAYP

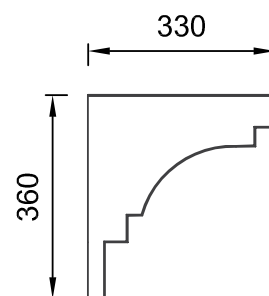

Art.Nr.: FGXAZG

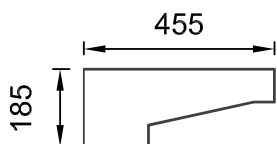

Art.Nr.: FGXAYB

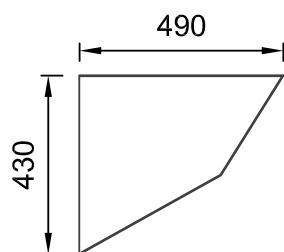

Art.Nr.: FGXAYG

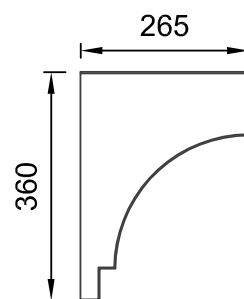

Art.Nr.: FGXAYT

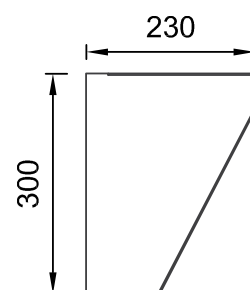

Art.Nr.: FGXAZI

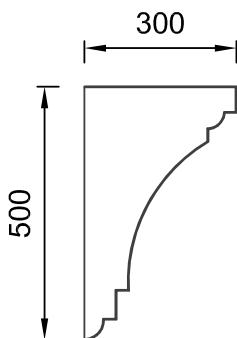

Art.Nr.: FGXAYC

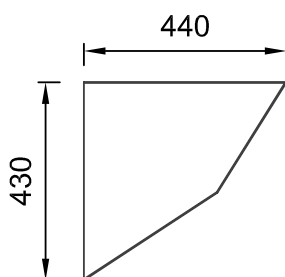

Art.Nr.: FGXAYH

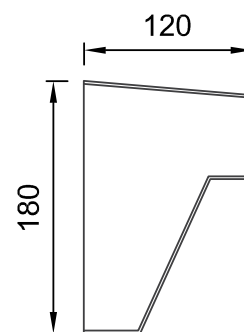

Art.Nr.: FGXAYW

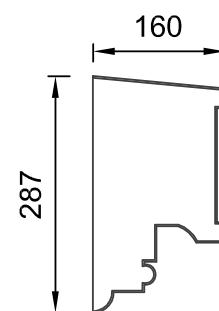

Art.Nr.: FGXAZL



QR-Code einfach scannen und
Austrotherm Materiallisten-Generator
online nutzen.

Austrotherm Gesimseprofil

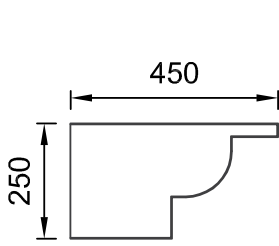

Art.Nr.: FGXA ZS

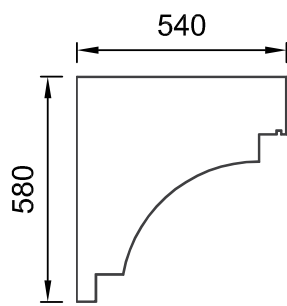

Art.Nr.: FGXA ZW

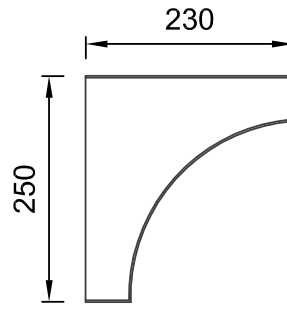

Art.Nr.: FGXBAD

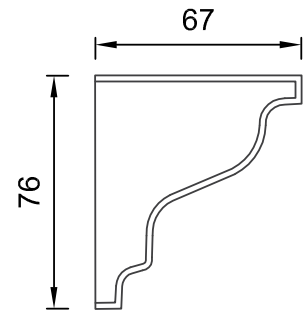

Art.Nr.: FGXBAK

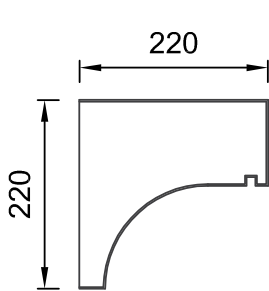

Art.Nr.: FGXA ZT

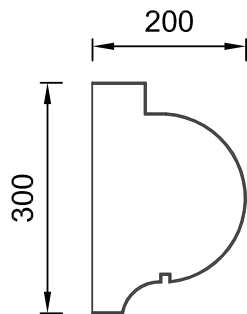

Art.Nr.: FGXA ZX

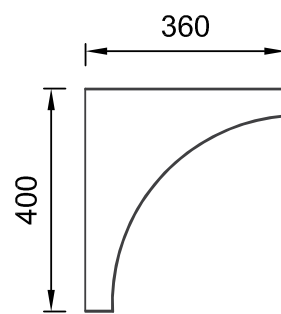

Art.Nr.: FGXB AF

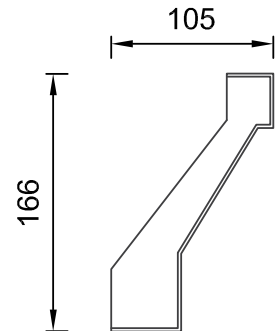

Art.Nr.: FGXB AL

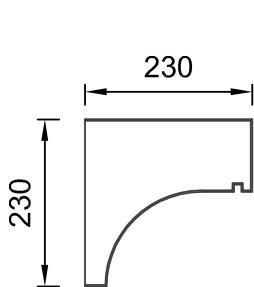

Art.Nr.: FGXA ZU

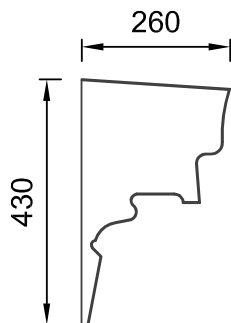

Art.Nr.: FGXA ZZ

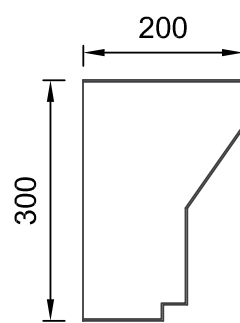

Art.Nr.: FGXB AH

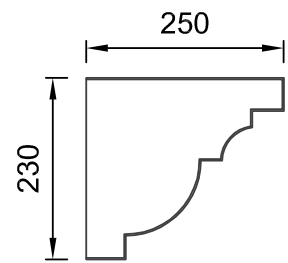

Art.Nr.: FGXB AM

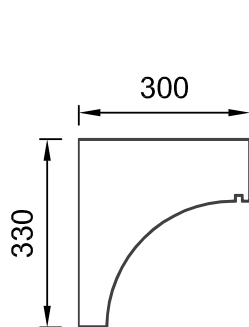

Art.Nr.: FGXA ZV

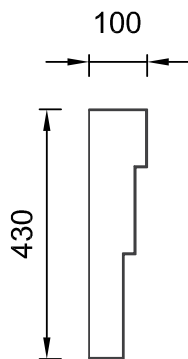

Art.Nr.: FGXB AA

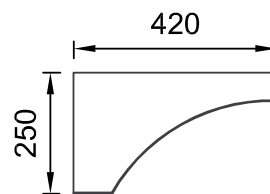

Art.Nr.: FGXB AI

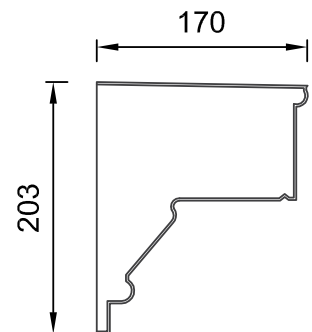

Art.Nr.: FGXB AN



QR-Code einfach scannen und
Austrotherm Materialisten-Generator
online nutzen.

Austrotherm Gesimseprofil

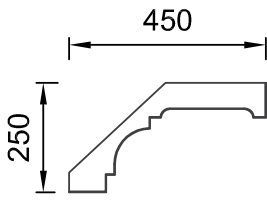

Art.Nr.: FGXBAO

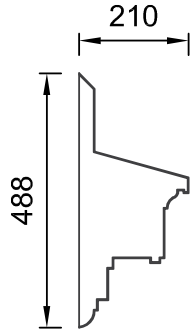

Art.Nr.: FGXBAV

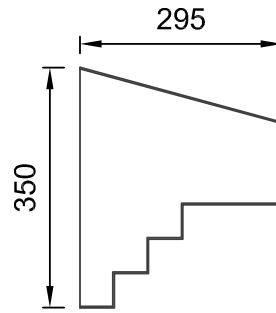

Art.Nr.: FGXBBK

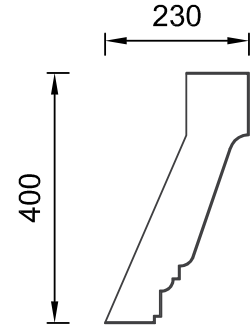

Art.Nr.: FGXBBZ

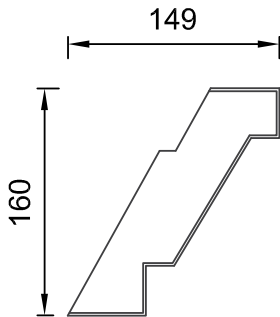

Art.Nr.: FGXBAP

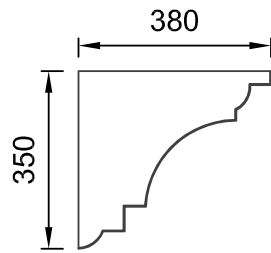

Art.Nr.: FGXBAY

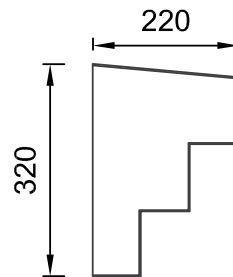

Art.Nr.: FGXBBM

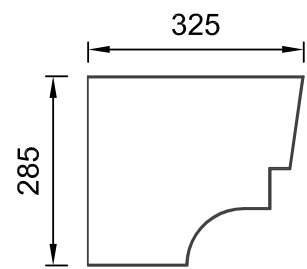

Art.Nr.: FGXBCM

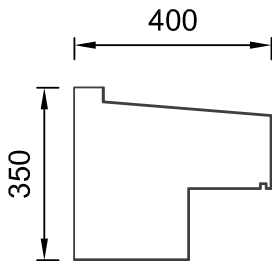

Art.Nr.: FGXBAQ

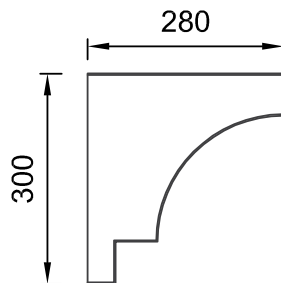

Art.Nr.: FGXBBE

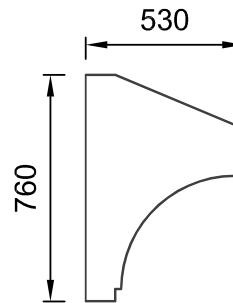

Art.Nr.: FGXBBQ

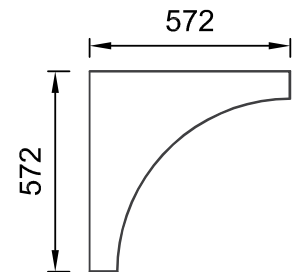

Art.Nr.: FGXBCQ

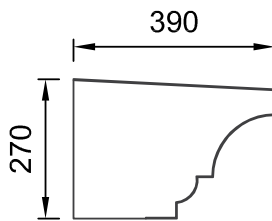

Art.Nr.: FGXBAS

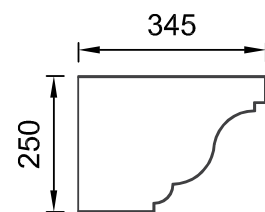

Art.Nr.: FGXBBF

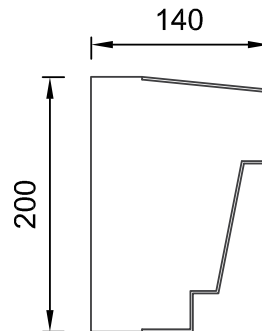

Art.Nr.: FGXBBV

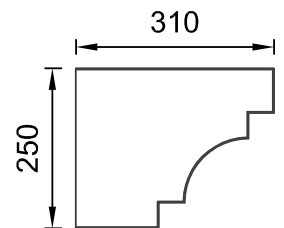

Art.Nr.: FGXBCR



QR-Code einfach scannen und
Austrotherm Materiallisten-Generator
online nutzen.

Austrotherm Gesimseprofil

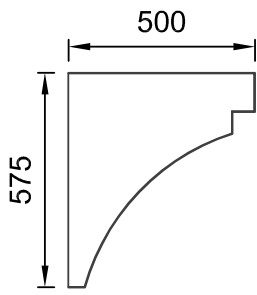

Art.Nr.: FGXBCX

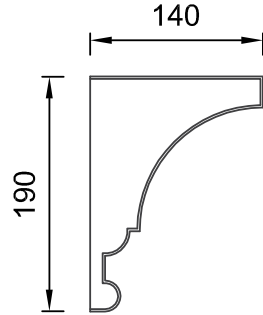

Art.Nr.: FGXBDJ

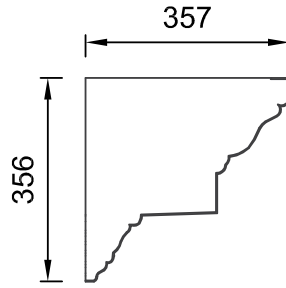

Art.Nr.: FGXBEC

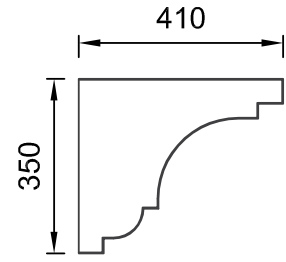

Art.Nr.: FGXBEV

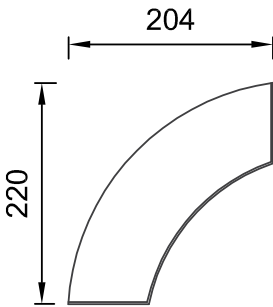

Art.Nr.: FGXBCZ

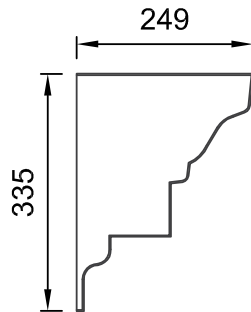

Art.Nr.: FGXBDL

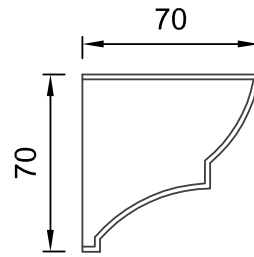

Art.Nr.: FGXBEE

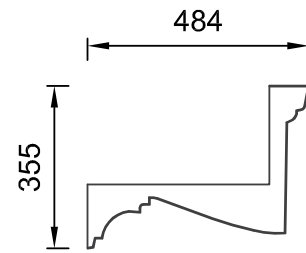

Art.Nr.: FGXBFF

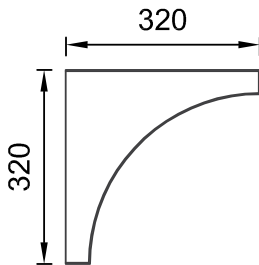

Art.Nr.: FGXBDA

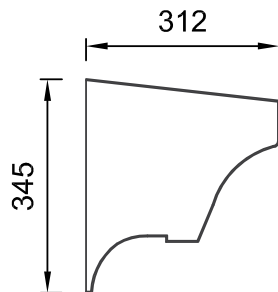

Art.Nr.: FGXBDU

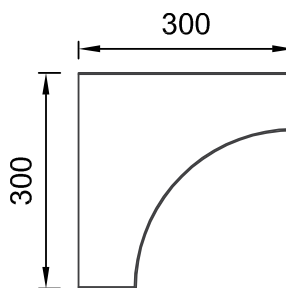

Art.Nr.: FGXBEI

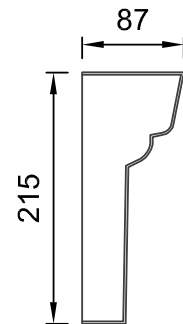

Art.Nr.: FGXBFG

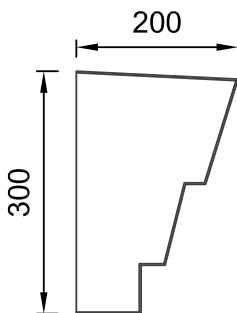

Art.Nr.: FGXBDF

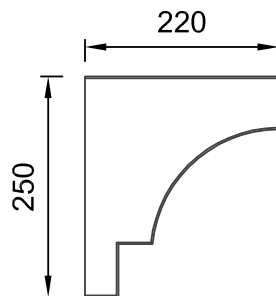

Art.Nr.: FGXB DV

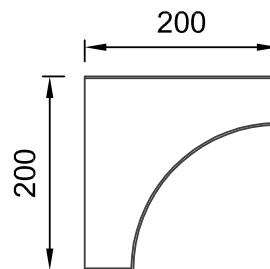

Art.Nr.: FGXBES

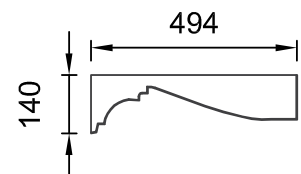

Art.Nr.: FGXB FH



QR-Code einfach scannen und
Austrotherm Materiallisten-Generator
online nutzen.

Austrotherm Gesimseprofil

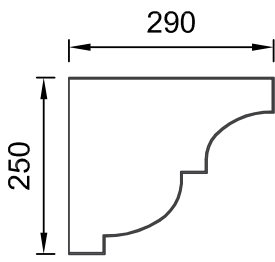

Art.Nr.: FGXBFI

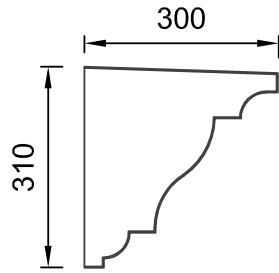

Art.Nr.: FGXBFT

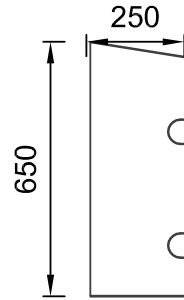

Art.Nr.: FGXBFY

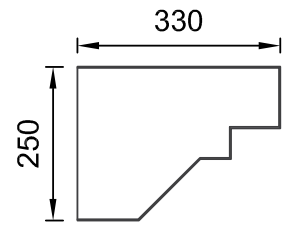

Art.Nr.: FGXBGE

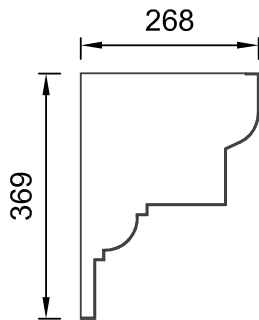

Art.Nr.: FGXBFM

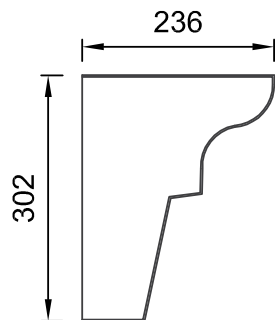

Art.Nr.: FGXBFU

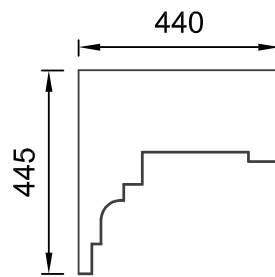

Art.Nr.: FGXBFZ

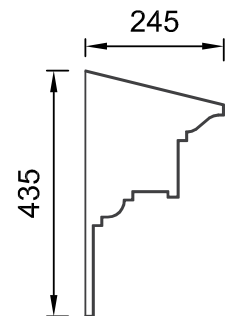

Art.Nr.: FGXBGJ

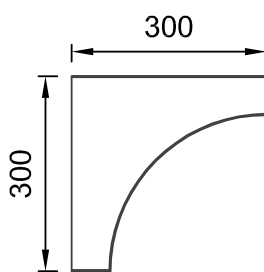

Art.Nr.: FGXBFN

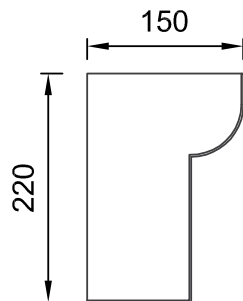

Art.Nr.: FGXBFBV

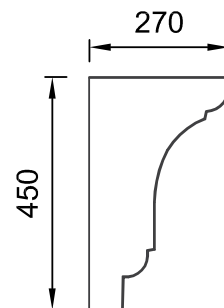

Art.Nr.: FGXBGB

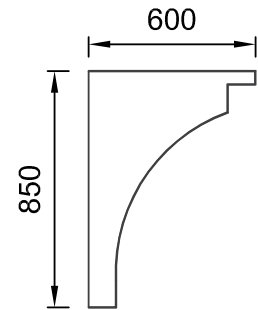

Art.Nr.: FGXBGL

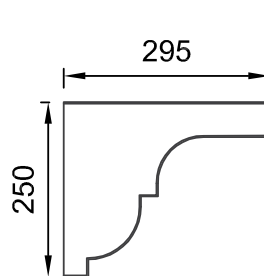

Art.Nr.: FGXBFO

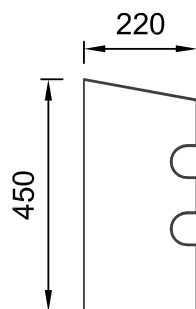

Art.Nr.: FGXBFX

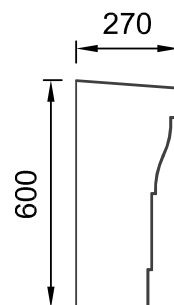

Art.Nr.: FGXBGD

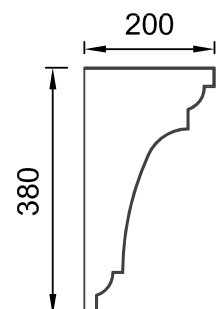

Art.Nr.: FGXBGM



QR-Code einfach scannen und
Austrotherm Materiallisten-Generator
online nutzen.

Austrotherm Gesimseprofil

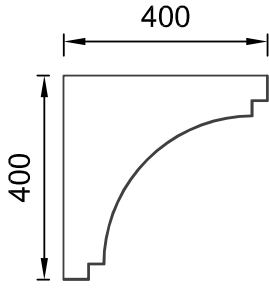

Art.Nr.: FGXBGN

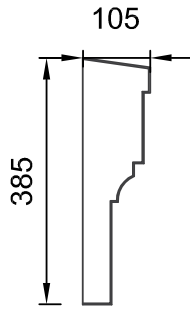

Art.Nr.: FGXBGS

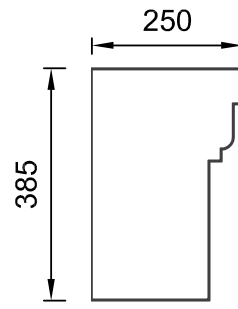

Art.Nr.: FGXBGW

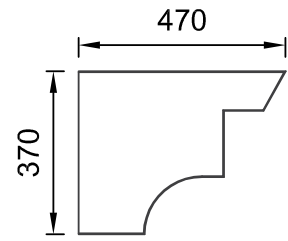

Art.Nr.: FGXBHC

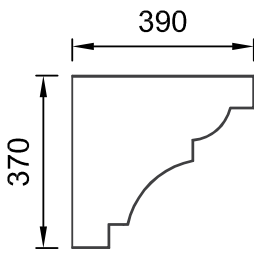

Art.Nr.: FGXBGO

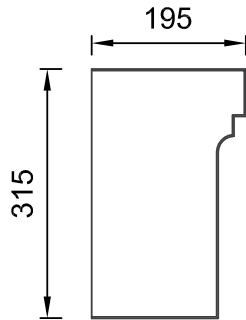

Art.Nr.: FGXBGT

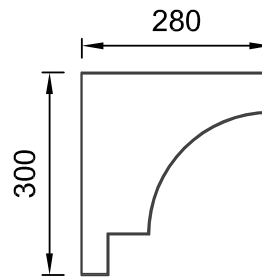

Art.Nr.: FGXBGX

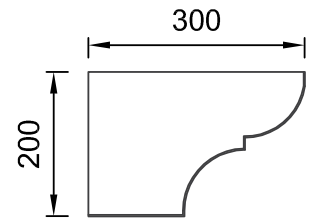

Art.Nr.: FGXBHL

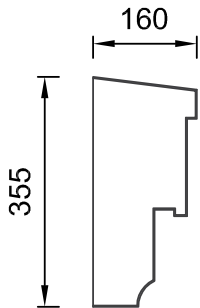

Art.Nr.: FGXBGP

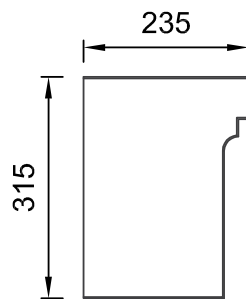

Art.Nr.: FGXBGU

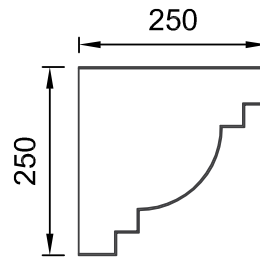

Art.Nr.: FGXBGZ

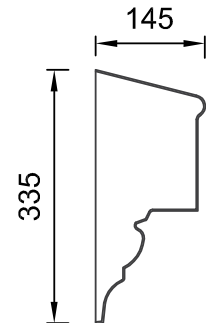

Art.Nr.: FGXBHN

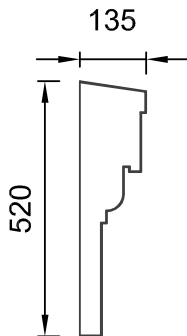

Art.Nr.: FGXBGR

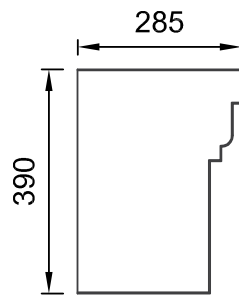

Art.Nr.: FGXBGV

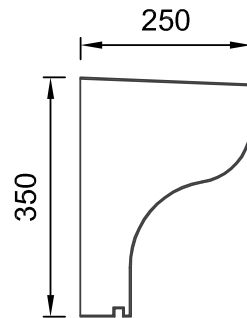

Art.Nr.: FGXBHB

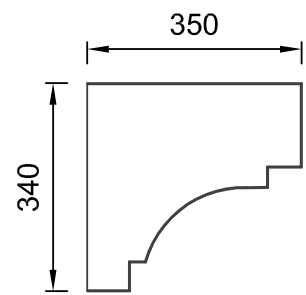

Art.Nr.: FGXBHS



QR-Code einfach scannen und
Austrotherm Materiallisten-Generator
online nutzen.

Austrotherm Gesimseprofil

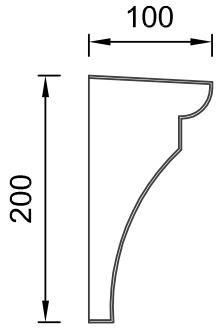

Art.Nr.: FGXBHW

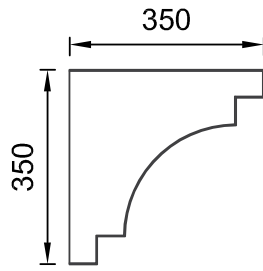

Art.Nr.: FGXBIB

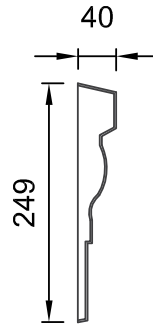

Art.Nr.: FGXBIJ

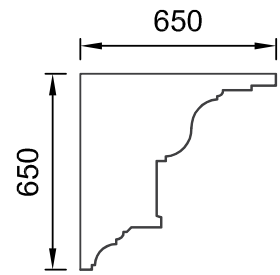

Art.Nr.: FGXBIP

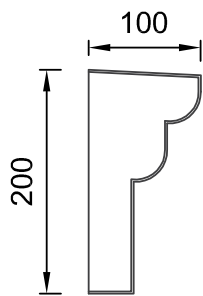

Art.Nr.: FGXBHX

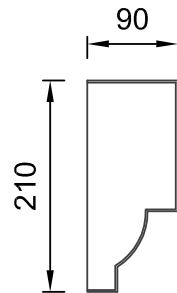

Art.Nr.: FGXBIE

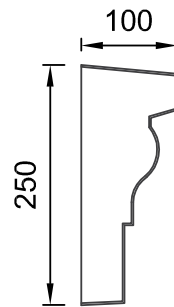

Art.Nr.: FGXBIK

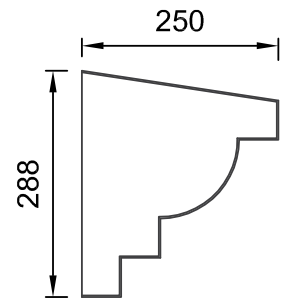

Art.Nr.: FGXBIS

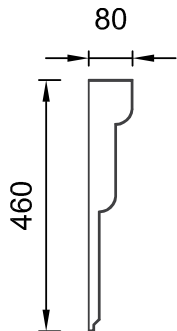

Art.Nr.: FGXBHY

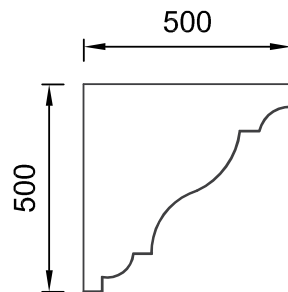

Art.Nr.: FGXBIH

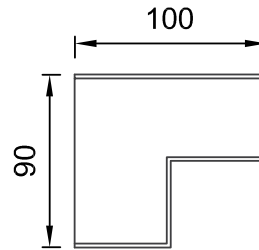

Art.Nr.: FGXBIL

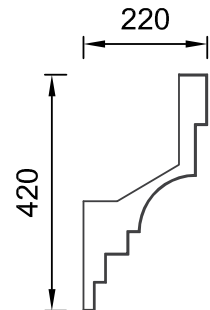

Art.Nr.: FGXBIT

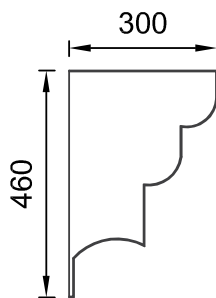

Art.Nr.: FGXBHZ

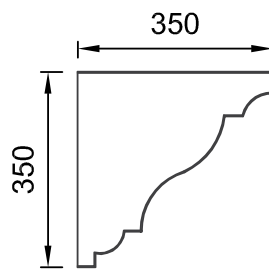

Art.Nr.: FGXBII

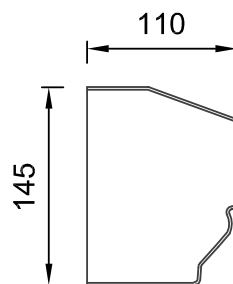

Art.Nr.: FGXBIM

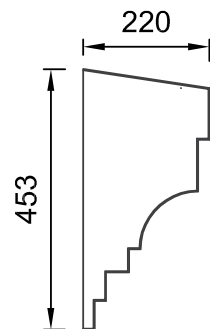

Art.Nr.: FGXBIU



QR-Code einfach scannen und
Austrotherm Materiallisten-Generator
online nutzen.

Austrotherm Gesimseprofil

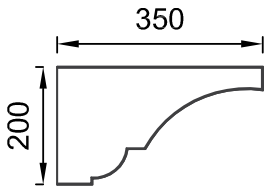

Art.Nr.: FGXBIW

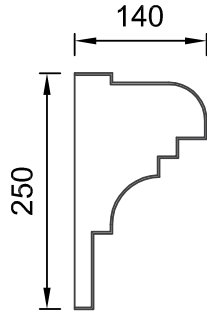

Art.Nr.: FGXBJE

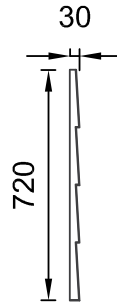

Art.Nr.: FGXBJJ

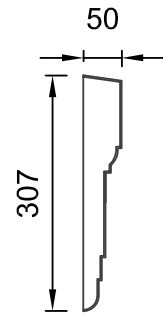

Art.Nr.: FGXBJU

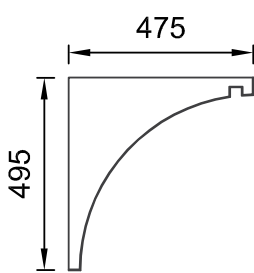

Art.Nr.: FGXBIX

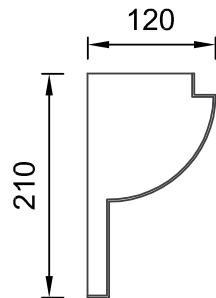

Art.Nr.: FGXBJF

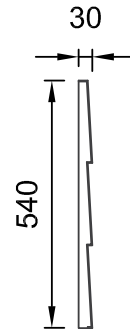

Art.Nr.: FGXBJK

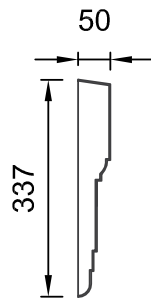

Art.Nr.: FGXBJV

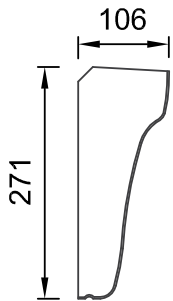

Art.Nr.: FGXBJB

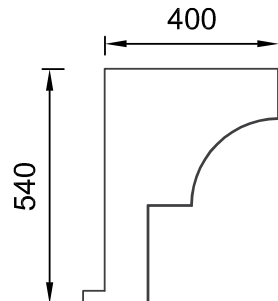

Art.Nr.: FGXBJH

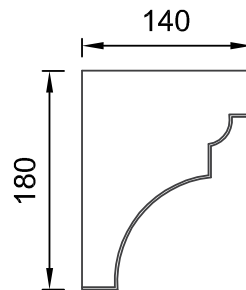

Art.Nr.: FGXBJL

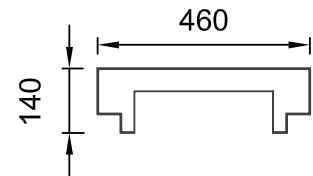

Art.Nr.: FGXBJX

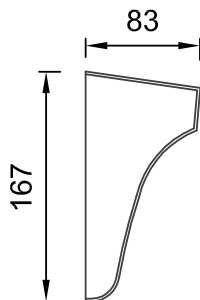

Art.Nr.: FGXBJC

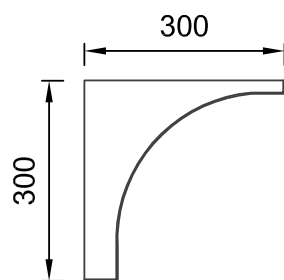

Art.Nr.: FGXBJI

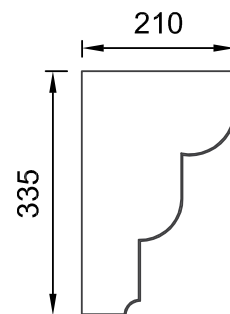

Art.Nr.: FGXBJS

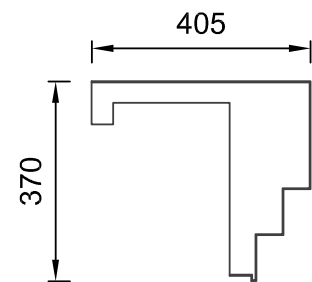

Art.Nr.: FGXBJZ



QR-Code einfach scannen und
Austrotherm Materiallisten-Generator
online nutzen.

Austrotherm Gesimseprofil

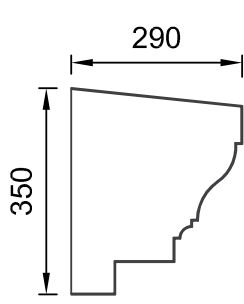

Art.Nr.: FGXBKA

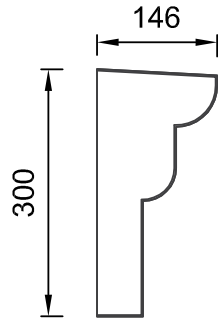

Art.Nr.: FGXBKP

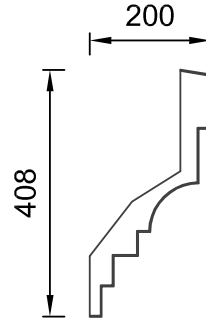

Art.Nr.: FGXBKV

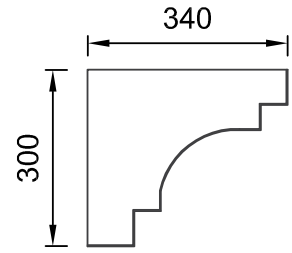

Art.Nr.: FGXBLH

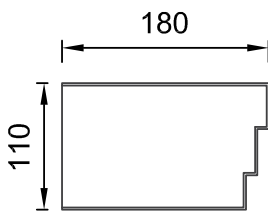

Art.Nr.: FGXBKC

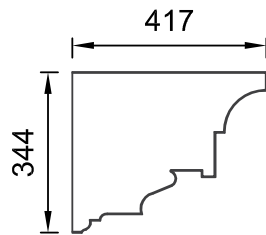

Art.Nr.: FGXBKQ

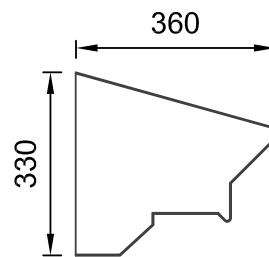

Art.Nr.: FGXBKZ

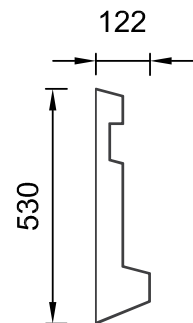

Art.Nr.: FGXBLI

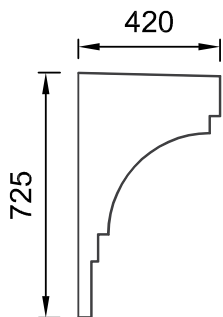

Art.Nr.: FGXBKK

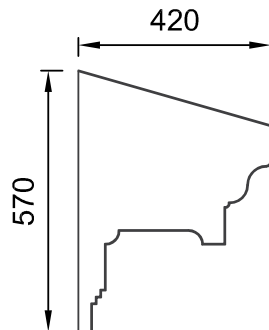

Art.Nr.: FGXBKR

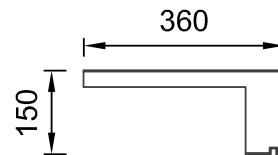

Art.Nr.: FGXBLB

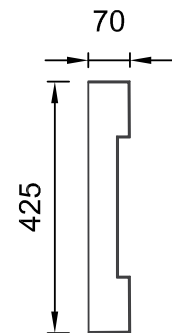

Art.Nr.: FGXBLJ

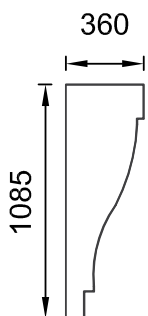

Art.Nr.: FGXBKL

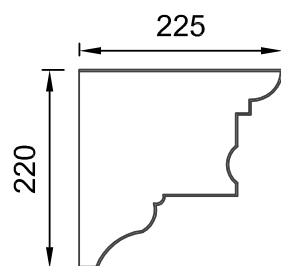

Art.Nr.: FGXBKT

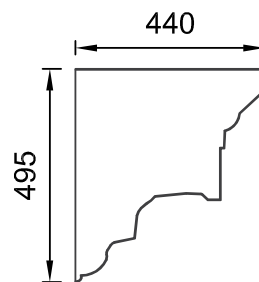

Art.Nr.: FGXBLG

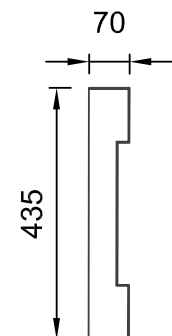

Art.Nr.: FGXBLK



QR-Code einfach scannen und
Austrotherm Materiallisten-Generator
online nutzen.

Austrotherm Gesimseprofil

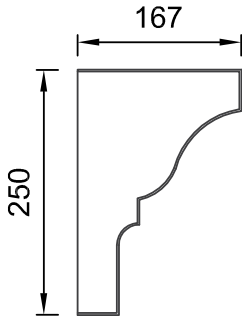

Art.Nr.: FGXBLL

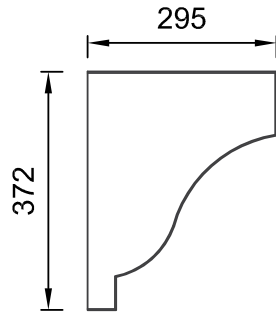

Art.Nr.: FGXBLP

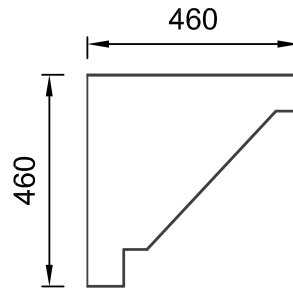

Art.Nr.: FGXBLU

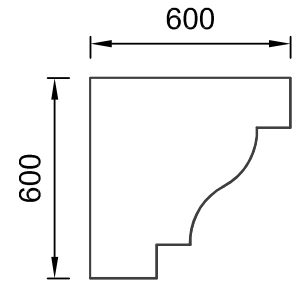

Art.Nr.: FGXBME

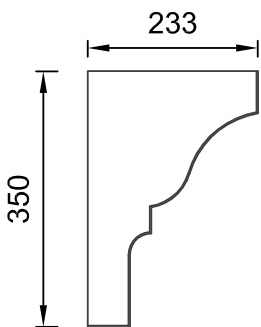

Art.Nr.: FGXBLLM

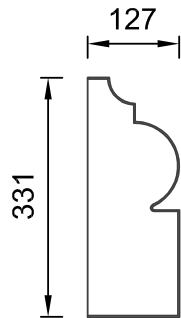

Art.Nr.: FGXBLR

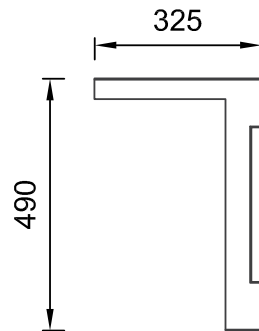

Art.Nr.: FGXBLV

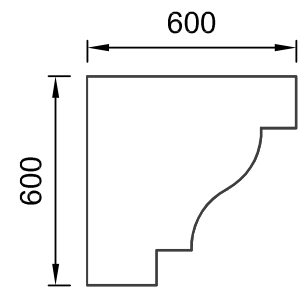

Art.Nr.: FGXBMF

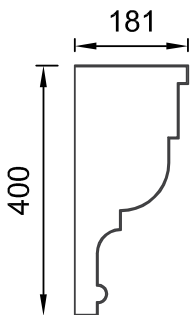

Art.Nr.: FGXBLLN

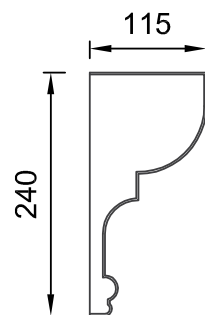

Art.Nr.: FGXBLLS

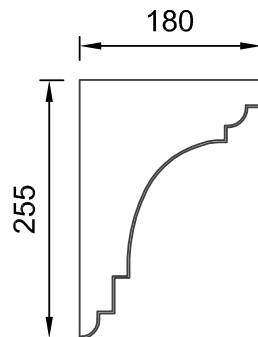

Art.Nr.: FGXAUV

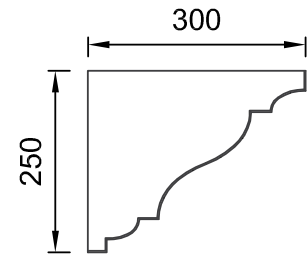

Art.Nr.: FGXBMG

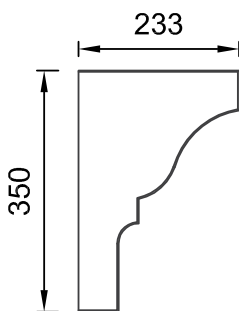

Art.Nr.: FGXBLO

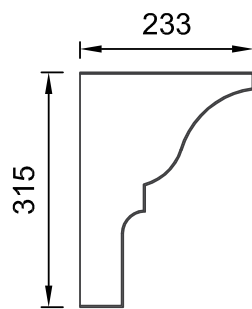

Art.Nr.: FGXBLOT

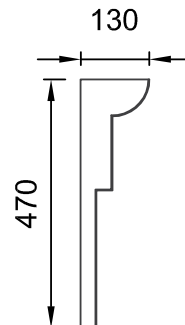

Art.Nr.: FGXBLLZ

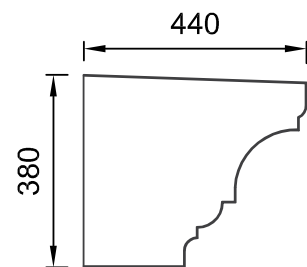

Art.Nr.: FGXBMH



QR-Code einfach scannen und
Austrotherm Materiallisten-Generator
online nutzen.

Austrotherm Gesimseprofil

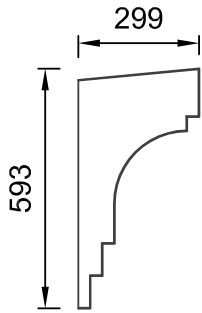

Art.Nr.: FGXBMI

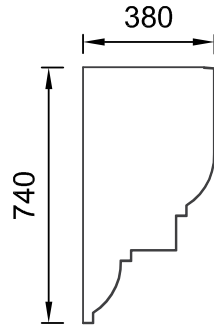

Art.Nr.: FGXBMN

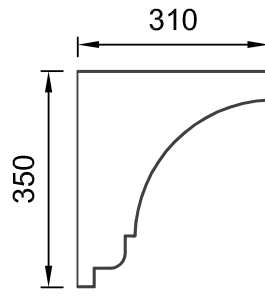

Art.Nr.: FGXBMZ

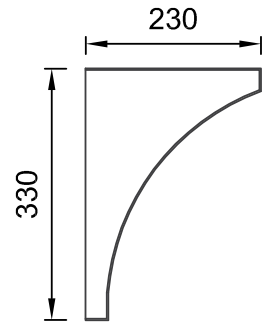

Art.Nr.: FGXBNF

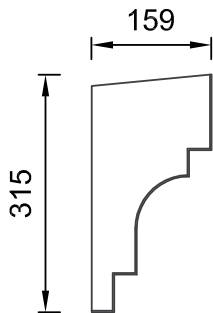

Art.Nr.: FGXBMJ

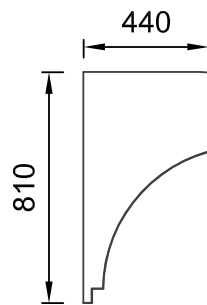

Art.Nr.: FGXBMC

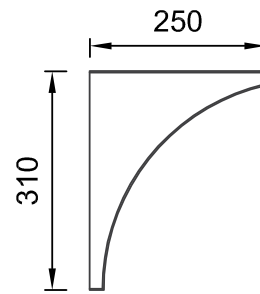

Art.Nr.: FGXBNB

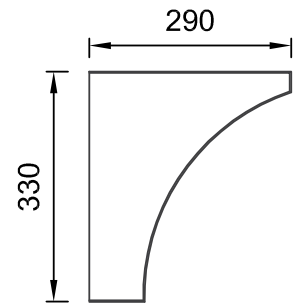

Art.Nr.: FGXBNG

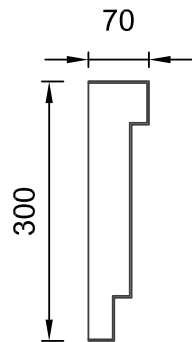

Art.Nr.: FGXBMK

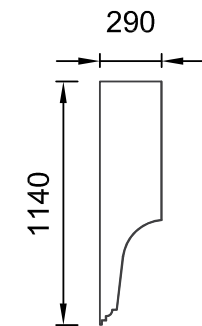

Art.Nr.: FGXBMP

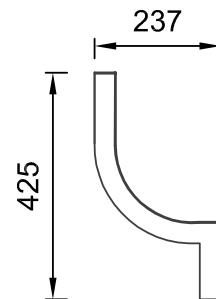

Art.Nr.: FGXBNC

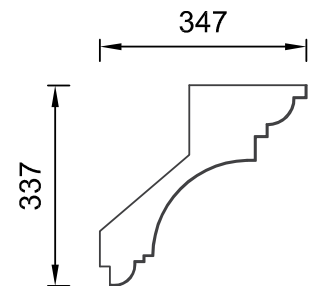

Art.Nr.: FGXBNI

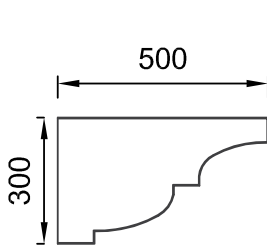

Art.Nr.: FGXBML

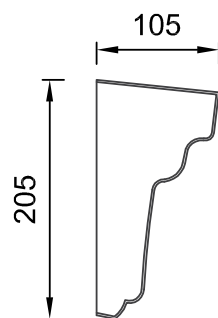

Art.Nr.: FGXBMS

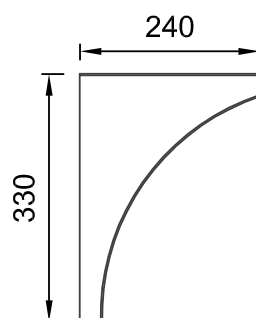

Art.Nr.: FGXBND

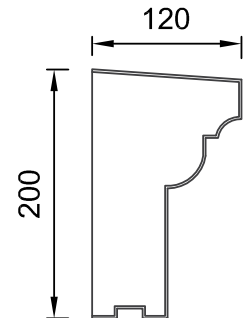

Art.Nr.: FGXBNM



QR-Code einfach scannen und
Austrotherm Materiallisten-Generator
online nutzen.

Austrotherm Gesimseprofil

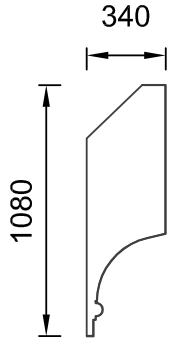

Art.Nr.: FGXBNO

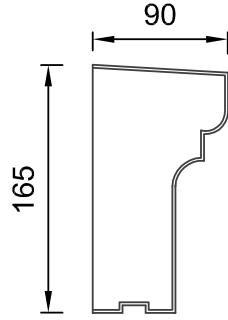

Art.Nr.: FGXBNV

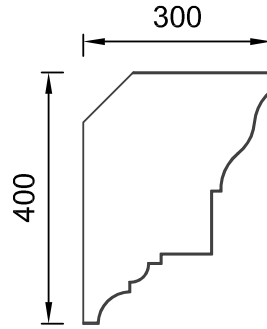

Art.Nr.: FGXBOC

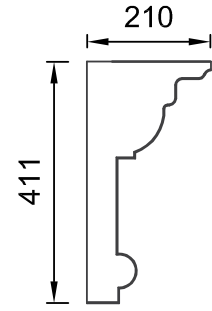

Art.Nr.: FGXBOQ

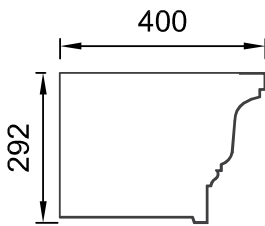

Art.Nr.: FGXBNP

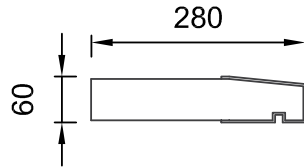

Art.Nr.: FGXBNX

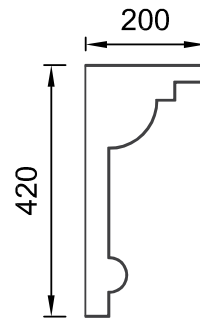

Art.Nr.: FGXBOD

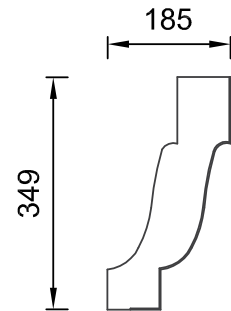

Art.Nr.: FGXBOR

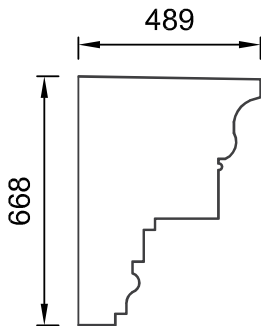

Art.Nr.: FGXBNQ

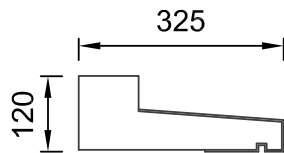

Art.Nr.: FGXBNY

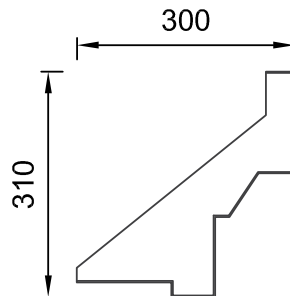

Art.Nr.: FGXBOE

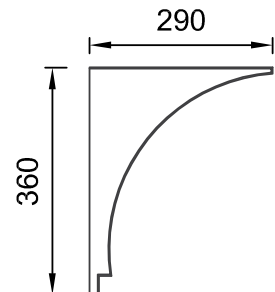

Art.Nr.: FGXBOV

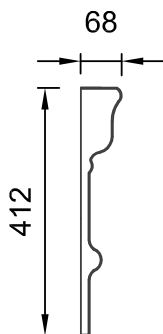

Art.Nr.: FGXBNS

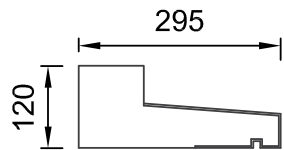

Art.Nr.: FGXBNZ

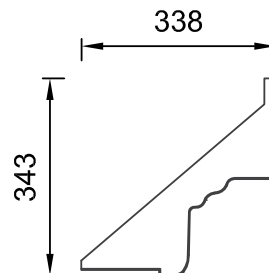

Art.Nr.: FGXBOP

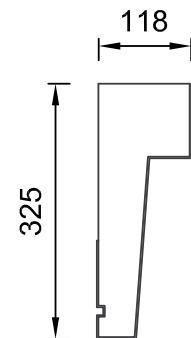

Art.Nr.: FGXBOW



QR-Code einfach scannen und
Austrotherm Materiallisten-Generator
online nutzen.

Austrotherm Gesimseprofil

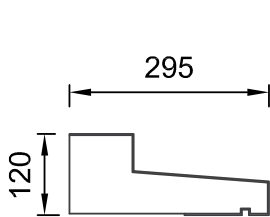

Art.Nr.: FGXBOX

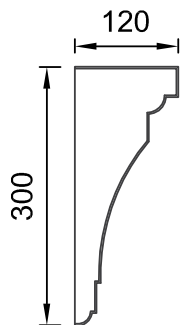

Art.Nr.: FGXBPB

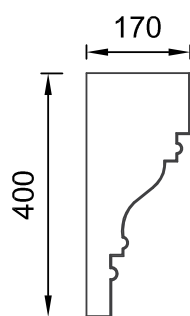

Art.Nr.: FGXBPI

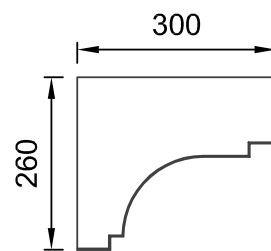

Art.Nr.: FGXBPS

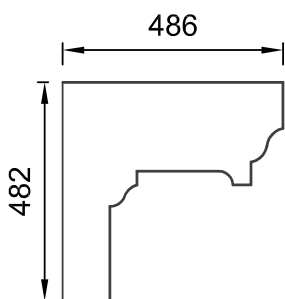

Art.Nr.: FGXBOY

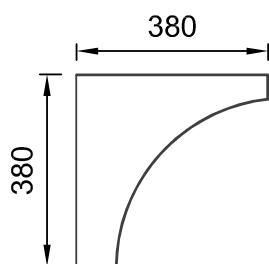

Art.Nr.: FGXBPC

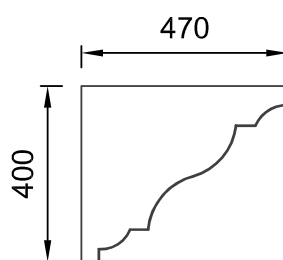

Art.Nr.: FGXBPK

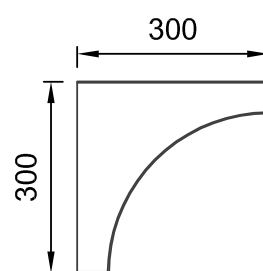

Art.Nr.: FGXBPU

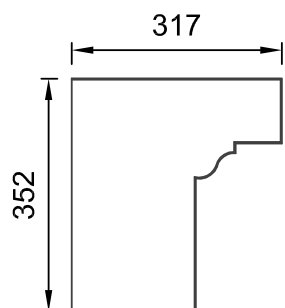

Art.Nr.: FGXBOZ

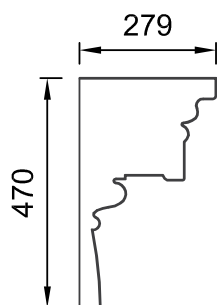

Art.Nr.: FGXBPF

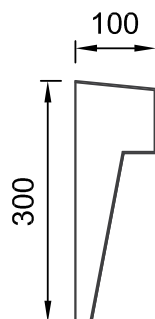

Art.Nr.: FGXBPL

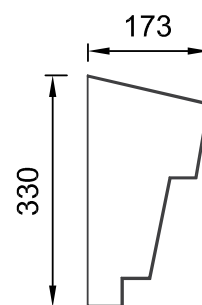

Art.Nr.: FGXBPV

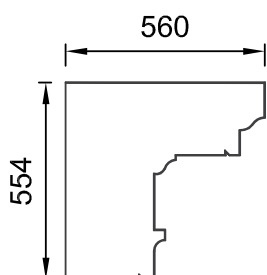

Art.Nr.: FGXBPA

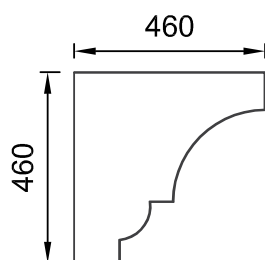

Art.Nr.: FGXBPH

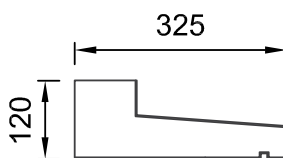

Art.Nr.: FGXBPN

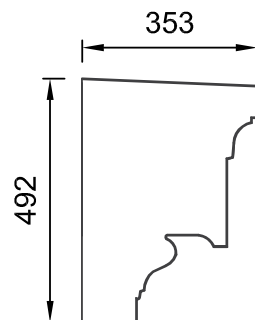

Art.Nr.: FGXBPW



QR-Code einfach scannen und
Austrotherm Materiallisten-Generator
online nutzen.

Austrotherm Gesimseprofil

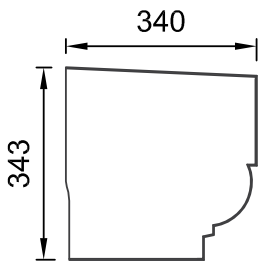

Art.Nr.: FGXBPX

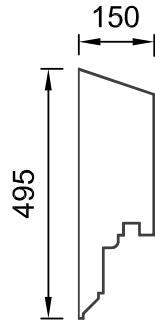

Art.Nr.: FGXBQB

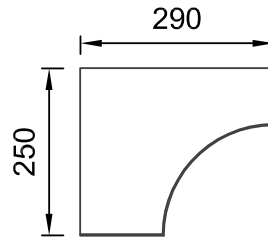

Art.Nr.: FGXBQJ

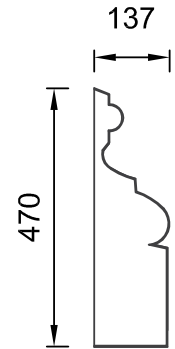

Art.Nr.: FGXBQP

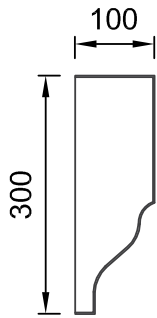

Art.Nr.: FGXBPY

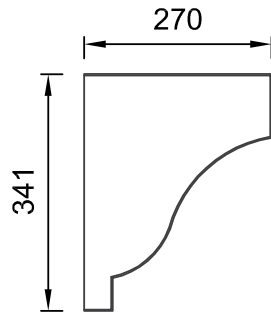

Art.Nr.: FGXBQD

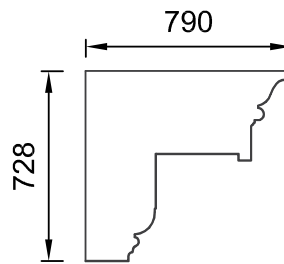

Art.Nr.: FGXBQK

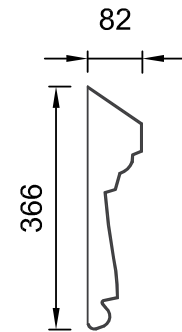

Art.Nr.: FGXBQQ

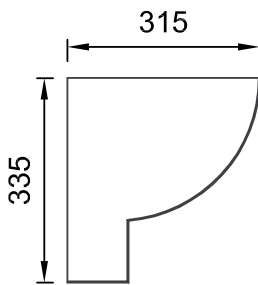

Art.Nr.: FGXBPZ

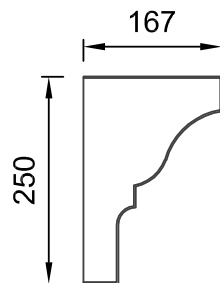

Art.Nr.: FGXBQE

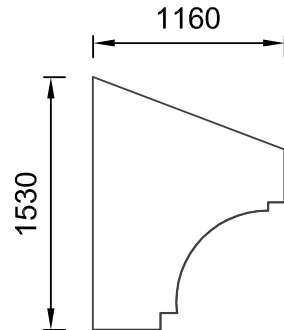

Art.Nr.: FGXBQL

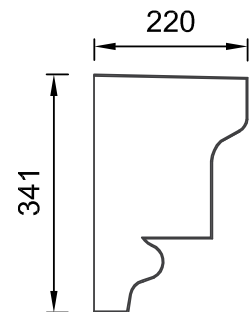

Art.Nr.: FGXBQR

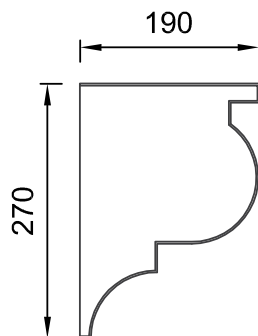

Art.Nr.: FGXBQA

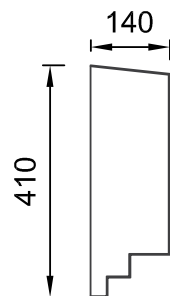

Art.Nr.: FGXBQH

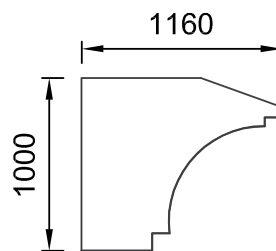

Art.Nr.: FGXBQN

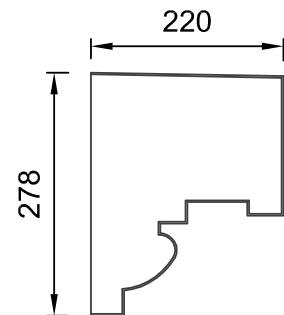

Art.Nr.: FGXBQS



QR-Code einfach scannen und
Austrotherm Materiallisten-Generator
online nutzen.

Austrotherm Gesimseprofil

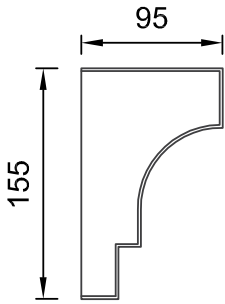

Art.Nr.: FGXBQT

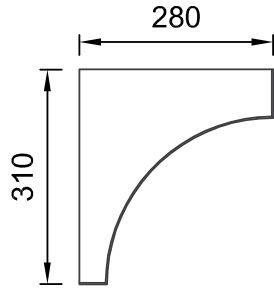

Art.Nr.: FGXBQZ

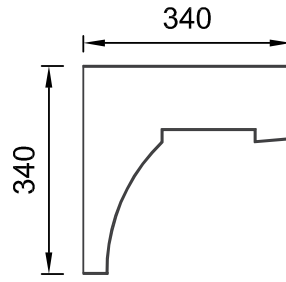

Art.Nr.: FGXBRE

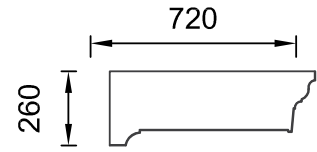

Art.Nr.: FGXBRI

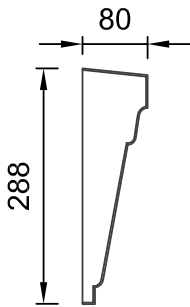

Art.Nr.: FGXBQW

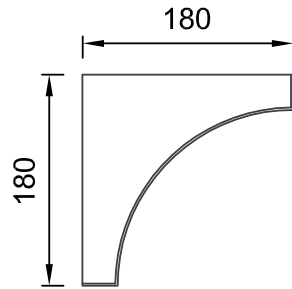

Art.Nr.: FGXBRA

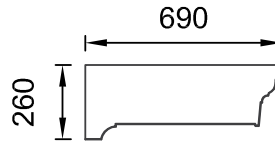

Art.Nr.: FGXBRF

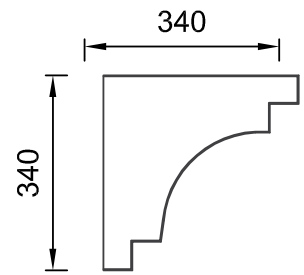

Art.Nr.: FGXBRK

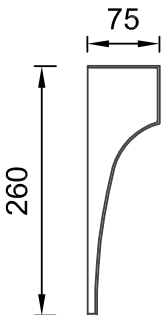

Art.Nr.: FGXBQX

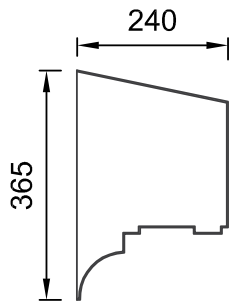

Art.Nr.: FGXBRB

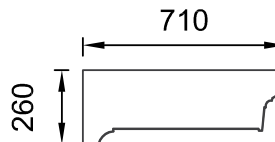

Art.Nr.: FGXBRG

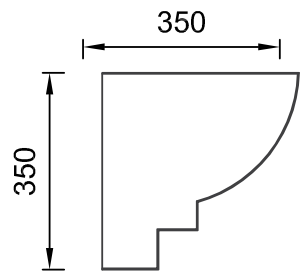

Art.Nr.: FGXB RM

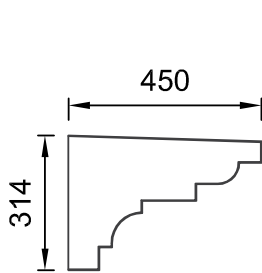

Art.Nr.: FGXBQY

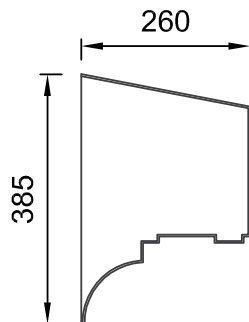

Art.Nr.: FGXBRC

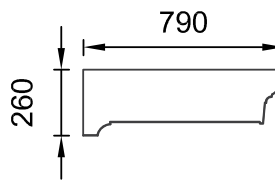

Art.Nr.: FGXBRH

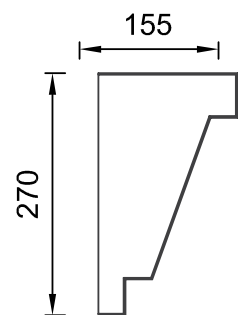

Art.Nr.: FGXB RN



QR-Code einfach scannen und
Austrotherm Materiallisten-Generator
online nutzen.

Austrotherm Gesimseprofil

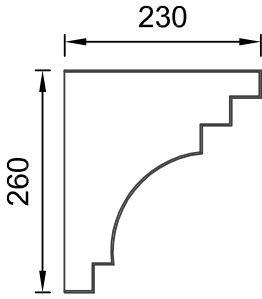

Art.Nr.: FGXBRO

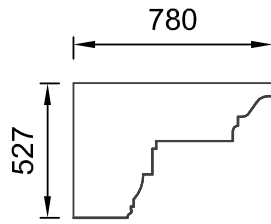

Art.Nr.: FGXBRT

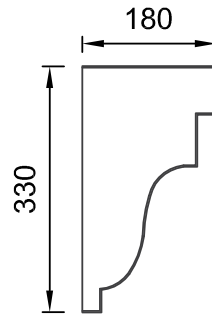

Art.Nr.: FGXBRX

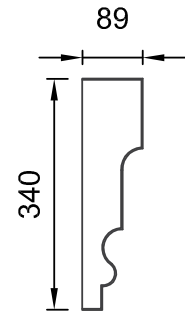

Art.Nr.: FGXBSB

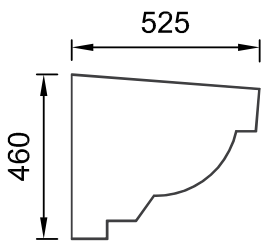

Art.Nr.: FGXBRP

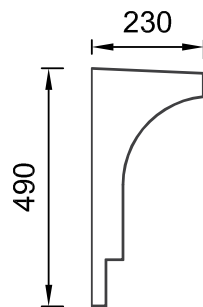

Art.Nr.: FGXBRU

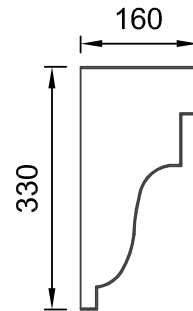

Art.Nr.: FGXBRY

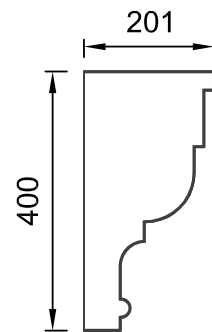

Art.Nr.: FGXBSC

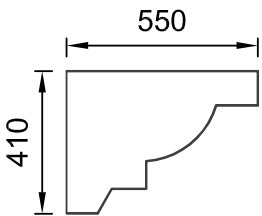

Art.Nr.: FGXBRQ

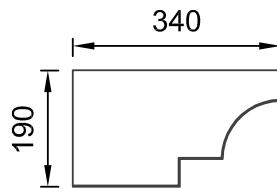

Art.Nr.: FGXBRV

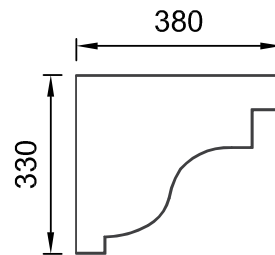

Art.Nr.: FGXBRZ

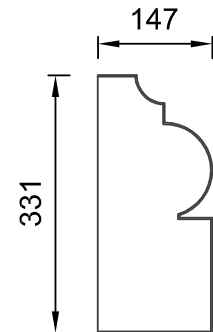

Art.Nr.: FGXBSD

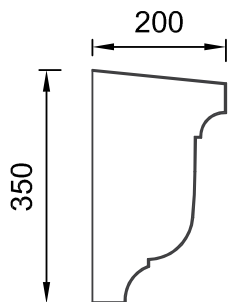

Art.Nr.: FGXBRS

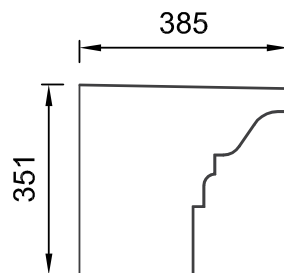

Art.Nr.: FGXBRW

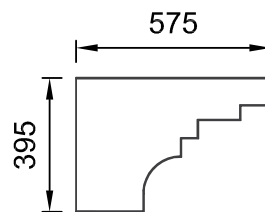

Art.Nr.: FGXBSA

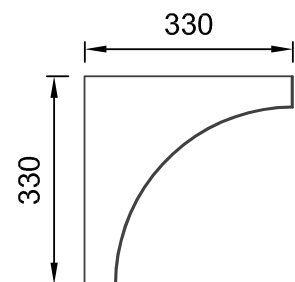

Art.Nr.: FGXBSE



QR-Code einfach scannen und
Austrotherm Materiallisten-Generator
online nutzen.

Austrotherm Gesimseprofil

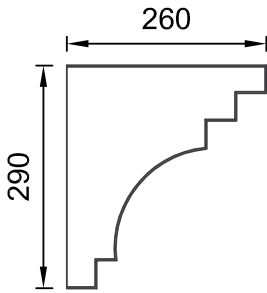

Art.Nr.: FGXBSF

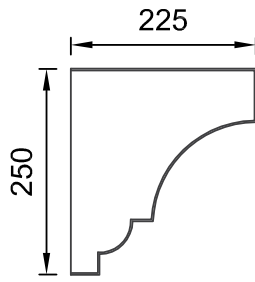

Art.Nr.: FGXBSO

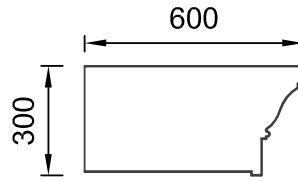

Art.Nr.: FGXBSU

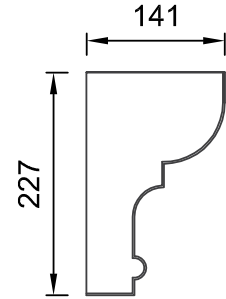

Art.Nr.: FGXBSZ

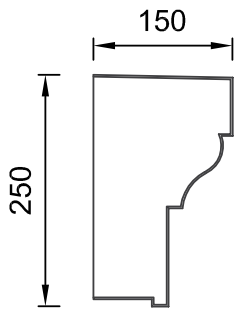

Art.Nr.: FGXBSG

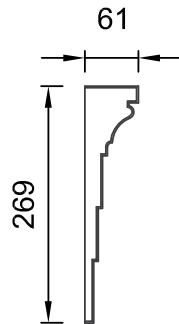

Art.Nr.: FGXBSQ

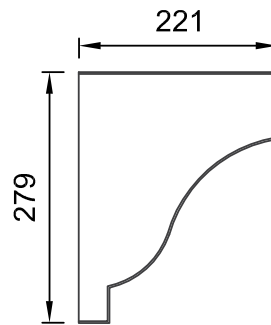

Art.Nr.: FGXBSW

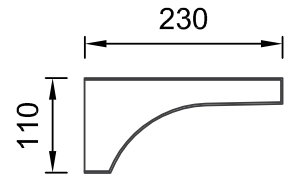

Art.Nr.: FGXBTA

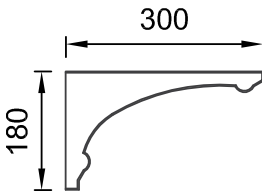

Art.Nr.: FGXBSM

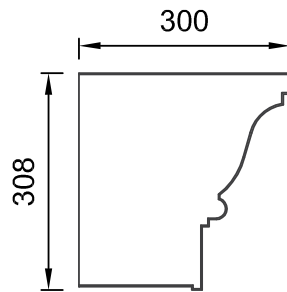

Art.Nr.: FGXBRS

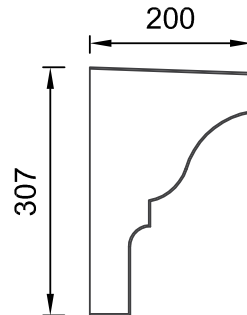

Art.Nr.: FGXBXS

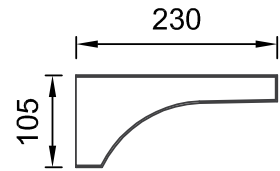

Art.Nr.: FGXBTB

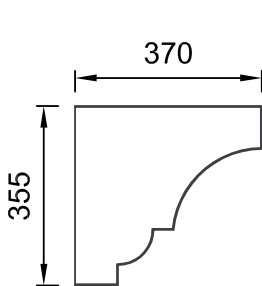

Art.Nr.: FGXBNS

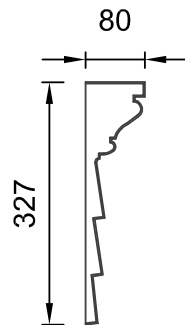

Art.Nr.: FGXBSS

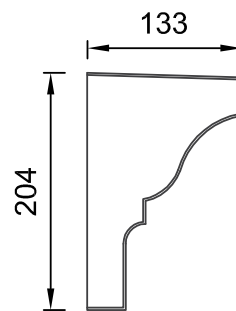

Art.Nr.: FGXBYS

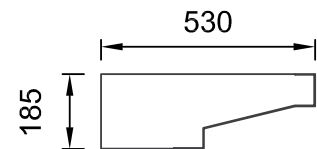

Art.Nr.: FGXBTC



QR-Code einfach scannen und
Austrotherm Materiallisten-Generator
online nutzen.

Austrotherm Gesimseprofil

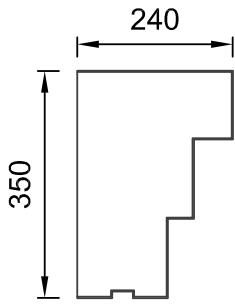

Art.Nr.: FGXBTD

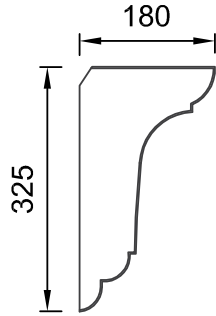

Art.Nr.: FGXBTK

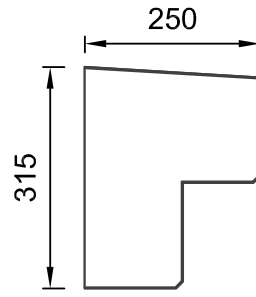

Art.Nr.: FGXBTQ

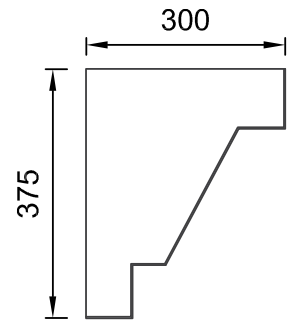

Art.Nr.: FGXBUA

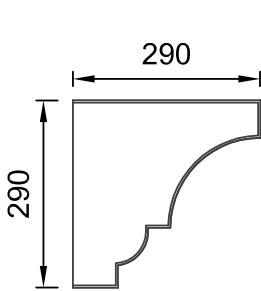

Art.Nr.: FGXBTE

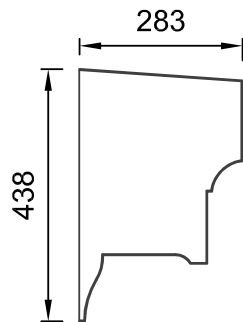

Art.Nr.: FGXBTM

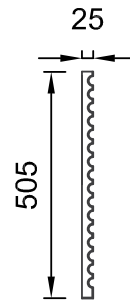

Art.Nr.: FGXBTR

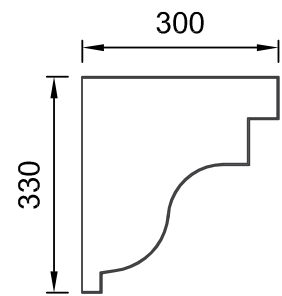

Art.Nr.: FGXBUC

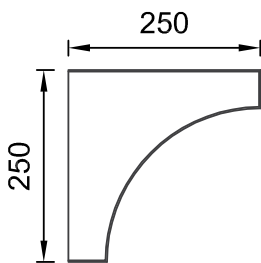

Art.Nr.: FGXBTH

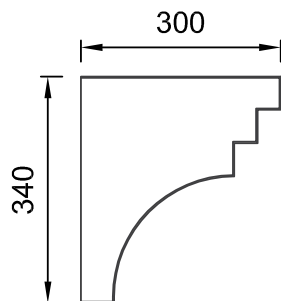

Art.Nr.: FGXBTO

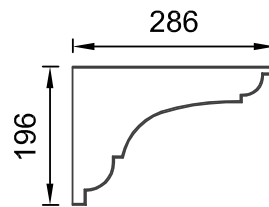

Art.Nr.: FGXBTS

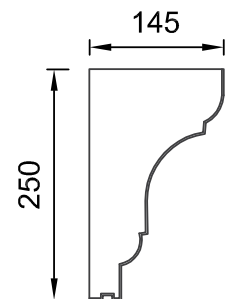

Art.Nr.: FGXBUD

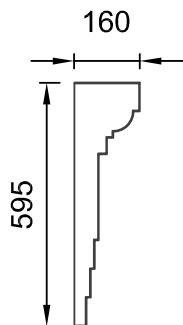

Art.Nr.: FGXBTI

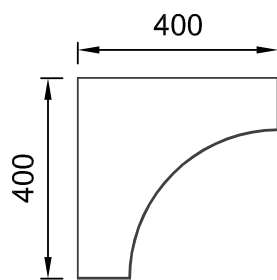

Art.Nr.: FGXBTP

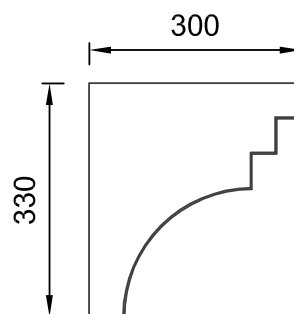

Art.Nr.: FGXBTV

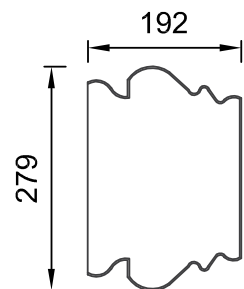

Art.Nr.: FGXBUG



QR-Code einfach scannen und
Austrotherm Materiallisten-Generator
online nutzen.

Austrotherm Gesimseprofil

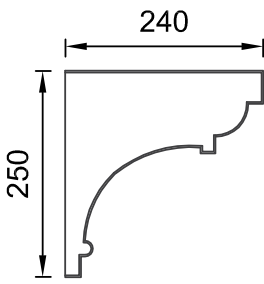

Art.Nr.: FGXBUH

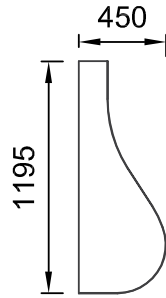

Art.Nr.: FGXBUN

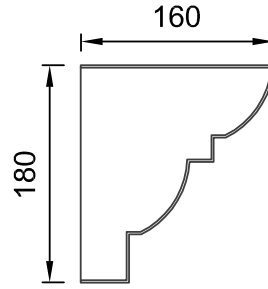

Art.Nr.: FGXBUV

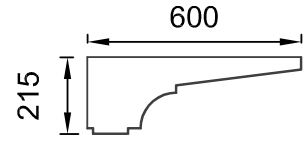

Art.Nr.: FGXBUZ

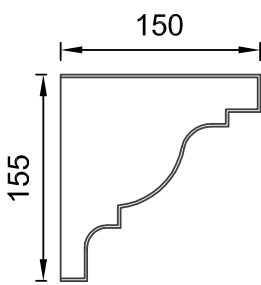

Art.Nr.: FGXBUJ

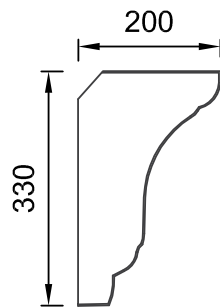

Art.Nr.: FGXBUO

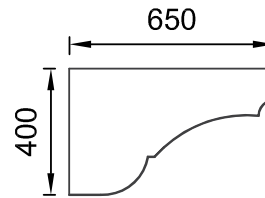

Art.Nr.: FGXBUI

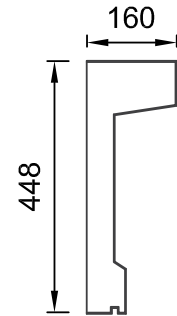

Art.Nr.: FGXBVB

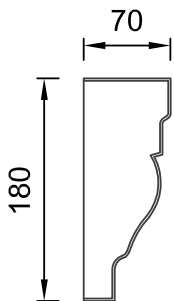

Art.Nr.: FGXBUK

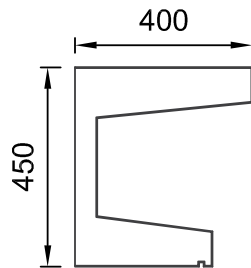

Art.Nr.: FGXBUT

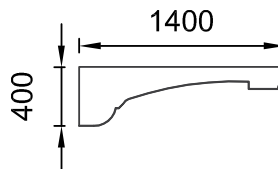

Art.Nr.: FGXBUX

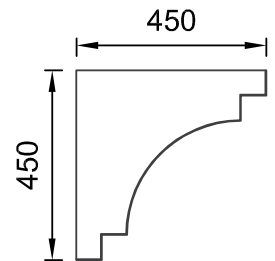

Art.Nr.: FGXBVC

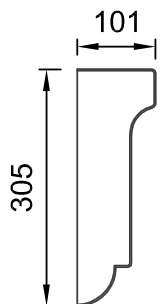

Art.Nr.: FGXBUL

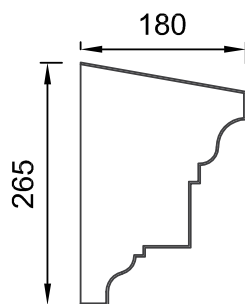

Art.Nr.: FGXBUII

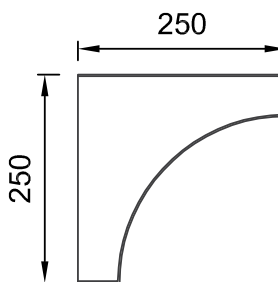

Art.Nr.: FGXBUIY

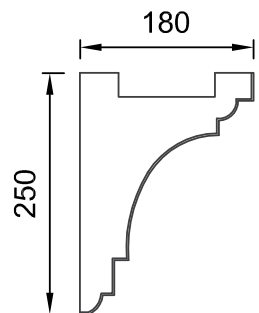

Art.Nr.: FGXBVD



QR-Code einfach scannen und
Austrotherm Materiallisten-Generator
online nutzen.

Austrotherm Gesimseprofil

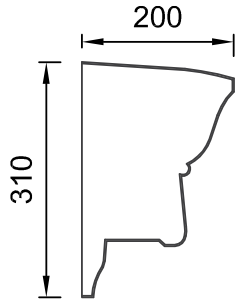

Art.Nr.: FGXBVE

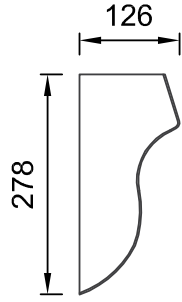

Art.Nr.: FGXBVI

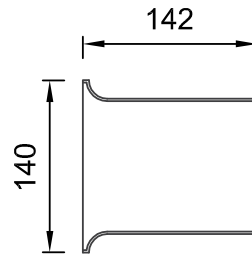

Art.Nr.: FGXBVQ

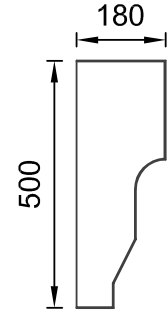

Art.Nr.: FGXBWC

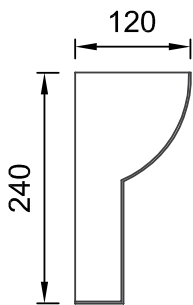

Art.Nr.: FGXBVF

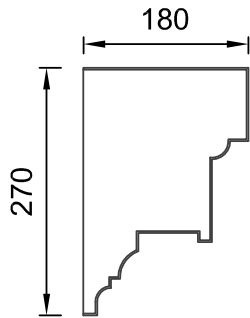

Art.Nr.: FGXBVJ

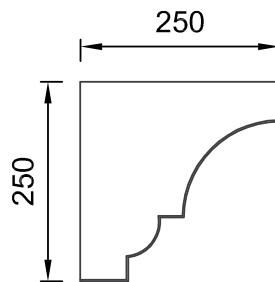

Art.Nr.: FGXBVR

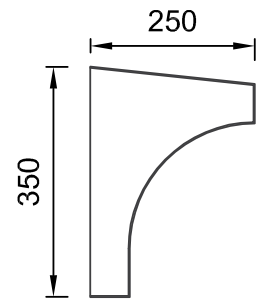

Art.Nr.: FGXBWD

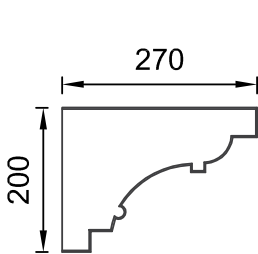

Art.Nr.: FGXBVG

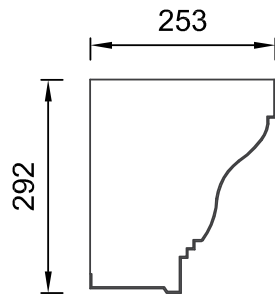

Art.Nr.: FGXBVK

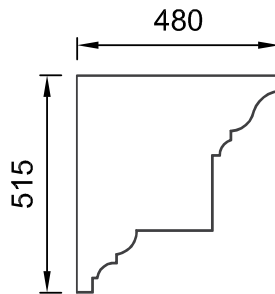

Art.Nr.: FGXBVT

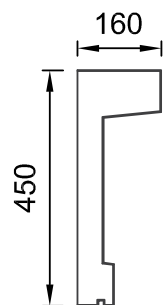

Art.Nr.: FGXBWE

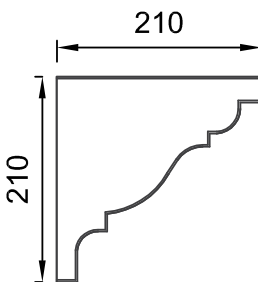

Art.Nr.: FGXBVH

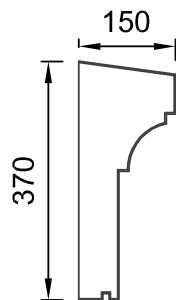

Art.Nr.: FGXBVM

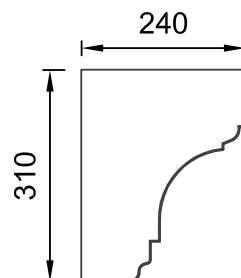

Art.Nr.: FGXBWB

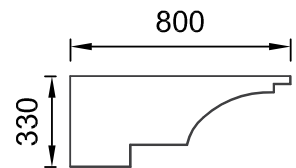

Art.Nr.: FGXBWF



QR-Code einfach scannen und
Austrotherm Materiallisten-Generator
online nutzen.

Austrotherm Gesimseprofil

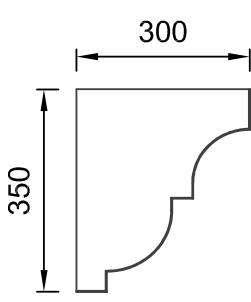

Art.Nr.: FGXBWG

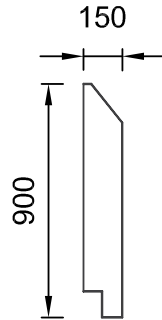

Art.Nr.: FGXBWK

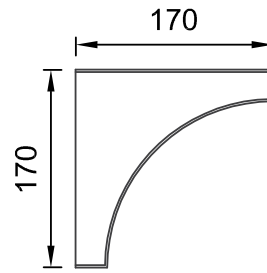

Art.Nr.: FGXBWP

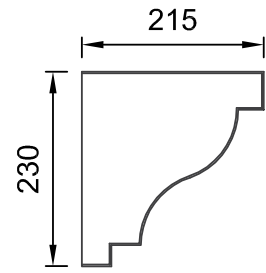

Art.Nr.: FGXBWT

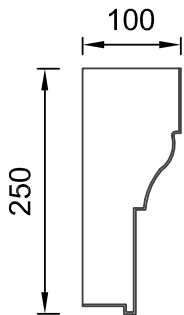

Art.Nr.: FGXBWH

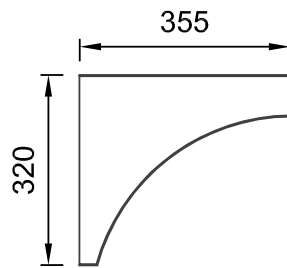

Art.Nr.: FGXBWL

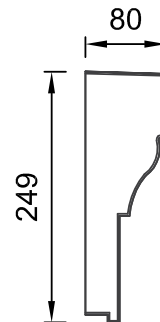

Art.Nr.: FGXBWQ

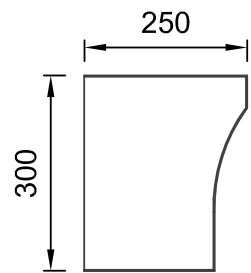

Art.Nr.: FGXBWU

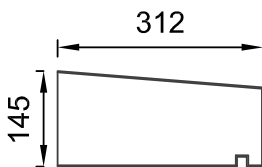

Art.Nr.: FGXBWI

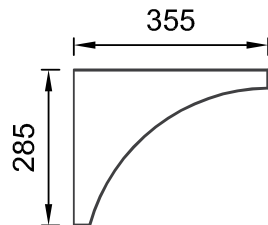

Art.Nr.: FGXBWM

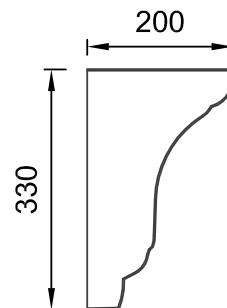

Art.Nr.: FGXBWR

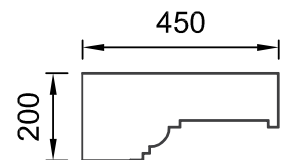

Art.Nr.: FGXBWW

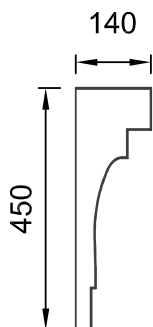

Art.Nr.: FGXBWJ

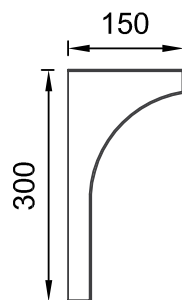

Art.Nr.: FGXBWO

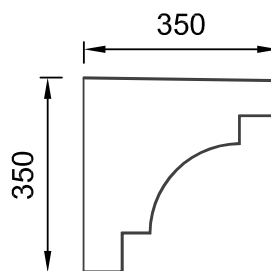

Art.Nr.: FGXBWS

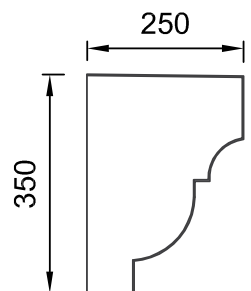

Art.Nr.: FGXBWW



QR-Code einfach scannen und
Austrotherm Materiallisten-Generator
online nutzen.

Austrotherm Gesimseprofil

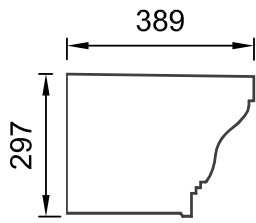

Art.Nr.: FGXBWX

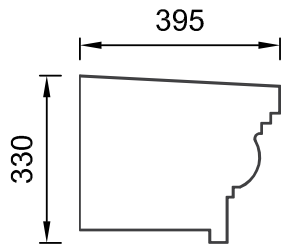

Art.Nr.: FGXBXB

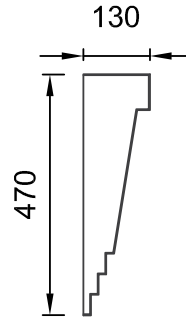

Art.Nr.: FGXBXG

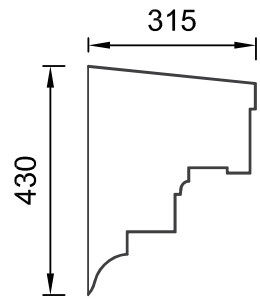

Art.Nr.: FGXB XK

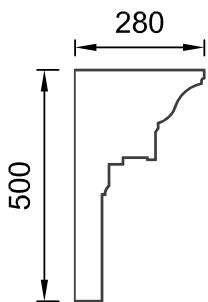

Art.Nr.: FGXBWY

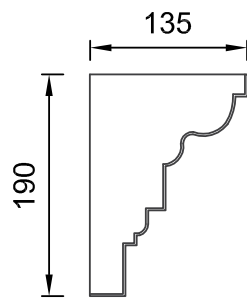

Art.Nr.: FGXBXC

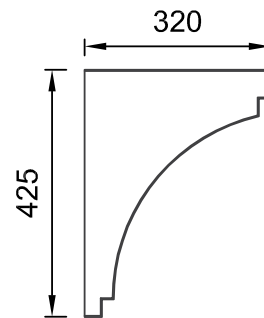

Art.Nr.: FGXBXH

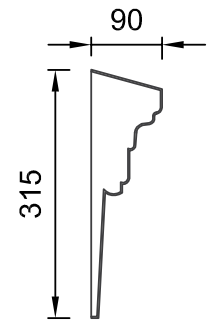

Art.Nr.: FGXBXL

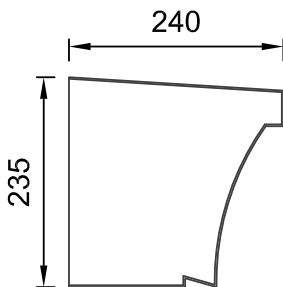

Art.Nr.: FGXBWZ

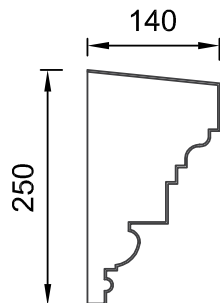

Art.Nr.: FGXBXD

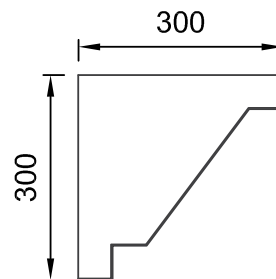

Art.Nr.: FGXBXI

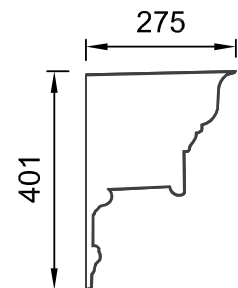

Art.Nr.: FGXBXM

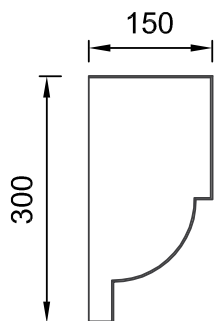

Art.Nr.: FGXBXA

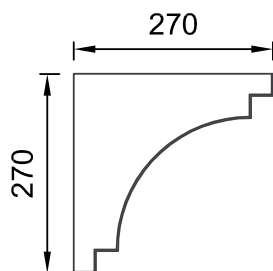

Art.Nr.: FGXBXF

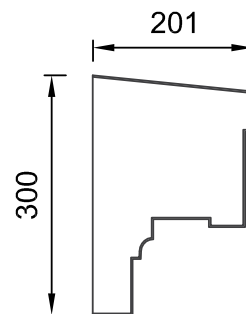

Art.Nr.: FGXBXJ

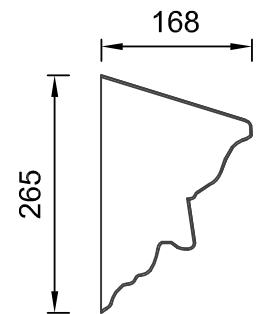

Art.Nr.: FGXBXN



QR-Code einfach scannen und
Austrotherm Materiallisten-Generator
online nutzen.

Austrotherm Gesimseprofil

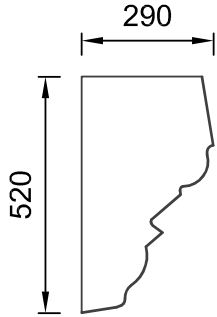

Art.Nr.: FGXBXQ

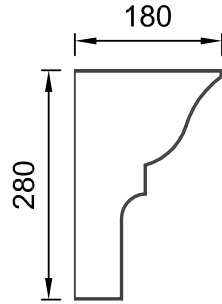

Art.Nr.: FGXBXV

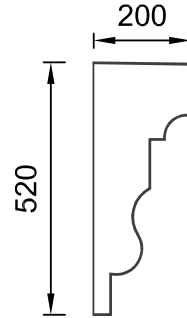

Art.Nr.: FGXBYC

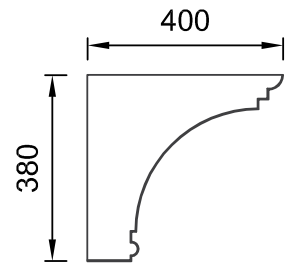

Art.Nr.: FGXBYH

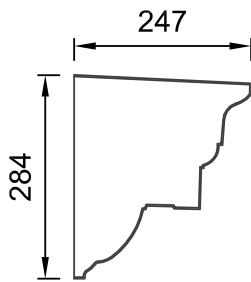

Art.Nr.: FGXBXR

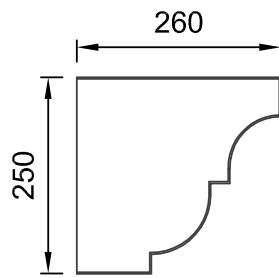

Art.Nr.: FGXBWX

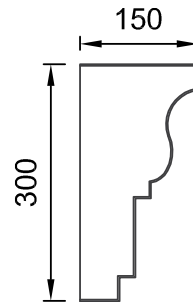

Art.Nr.: FGXBYD

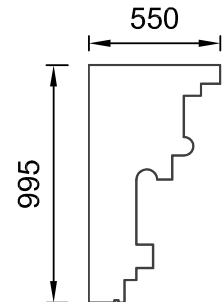

Art.Nr.: FGXBYI

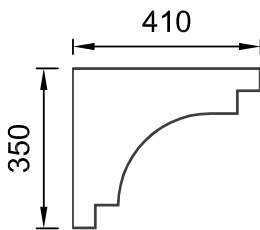

Art.Nr.: FGXBXT

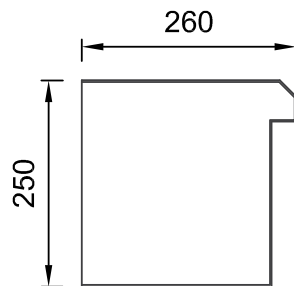

Art.Nr.: FGXBXX

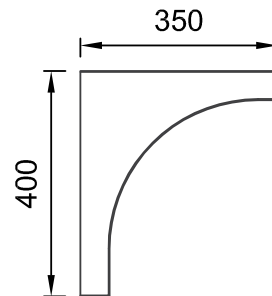

Art.Nr.: FGXBYF

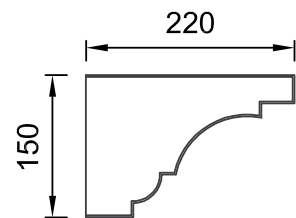

Art.Nr.: FGXBYK

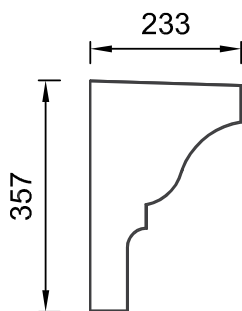

Art.Nr.: FGXB XU

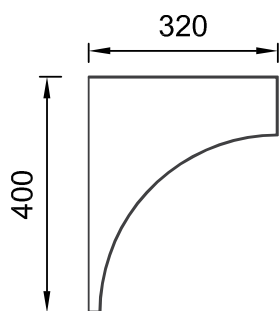

Art.Nr.: FGXB XZ

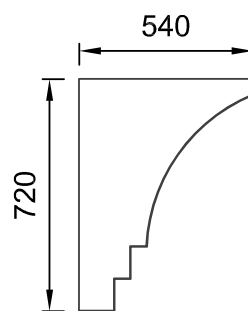

Art.Nr.: FGXBYG

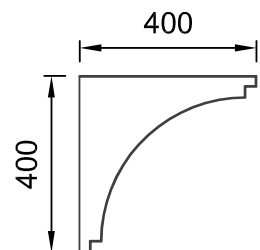

Art.Nr.: FGXB YL



QR-Code einfach scannen und
Austrotherm Materiallisten-Generator
online nutzen.

Austrotherm Gesimseprofil

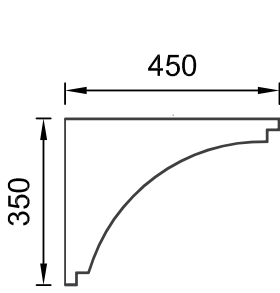

Art.Nr.: FGXBYM

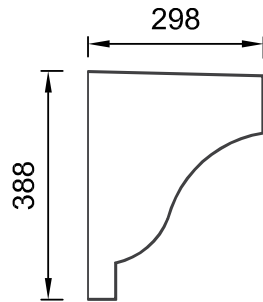

Art.Nr.: FGXBZC

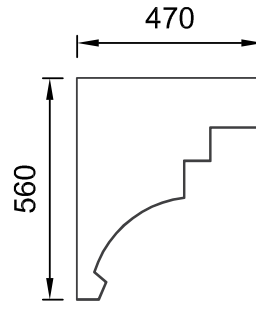

Art.Nr.: FGXBZG

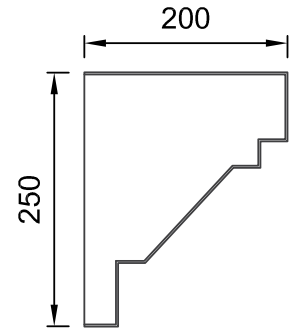

Art.Nr.: FGXBZK

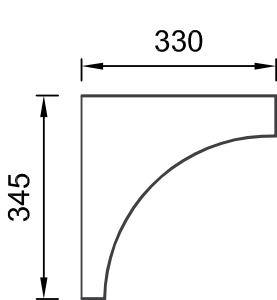

Art.Nr.: FGXBYN

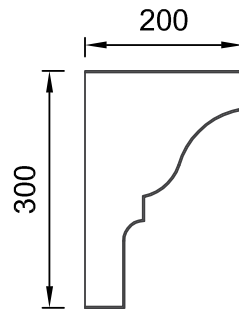

Art.Nr.: FGXBZD

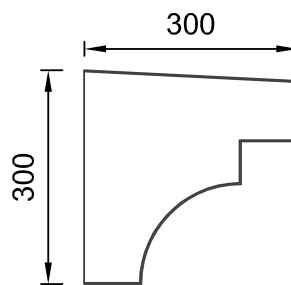

Art.Nr.: FGXBZH

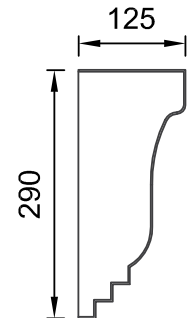

Art.Nr.: FGXBZM

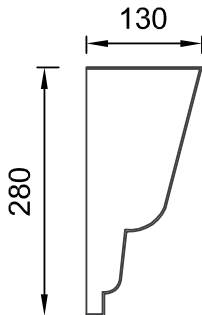

Art.Nr.: FGXBYY

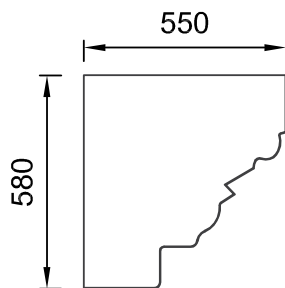

Art.Nr.: FGXBZE

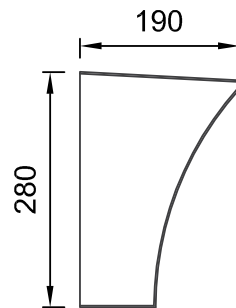

Art.Nr.: FGXBZI

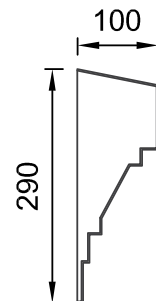

Art.Nr.: FGXBZN

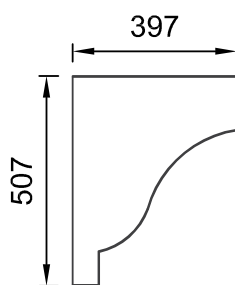

Art.Nr.: FGXBZB

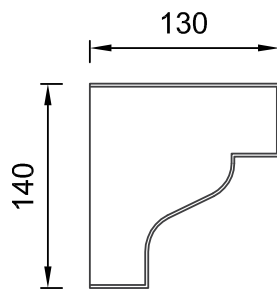

Art.Nr.: FGXBZF

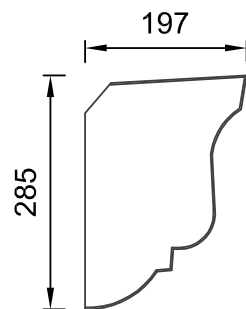

Art.Nr.: FGXBZJ

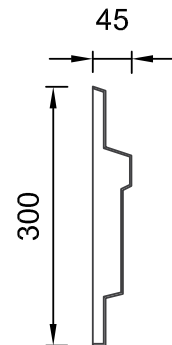

Art.Nr.: FGXBZO



QR-Code einfach scannen und
Austrotherm Materiallisten-Generator
online nutzen.

Austrotherm Gesimseprofil

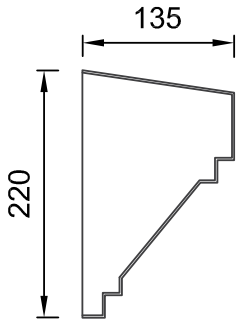

Art.Nr.: FGXBZP

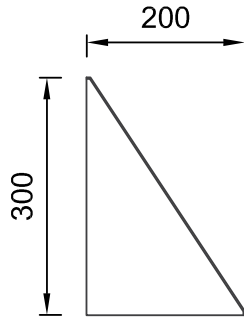

Art.Nr.: FGXBZY

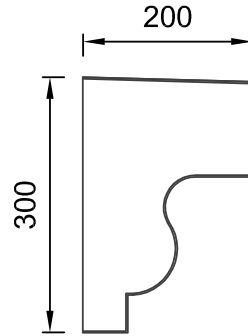

Art.Nr.: FGXCAD

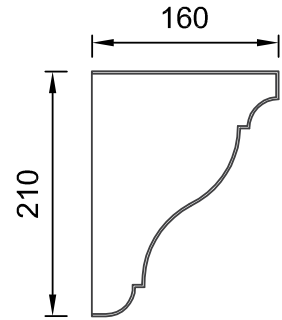

Art.Nr.: FGXCAI

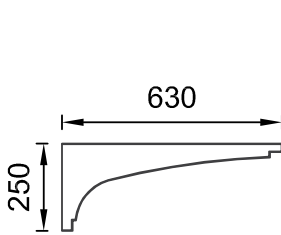

Art.Nr.: FGXBZQ

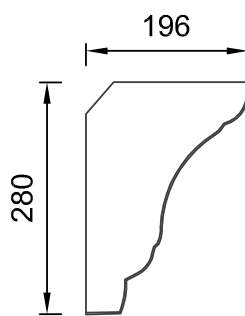

Art.Nr.: FGXBZZ

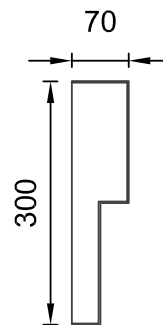

Art.Nr.: FGXCAE

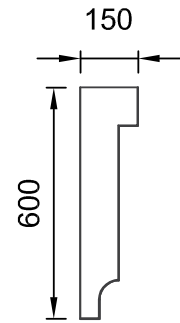

Art.Nr.: FGXCAJ

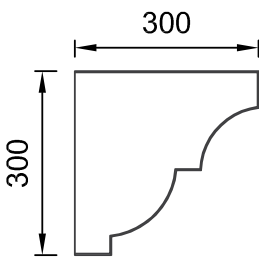

Art.Nr.: FGXBZR

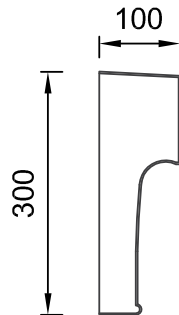

Art.Nr.: FGXCAB

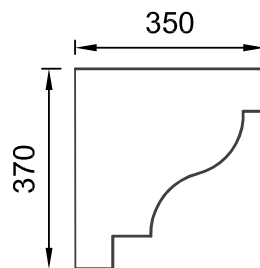

Art.Nr.: FGXCAF

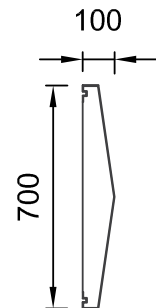

Art.Nr.: FGXCAK

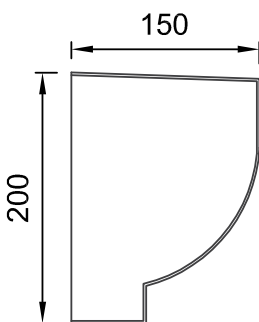

Art.Nr.: FGXBZS

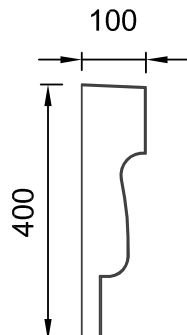

Art.Nr.: FGXCAC

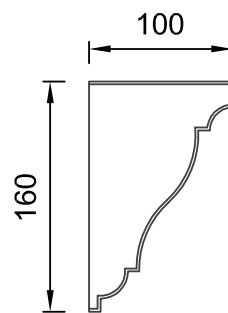

Art.Nr.: FGXCAG

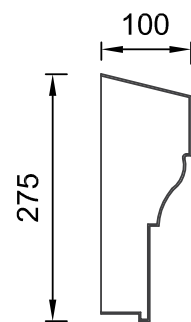

Art.Nr.: FGXCAL



QR-Code einfach scannen und
Austrotherm Materiallisten-Generator
online nutzen.

Austrotherm Gesimseprofil

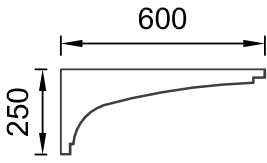

Art.Nr.: FGXCAM

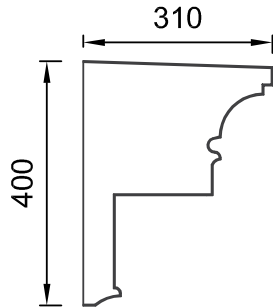

Art.Nr.: FGXCAQ

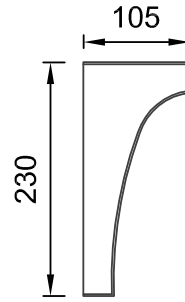

Art.Nr.: FGXCAU

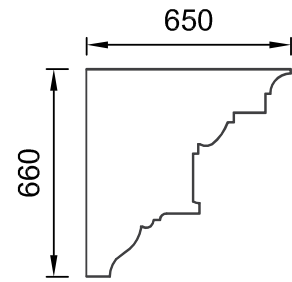

Art.Nr.: FGXCAY

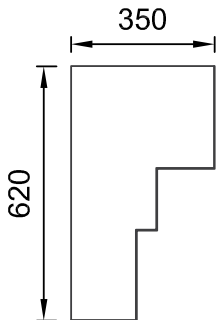

Art.Nr.: FGXCAN

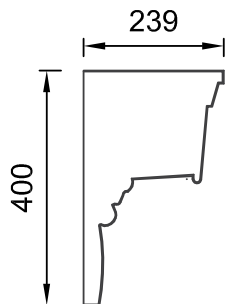

Art.Nr.: FGXCAR

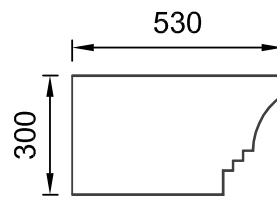

Art.Nr.: FGXCAV

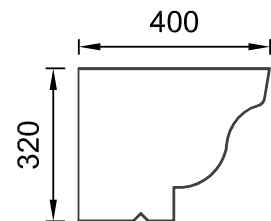

Art.Nr.: FGXCAZ

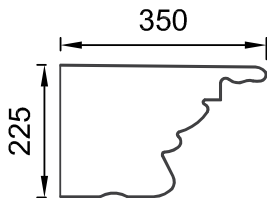

Art.Nr.: FGXCAO

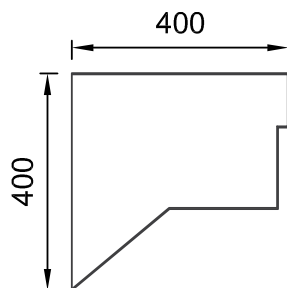

Art.Nr.: FGXCAS

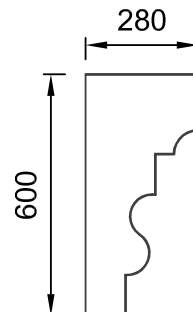

Art.Nr.: FGXCAW

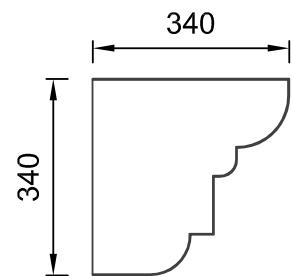

Art.Nr.: FGXCBA

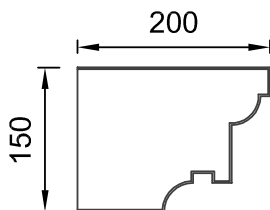

Art.Nr.: FGXCAP

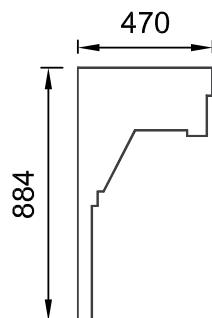

Art.Nr.: FGXCAT

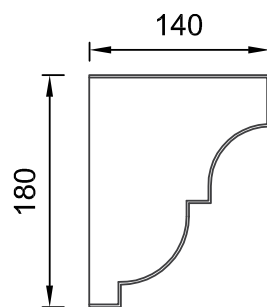

Art.Nr.: FGXCAX

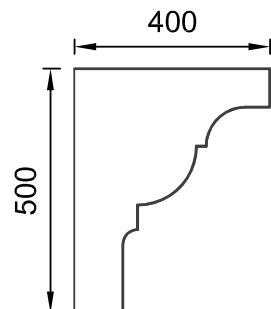

Art.Nr.: FGXCBB



QR-Code einfach scannen und
Austrotherm Materiallisten-Generator
online nutzen.

Austrotherm Gesimseprofil

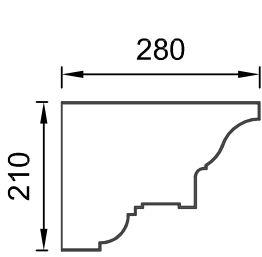

Art.Nr.: FGXCBE

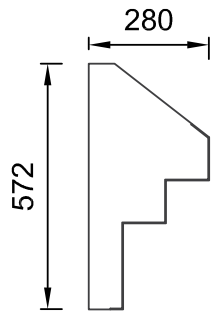

Art.Nr.: FGXCBJ

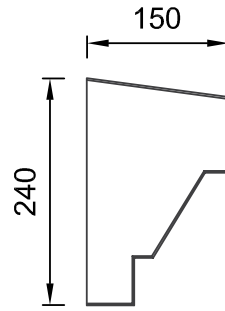

Art.Nr.: FGXCBN

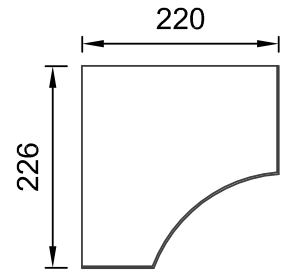

Art.Nr.: FGXCBR

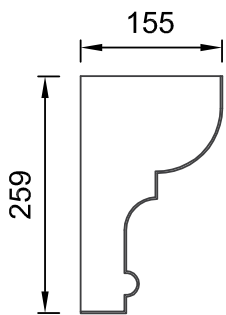

Art.Nr.: FGXCBF

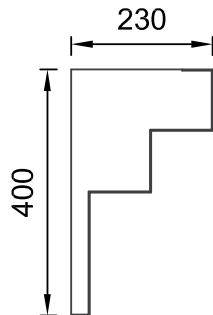

Art.Nr.: FGXCBK

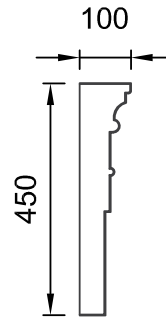

Art.Nr.: FGXCBO

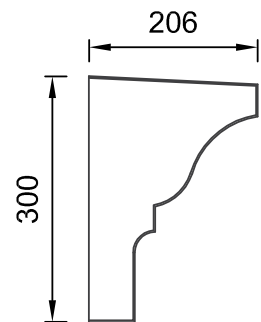

Art.Nr.: FGXCBT

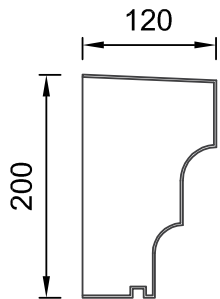

Art.Nr.: FGXCBG

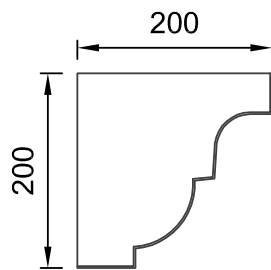

Art.Nr.: FGXCBL

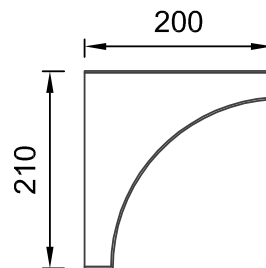

Art.Nr.: FGXCBP

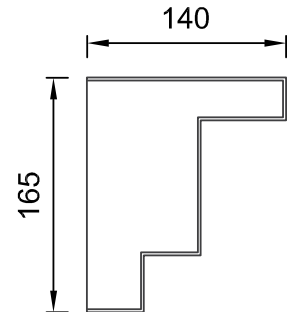

Art.Nr.: FGXCBU

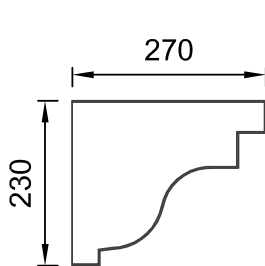

Art.Nr.: FGXCBH

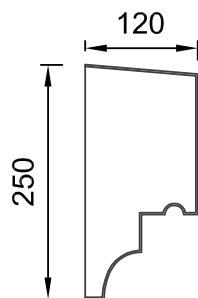

Art.Nr.: FGXCBM

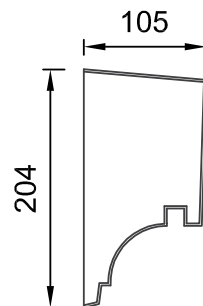

Art.Nr.: FGXCBO

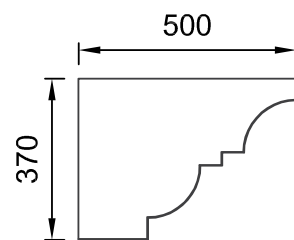

Art.Nr.: FGXCBO



QR-Code einfach scannen und
Austrotherm Materiallisten-Generator
online nutzen.

Austrotherm Gesimseprofil

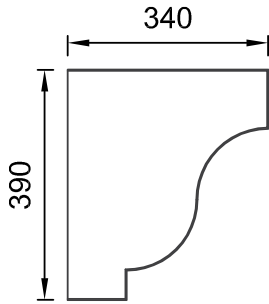

Art.Nr.: FGXCBW

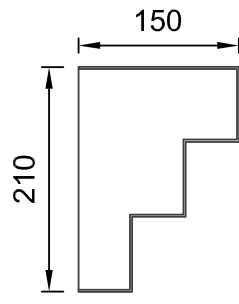

Art.Nr.: FGXCCC

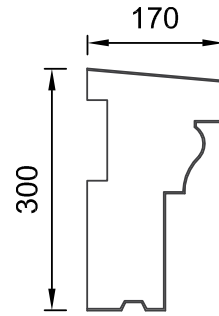

Art.Nr.: FGXCCL

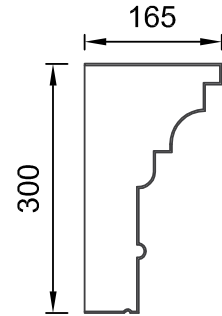

Art.Nr.: FGXCCN

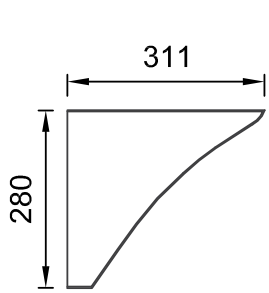

Art.Nr.: FGXCBY

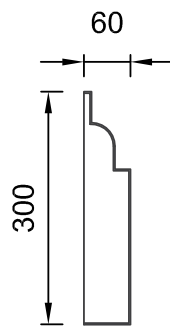

Art.Nr.: FGXCDD

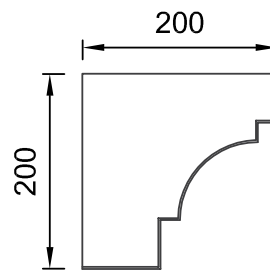

Art.Nr.: FGXCCE

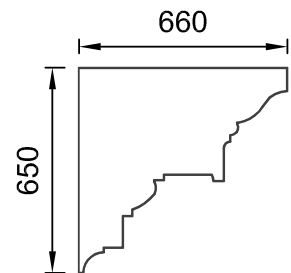

Art.Nr.: FGXCCE

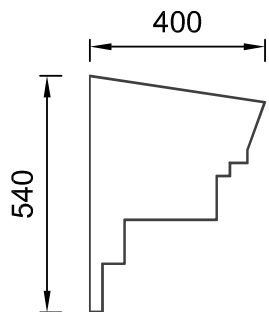

Art.Nr.: FGXCBZ

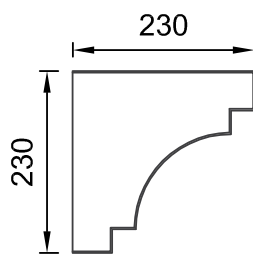

Art.Nr.: FGXCCE

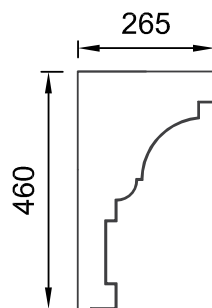

Art.Nr.: FGXCCL

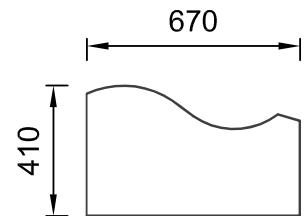

Art.Nr.: FGXCCE

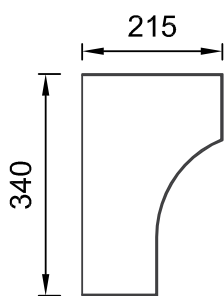

Art.Nr.: FGXCCE

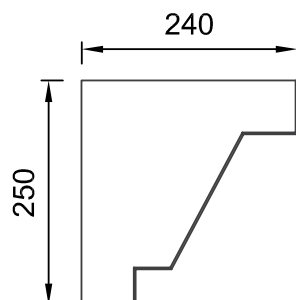

Art.Nr.: FGXCCH

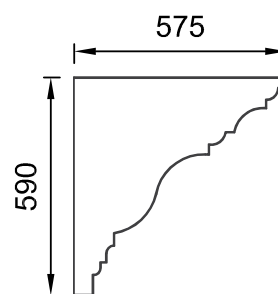

Art.Nr.: FGXCCE

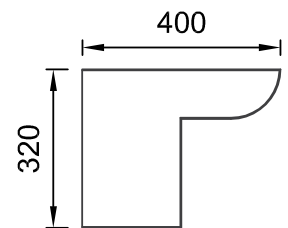

Art.Nr.: FGXCCE



QR-Code einfach scannen und
Austrotherm Materiallisten-Generator
online nutzen.

Austrotherm Gesimseprofil

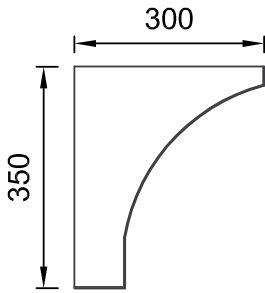

Art.Nr.: FGXCCV

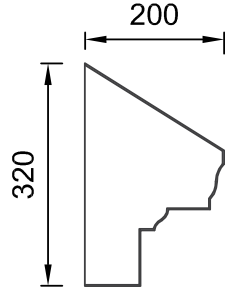

Art.Nr.: FGXCDA

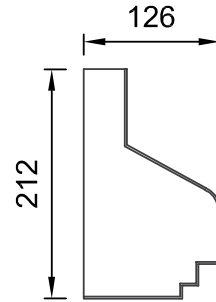

Art.Nr.: FGXCDF

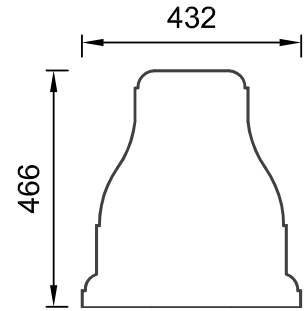

Art.Nr.: FGXCDK

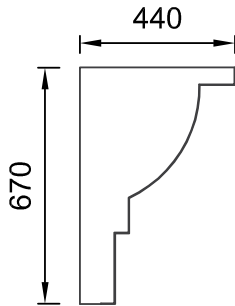

Art.Nr.: FGXCCX

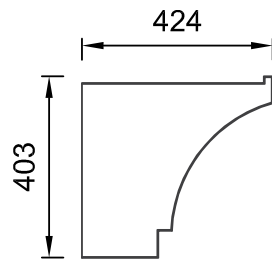

Art.Nr.: FGXCDC

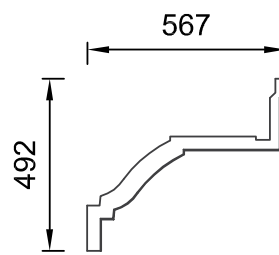

Art.Nr.: FGXC DG

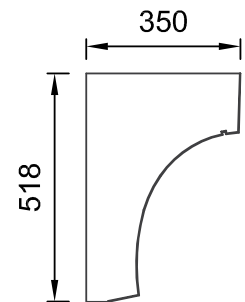

Art.Nr.: FGXCDL

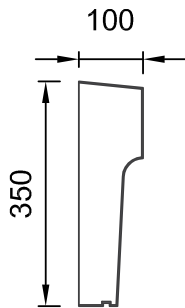

Art.Nr.: FGXCCY

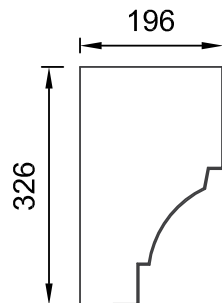

Art.Nr.: FGXCDD

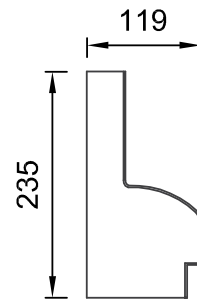

Art.Nr.: FGXC DH

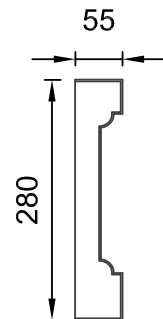

Art.Nr.: FGXC DM

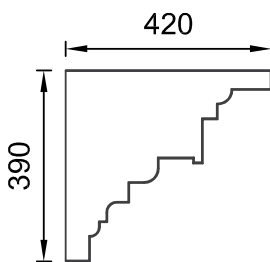

Art.Nr.: FGXCCZ

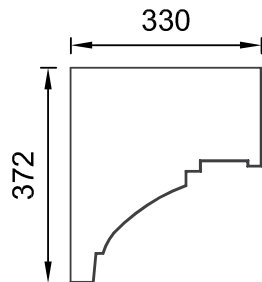

Art.Nr.: FGXC DE

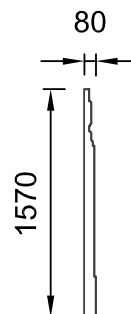

Art.Nr.: FGXC DJ

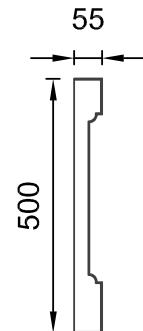

Art.Nr.: FGXC DN



QR-Code einfach scannen und
Austrotherm Materiallisten-Generator
online nutzen.

Austrotherm Gesimseprofil

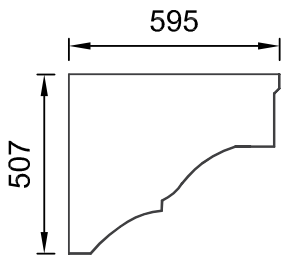

Art.Nr.: FGXCDO

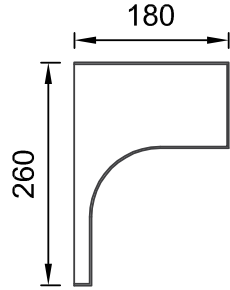

Art.Nr.: FGXCDS

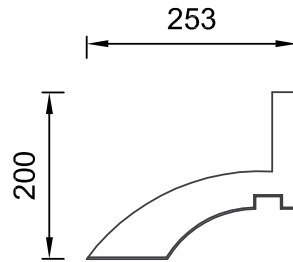

Art.Nr.: FGXCDW

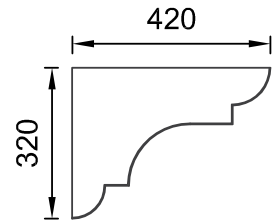

Art.Nr.: FGXCEA

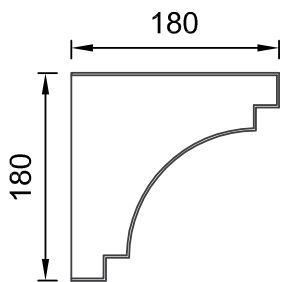

Art.Nr.: FGXCDP

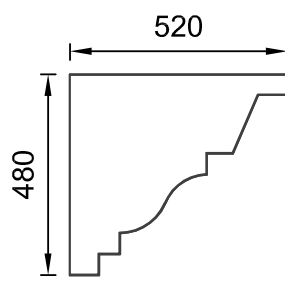

Art.Nr.: FGXCdT

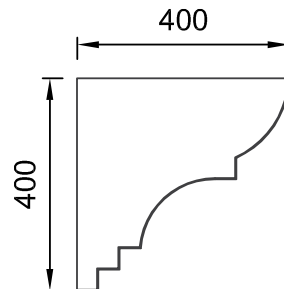

Art.Nr.: FGXCDX

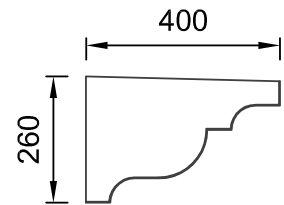

Art.Nr.: FGXCEB

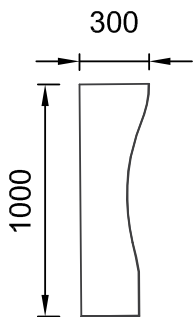

Art.Nr.: FGXCdq

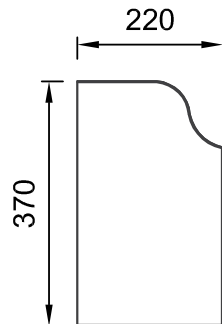

Art.Nr.: FGXCdu

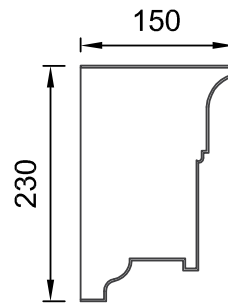

Art.Nr.: FGXCdy

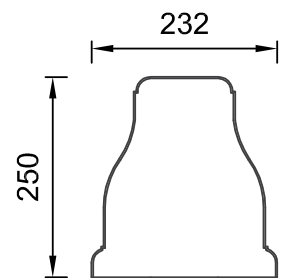

Art.Nr.: FGXCEC

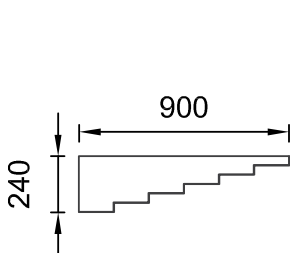

Art.Nr.: FGXCdr

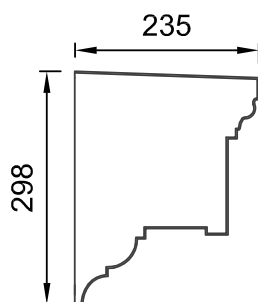

Art.Nr.: FGXCdv

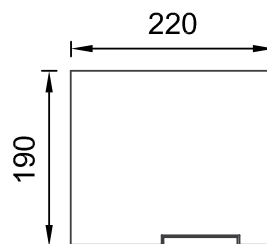

Art.Nr.: FGXCdz

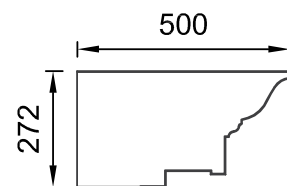

Art.Nr.: FGXCed



QR-Code einfach scannen und
Austrotherm Materialisten-Generator
online nutzen.

Austrotherm Gesimseprofil

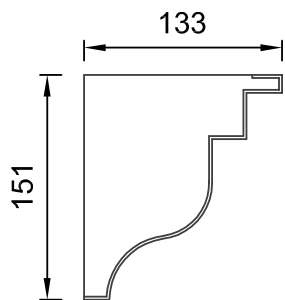

Art.Nr.: FGXCEE

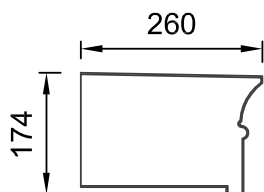

Art.Nr.: FGXCEK

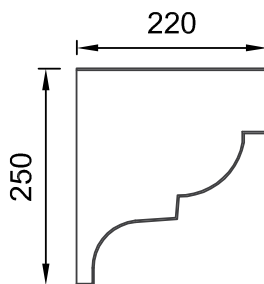

Art.Nr.: FGXCER

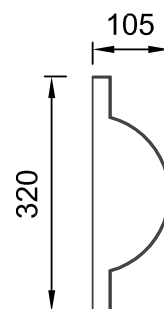

Art.Nr.: FGXCEX

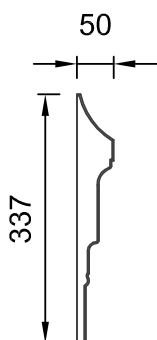

Art.Nr.: FGXCEF

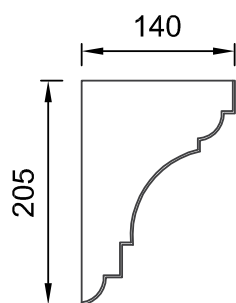

Art.Nr.: FGXCEM

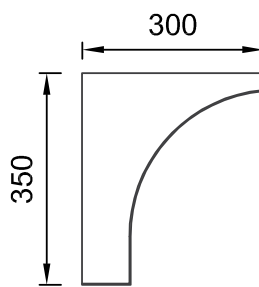

Art.Nr.: FGXCEU

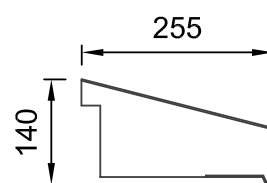

Art.Nr.: FGXCFA

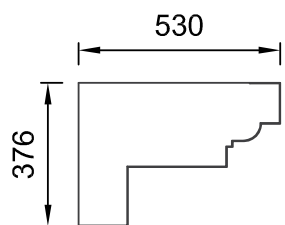

Art.Nr.: FGXCEG

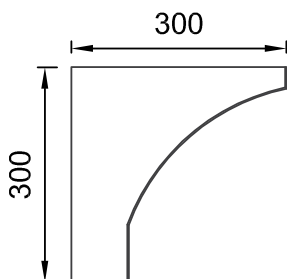

Art.Nr.: FGXCEN

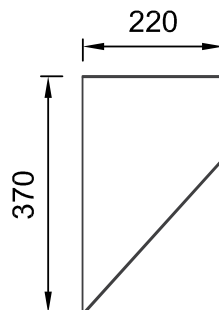

Art.Nr.: FGXCEV

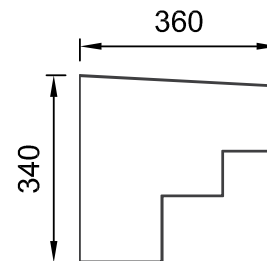

Art.Nr.: FGXCFB

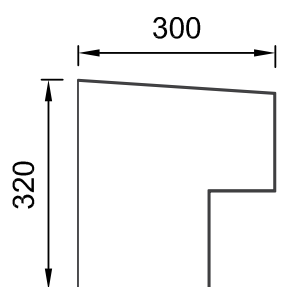

Art.Nr.: FGXCEH

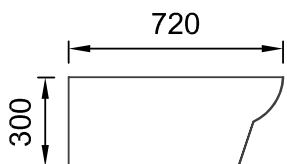

Art.Nr.: FGXCEO

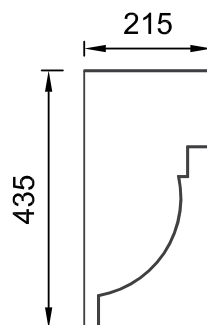

Art.Nr.: FGXCEW

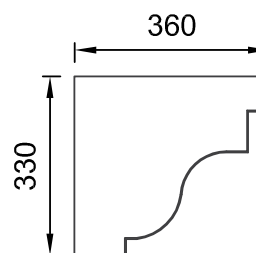

Art.Nr.: FGXCFC



QR-Code einfach scannen und
Austrotherm Materiallisten-Generator
online nutzen.

Austrotherm Gesimseprofil

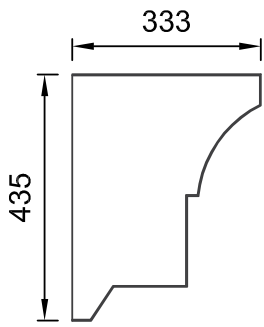

Art.Nr.: FGXCFH

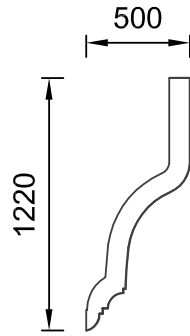

Art.Nr.: FGXCFO

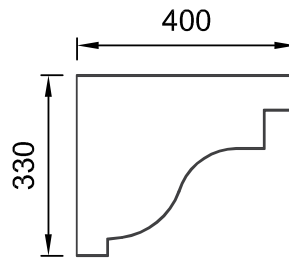

Art.Nr.: FGXCFV

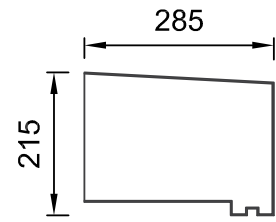

Art.Nr.: FGXCFZ

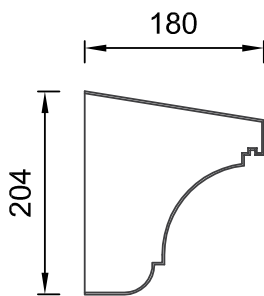

Art.Nr.: FGXCFL

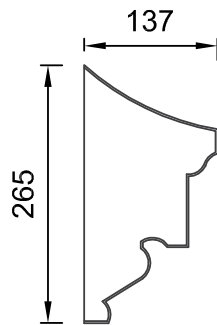

Art.Nr.: FGXCFF

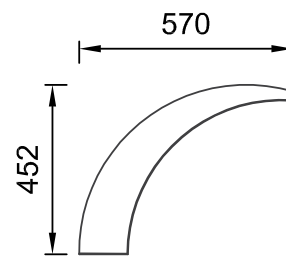

Art.Nr.: FGXCFW

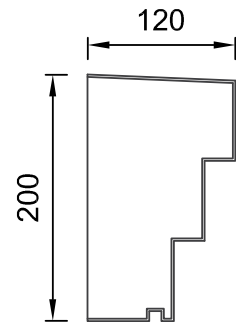

Art.Nr.: FGXCGA

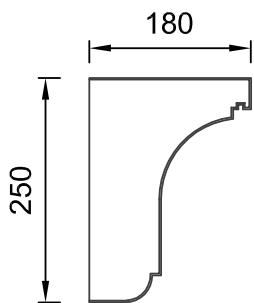

Art.Nr.: FGXCFM

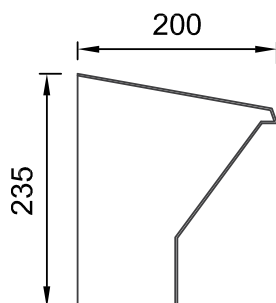

Art.Nr.: FGXCFQ

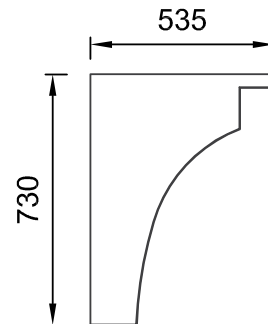

Art.Nr.: FGXCFX

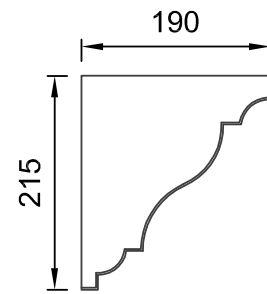

Art.Nr.: FGXCGB

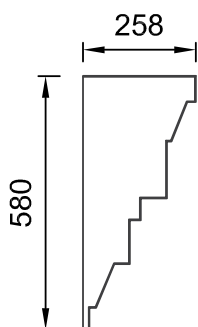

Art.Nr.: FGXCFN

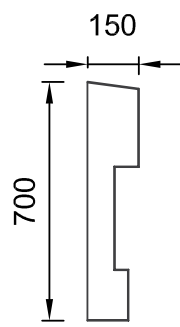

Art.Nr.: FGXCFR

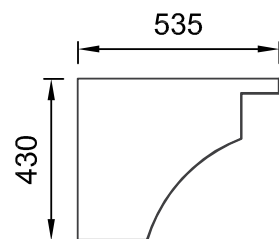

Art.Nr.: FGXCFY

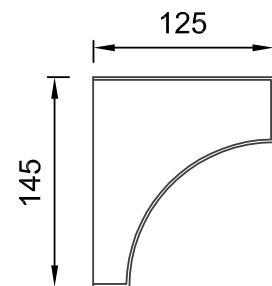

Art.Nr.: FGXCGC



QR-Code einfach scannen und
Austrotherm Materiallisten-Generator
online nutzen.

Austrotherm Gesimseprofil

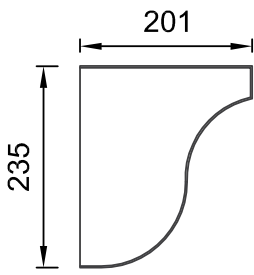

Art.Nr.: FGXCGD

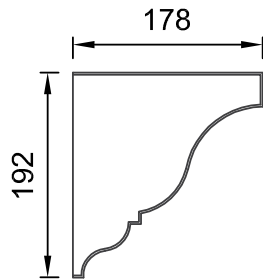

Art.Nr.: FGXCGH

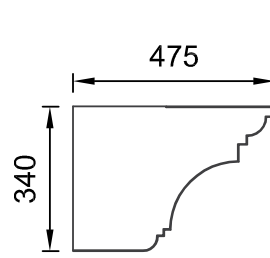

Art.Nr.: FGXCGL

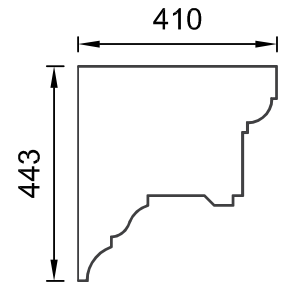

Art.Nr.: FGXCGP

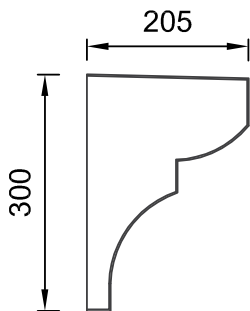

Art.Nr.: FGXCGE

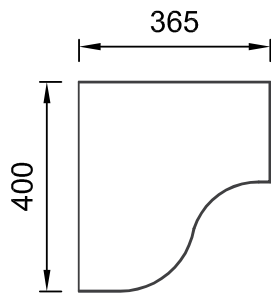

Art.Nr.: FGXCGI

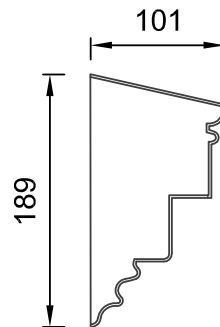

Art.Nr.: FGXCGM

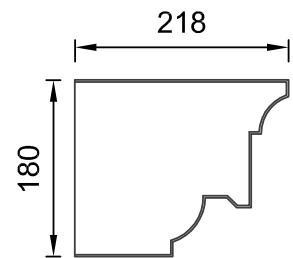

Art.Nr.: FGXCGQ

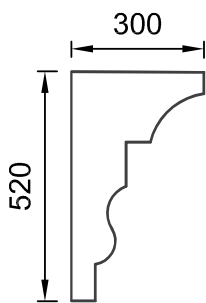

Art.Nr.: FGXCGF

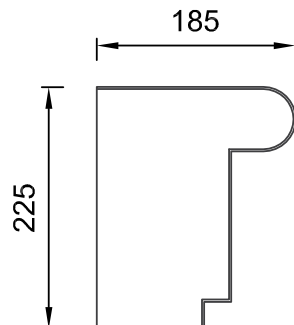

Art.Nr.: FGXCGJ

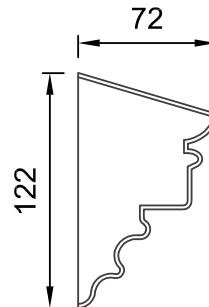

Art.Nr.: FGXCGN

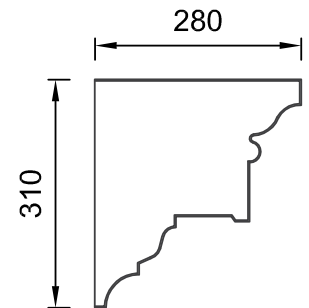

Art.Nr.: FGXCGR

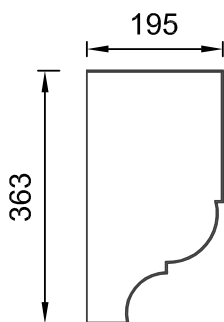

Art.Nr.: FGXCGC

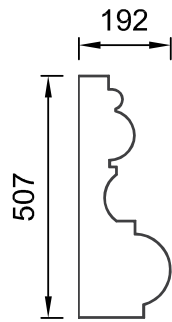

Art.Nr.: FGXCGK

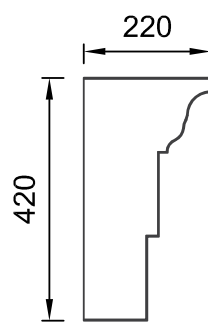

Art.Nr.: FGXCGO

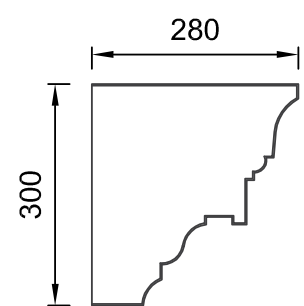

Art.Nr.: FGXCGS



QR-Code einfach scannen und
Austrotherm Materiallisten-Generator
online nutzen.

Austrotherm Gesimseprofil

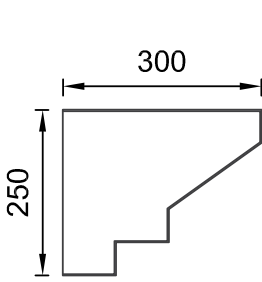

Art.Nr.: FGXCGV

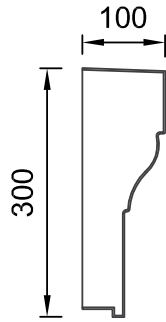

Art.Nr.: FGXCGZ

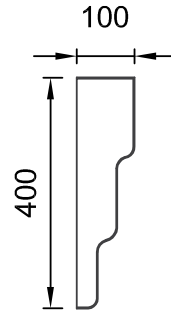

Art.Nr.: FGXCHD

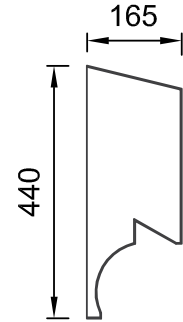

Art.Nr.: FGXCHH

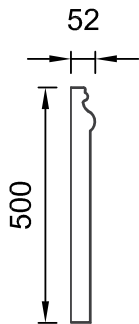

Art.Nr.: FGXCGW

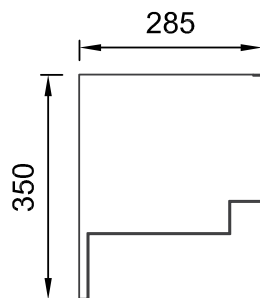

Art.Nr.: FGXCHA

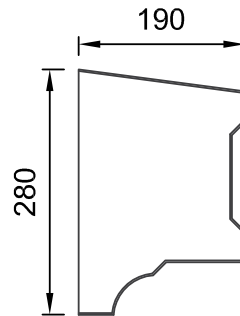

Art.Nr.: FGXCHE

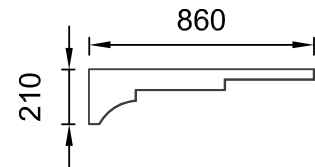

Art.Nr.: FGXCHJ

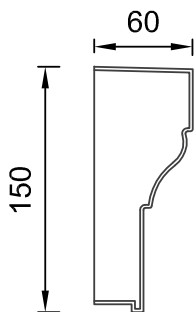

Art.Nr.: FGXCGX

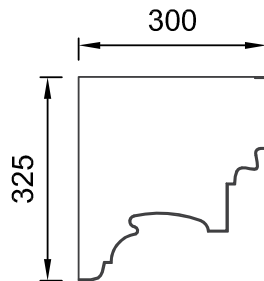

Art.Nr.: FGXCHB

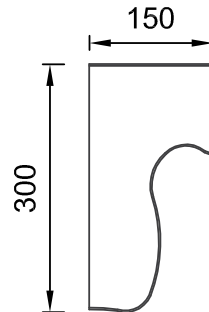

Art.Nr.: FGXCHF

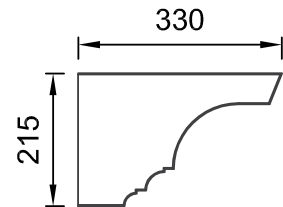

Art.Nr.: FGXCHL

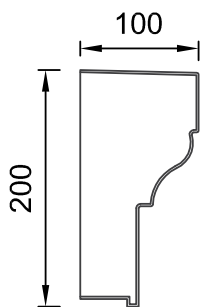

Art.Nr.: FGXCGY

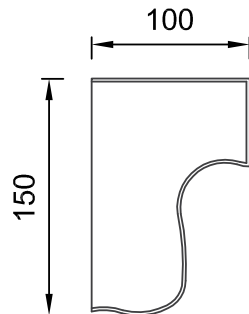

Art.Nr.: FGXCHC

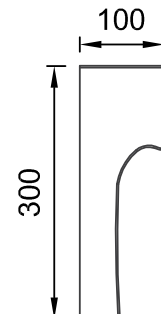

Art.Nr.: FGXCHG

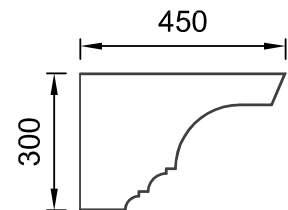

Art.Nr.: FGXCHM



QR-Code einfach scannen und
Austrotherm Materiallisten-Generator
online nutzen.

Austrotherm Gesimseprofil

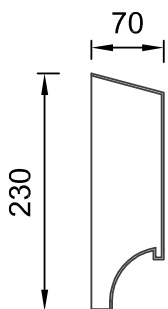

Art.Nr.: FGXCHP

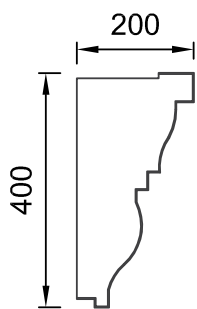

Art.Nr.: FGXCHU

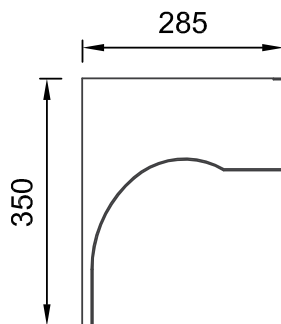

Art.Nr.: FGXCHY

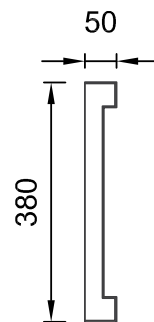

Art.Nr.: FGXCIC

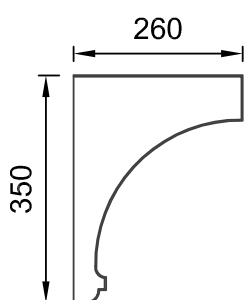

Art.Nr.: FGXCHQ

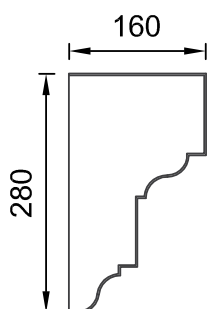

Art.Nr.: FGXCHV

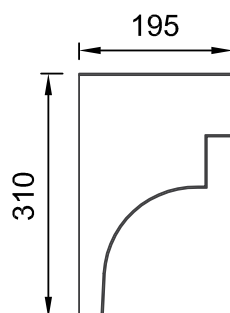

Art.Nr.: FGXCHZ

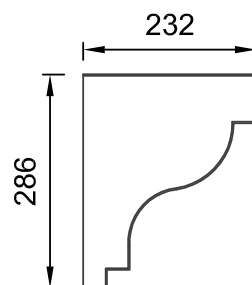

Art.Nr.: FGXCID

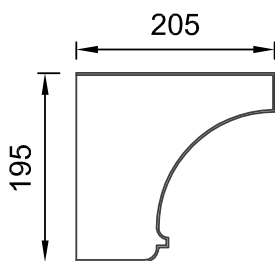

Art.Nr.: FGXCHR

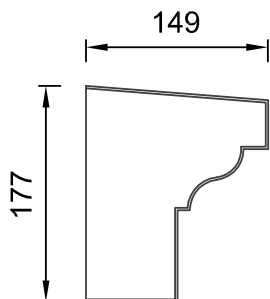

Art.Nr.: FGXCHW

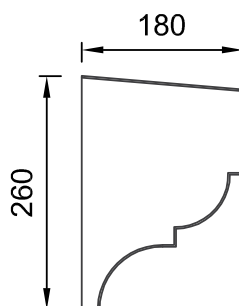

Art.Nr.: FGXCIA

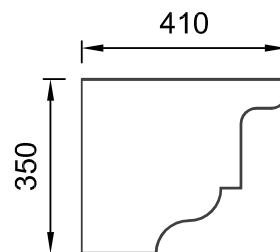

Art.Nr.: FGXCIF

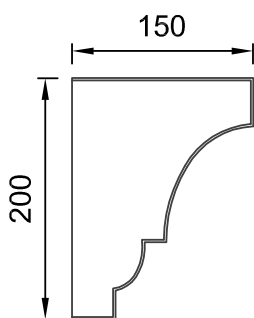

Art.Nr.: FGXCHT

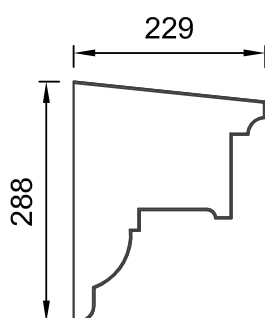

Art.Nr.: FGXCHX

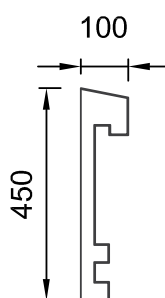

Art.Nr.: FGXCIB

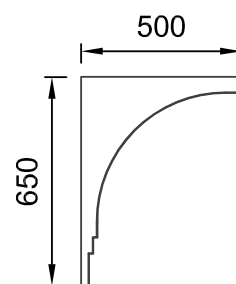

Art.Nr.: FGXCIG



QR-Code einfach scannen und
Austrotherm Materiallisten-Generator
online nutzen.

Austrotherm Gesimseprofil

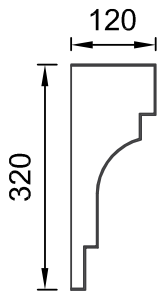

Art.Nr.: FGXCIH

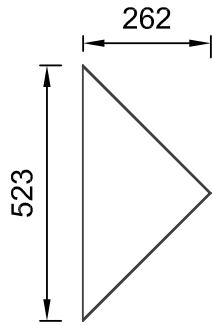

Art.Nr.: FGXCIM

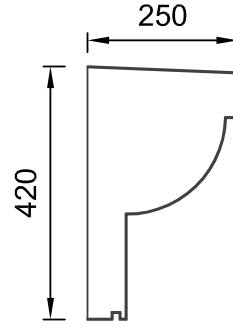

Art.Nr.: FGXCIR

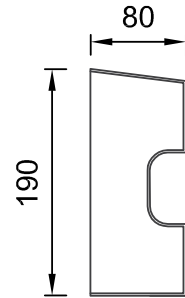

Art.Nr.: FGXCIV

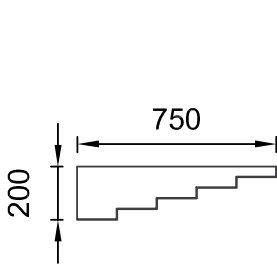

Art.Nr.: FGXCII

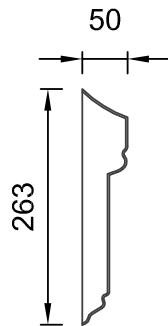

Art.Nr.: FGXCIN

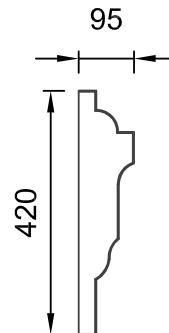

Art.Nr.: FGXCIS

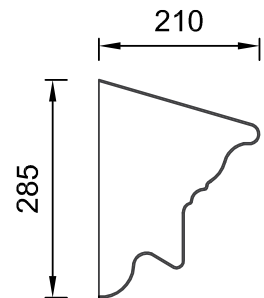

Art.Nr.: FGXCIV

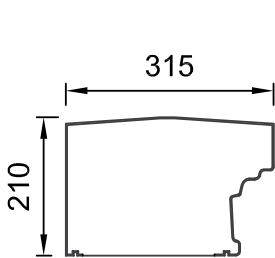

Art.Nr.: FGXCIIK

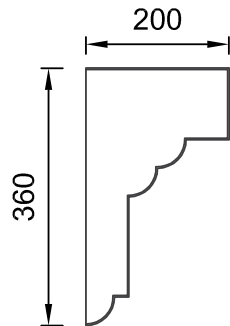

Art.Nr.: FGXCIO

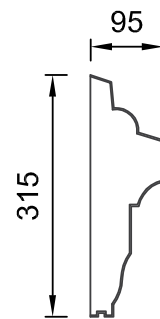

Art.Nr.: FGXCIT

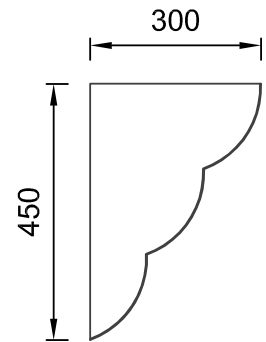

Art.Nr.: FGXCIX

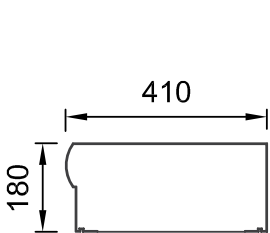

Art.Nr.: FGXCIL

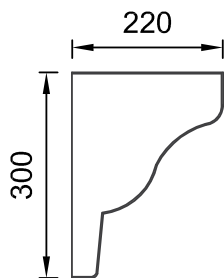

Art.Nr.: FGXCIIQ

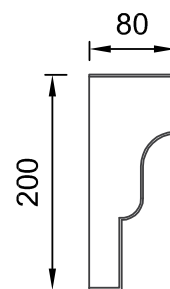

Art.Nr.: FGXCIIU

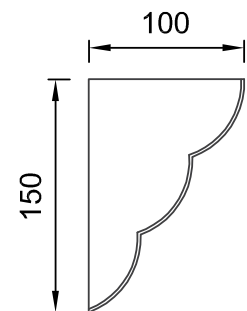

Art.Nr.: FGXCIIY



QR-Code einfach scannen und
Austrotherm Materiallisten-Generator
online nutzen.

Austrotherm Gesimseprofil

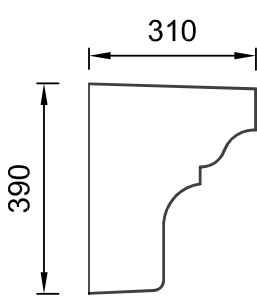

Art.Nr.: FGXCIZ

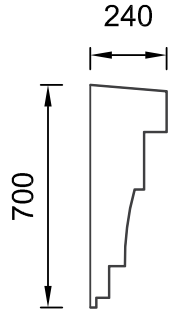

Art.Nr.: FGXCJD

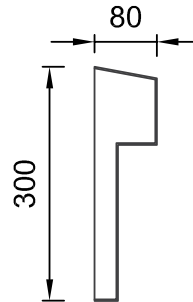

Art.Nr.: FGXCJH

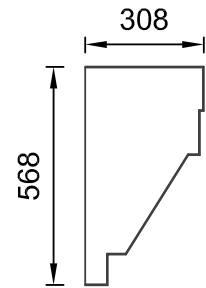

Art.Nr.: FGXCJL

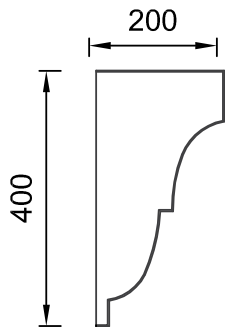

Art.Nr.: FGXCJA

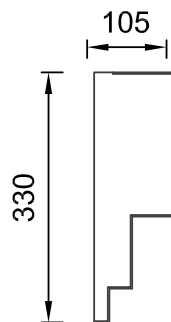

Art.Nr.: FGXCJE

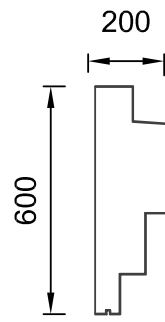

Art.Nr.: FGXCJI

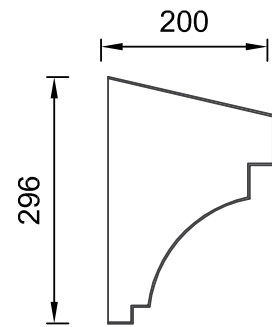

Art.Nr.: FGXCJM

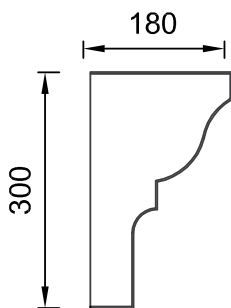

Art.Nr.: FGXCJB

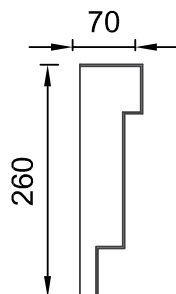

Art.Nr.: FGXCJF

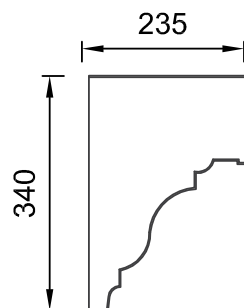

Art.Nr.: FGXCJJ

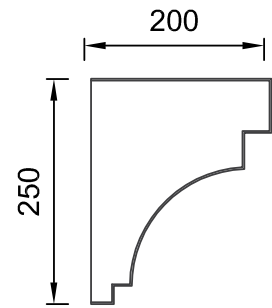

Art.Nr.: FGXCJN

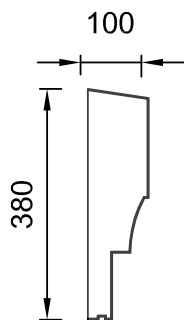

Art.Nr.: FGXCJC

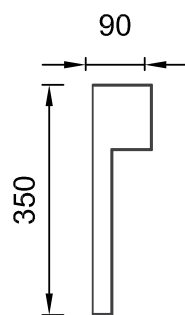

Art.Nr.: FGXCJG

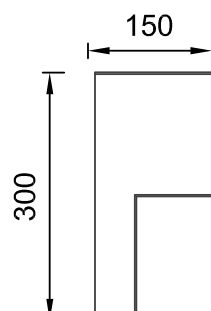

Art.Nr.: FGXCJK

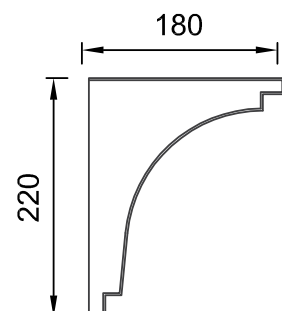

Art.Nr.: FGXCJO



QR-Code einfach scannen und
Austrotherm Materiallisten-Generator
online nutzen.

Austrotherm Gesimseprofil

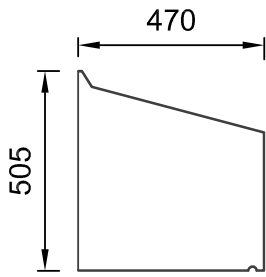

Art.Nr.: FGXCJP

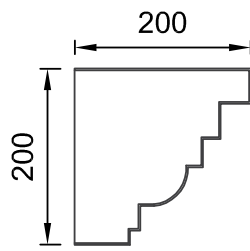

Art.Nr.: FGXCJT

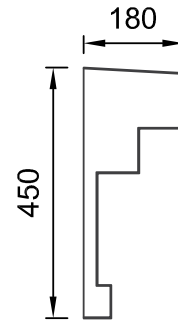

Art.Nr.: FGXCJX

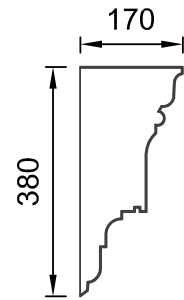

Art.Nr.: FGXCKE

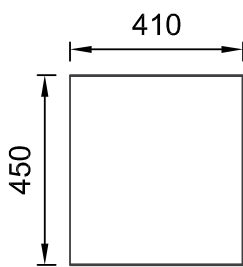

Art.Nr.: FGXCJQ

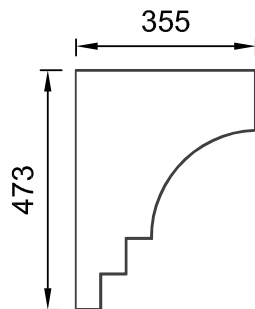

Art.Nr.: FGXCJU

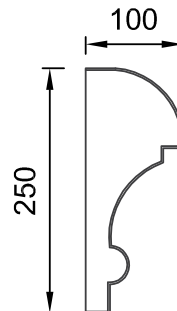

Art.Nr.: FGXCJY

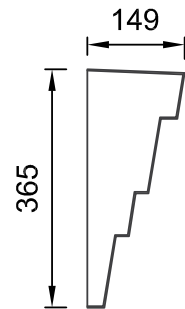

Art.Nr.: FGXCKG

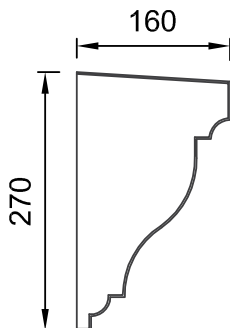

Art.Nr.: FGXCJR

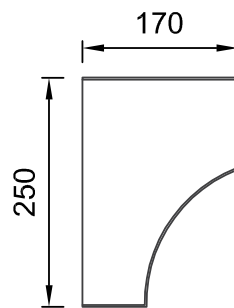

Art.Nr.: FGXCJV

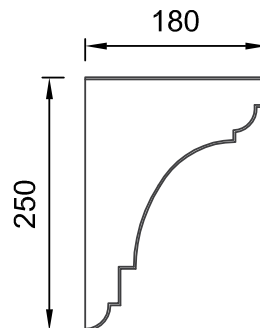

Art.Nr.: FGXCKC

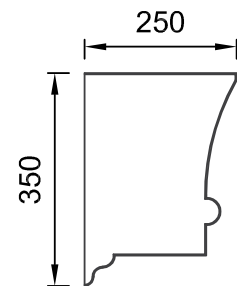

Art.Nr.: FGXCKH

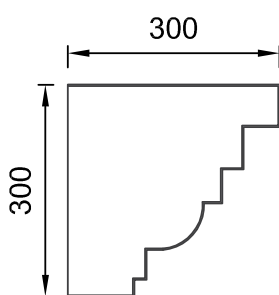

Art.Nr.: FGXCJS

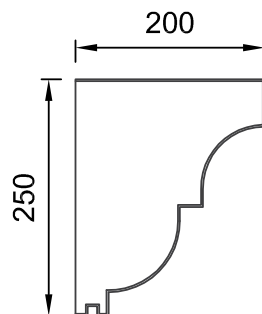

Art.Nr.: FGXCJW

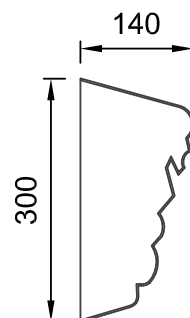

Art.Nr.: FGXCKD

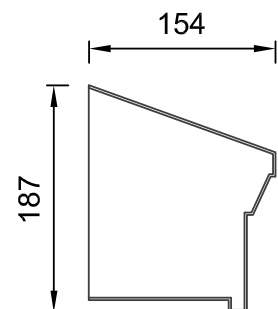

Art.Nr.: FGXCKI



QR-Code einfach scannen und
Austrotherm Materiallisten-Generator
online nutzen.

Austrotherm Gesimseprofil

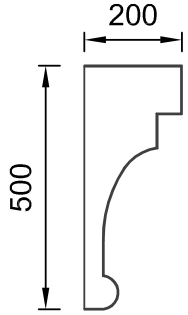

Art.Nr.: FGXCKJ

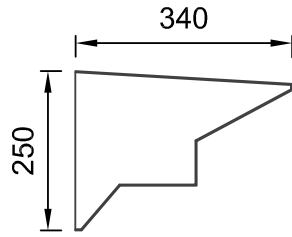

Art.Nr.: FGXCKN

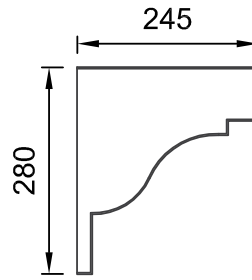

Art.Nr.: FGXCKT

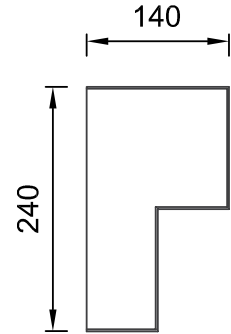

Art.Nr.: FGXCKX

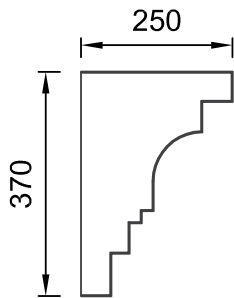

Art.Nr.: FGXCKK

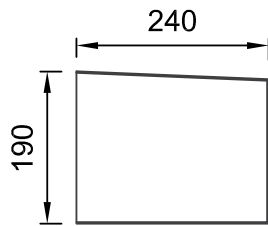

Art.Nr.: FGXCKO

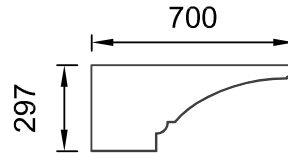

Art.Nr.: FGXCKU

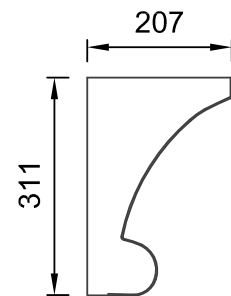

Art.Nr.: FGXCKY

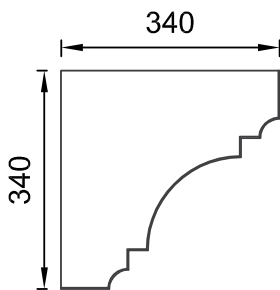

Art.Nr.: FGXCKL

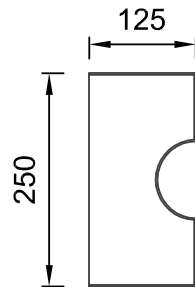

Art.Nr.: FGXCKP

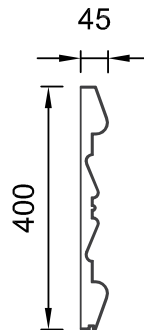

Art.Nr.: FGXCKV

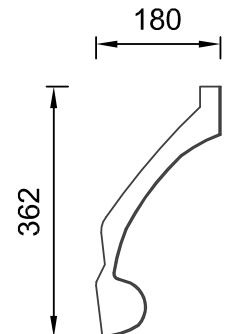

Art.Nr.: FGXCKZ

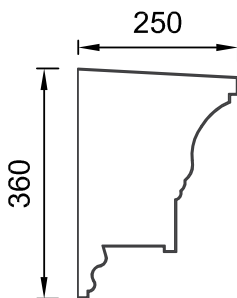

Art.Nr.: FGXCKM

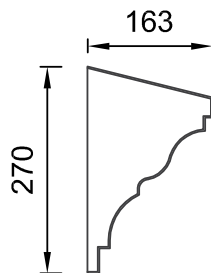

Art.Nr.: FGXCKS

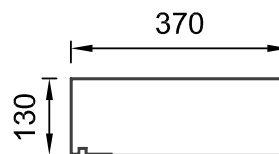

Art.Nr.: FGXCKW

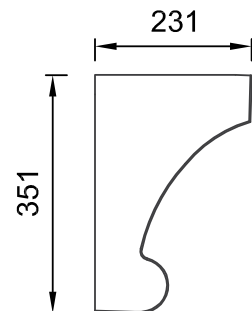

Art.Nr.: FGXCLA



QR-Code einfach scannen und
Austrotherm Materiallisten-Generator
online nutzen.

Austrotherm Gesimseprofil

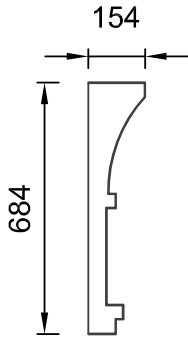

Art.Nr.: FGXCLB

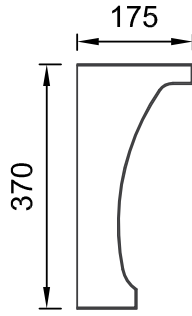

Art.Nr.: FGXCLH

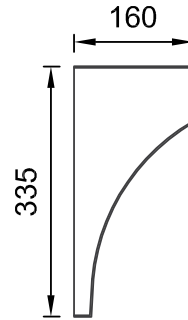

Art.Nr.: FGXCLM

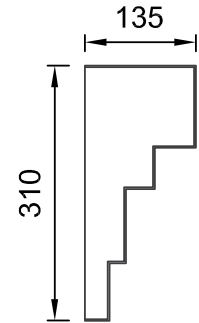

Art.Nr.: FGXCLQ

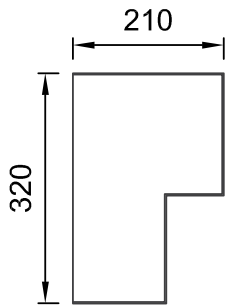

Art.Nr.: FGXCLC

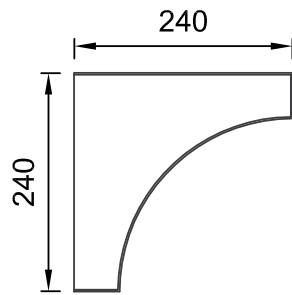

Art.Nr.: FGXCLI

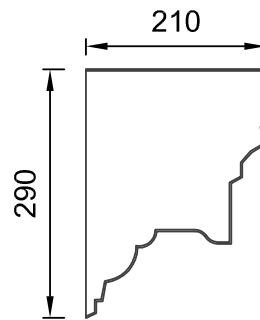

Art.Nr.: FGXCLN

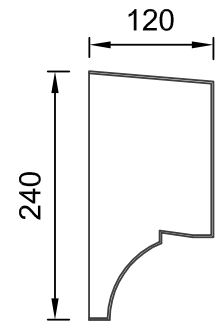

Art.Nr.: FGXCLR

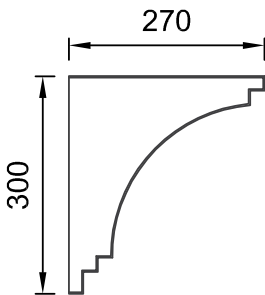

Art.Nr.: FGXCLF

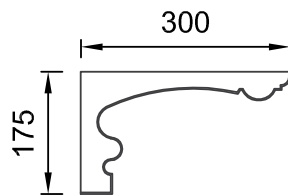

Art.Nr.: FGXCLJ

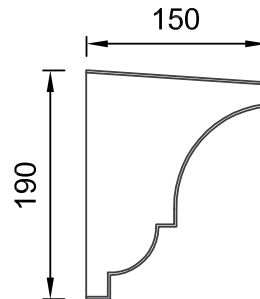

Art.Nr.: FGXCLO

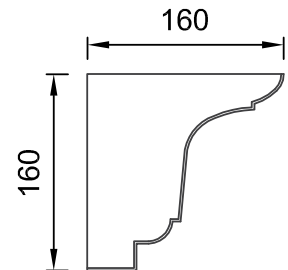

Art.Nr.: FGXCLT

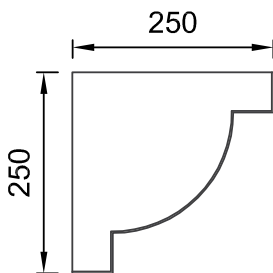

Art.Nr.: FGXCLG

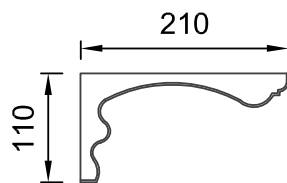

Art.Nr.: FGXCLK

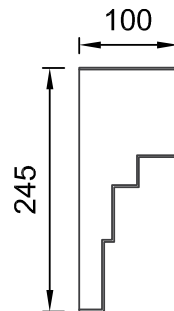

Art.Nr.: FGXCLP

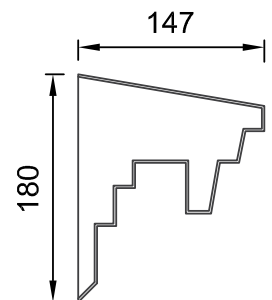

Art.Nr.: FGXCLU



QR-Code einfach scannen und
Austrotherm Materiallisten-Generator
online nutzen.

Austrotherm Gesimseprofil

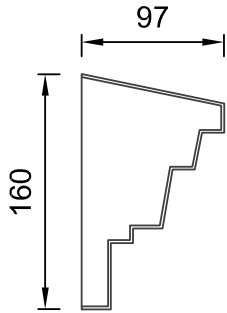

Art.Nr.: FGXCLV

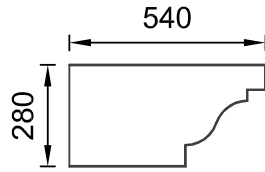

Art.Nr.: FGXCMB

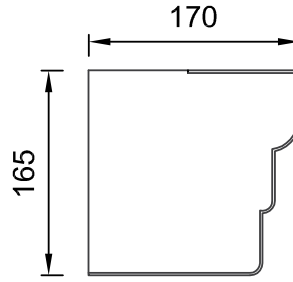

Art.Nr.: FGXCMH

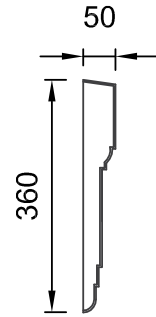

Art.Nr.: FGXCML

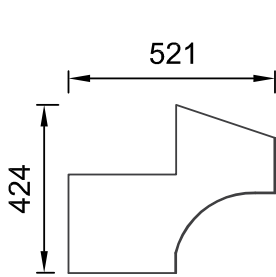

Art.Nr.: FGXCLW

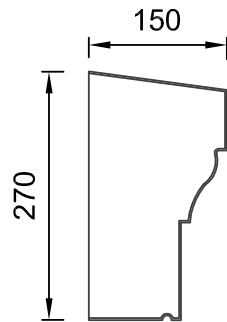

Art.Nr.: FGXCMC

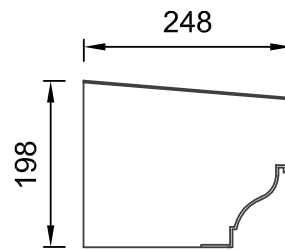

Art.Nr.: FGXCMI

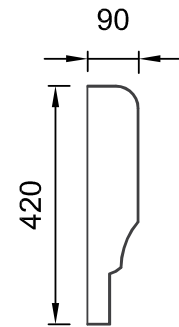

Art.Nr.: FGXCMM

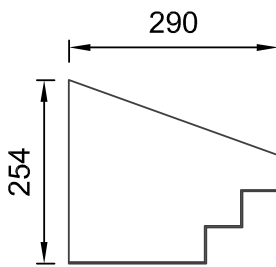

Art.Nr.: FGXCLY

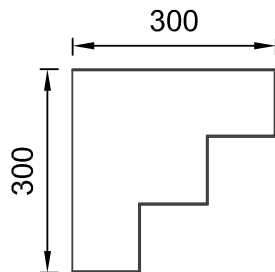

Art.Nr.: FGXCMF

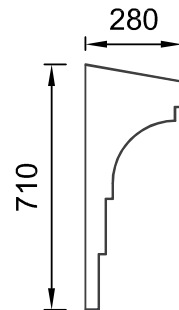

Art.Nr.: FGXCMJ

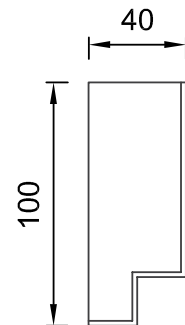

Art.Nr.: FGXCMN

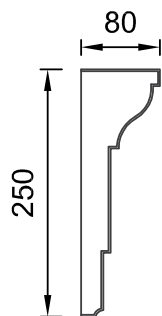

Art.Nr.: FGXCMA

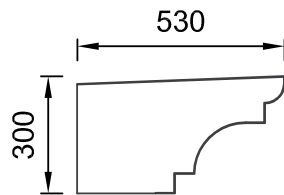

Art.Nr.: FGXCMG

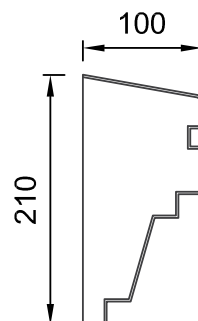

Art.Nr.: FGXCMK

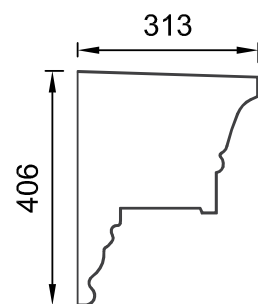

Art.Nr.: FGXCME



QR-Code einfach scannen und
Austrotherm Materiallisten-Generator
online nutzen.

Austrotherm Gesimseprofil

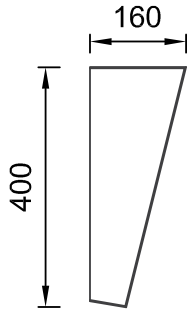

Art.Nr.: FGXCMP

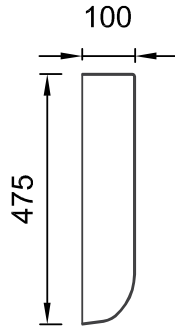

Art.Nr.: FGXCMU

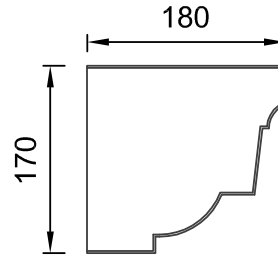

Art.Nr.: FGXCMY

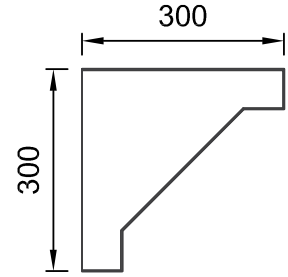

Art.Nr.: FGXCNC

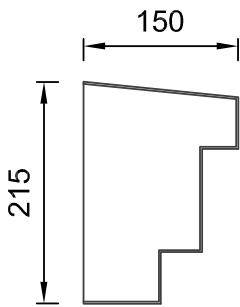

Art.Nr.: FGXCMR

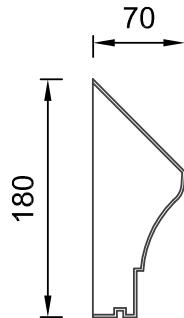

Art.Nr.: FGXCMV

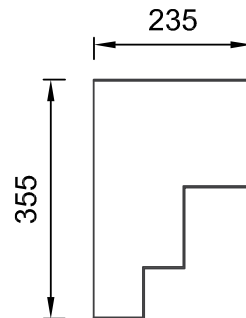

Art.Nr.: FGXCMZ

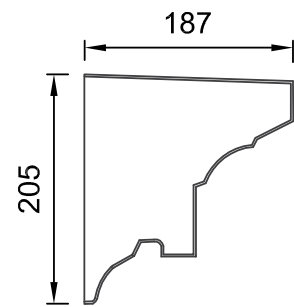

Art.Nr.: FGXCND

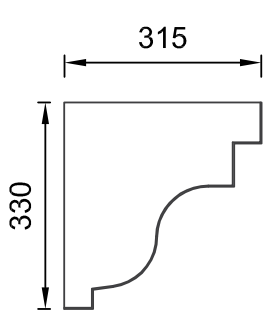

Art.Nr.: FGXCMS

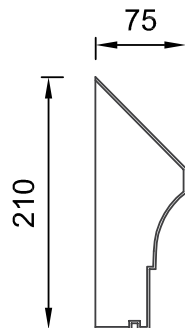

Art.Nr.: FGXCMW

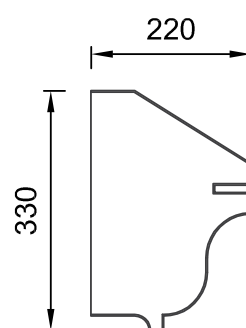

Art.Nr.: FGXCNA

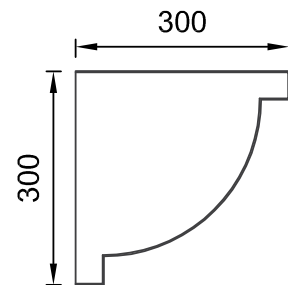

Art.Nr.: FGXCNE

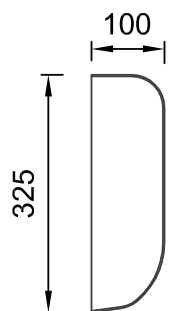

Art.Nr.: FGXCMT

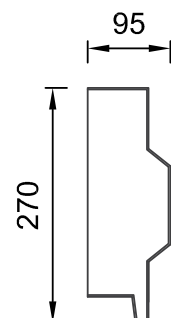

Art.Nr.: FGXCMX

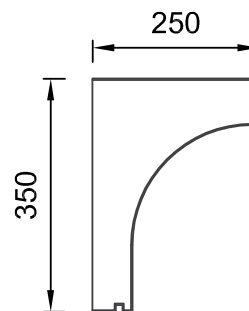

Art.Nr.: FGXCNB

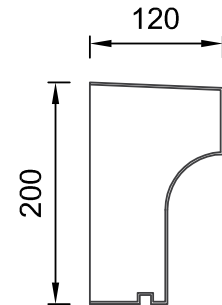

Art.Nr.: FGXCNF



QR-Code einfach scannen und
Austrotherm Materiallisten-Generator
online nutzen.

Austrotherm Gesimseprofil

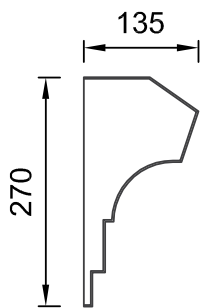

Art.Nr.: FGXCNG

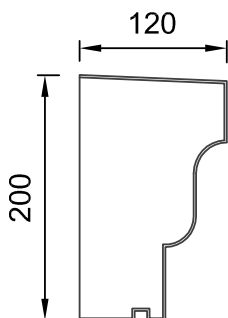

Art.Nr.: FGXCNK

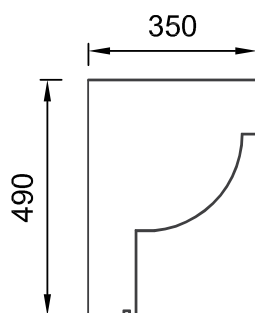

Art.Nr.: FGXCNO

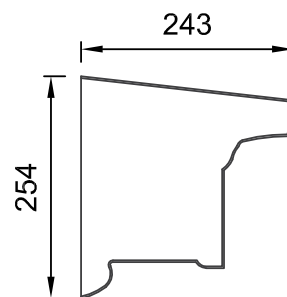

Art.Nr.: FGXCNS

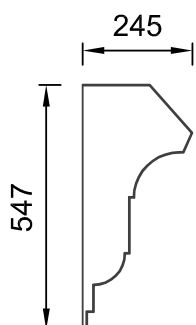

Art.Nr.: FGXCNH

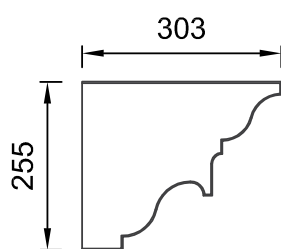

Art.Nr.: FGXCNL

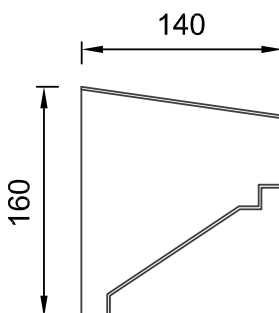

Art.Nr.: FGXCNP

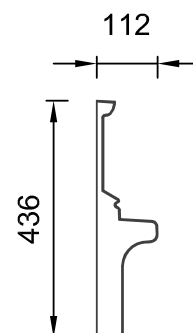

Art.Nr.: FGXCNT

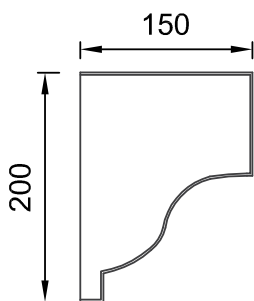

Art.Nr.: FGXCNI

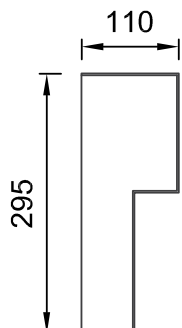

Art.Nr.: FGXCNM

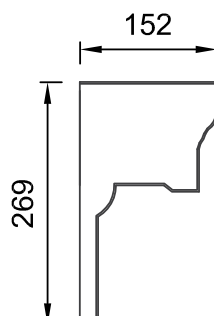

Art.Nr.: FGXCNQ

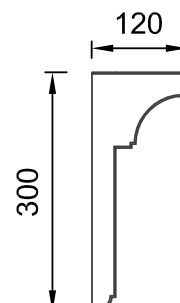

Art.Nr.: FGXCNU

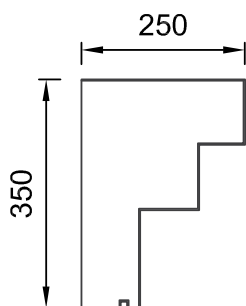

Art.Nr.: FGXCNJ

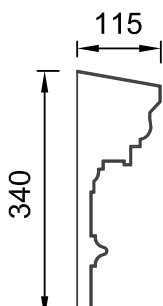

Art.Nr.: FGXCNN

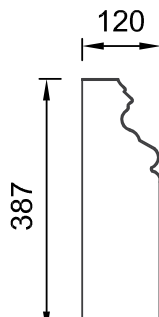

Art.Nr.: FGXCNR

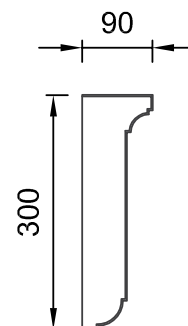

Art.Nr.: FGXCNV



QR-Code einfach scannen und
Austrotherm Materiallisten-Generator
online nutzen.

Austrotherm Gesimseprofil

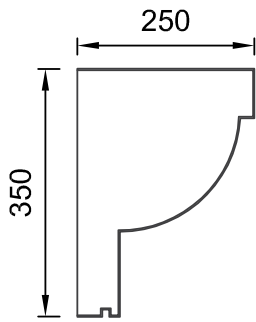

Art.Nr.: FGXCNW

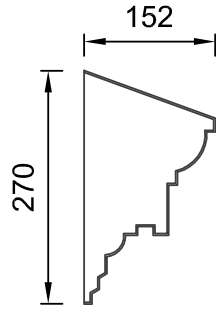

Art.Nr.: FGXCOA

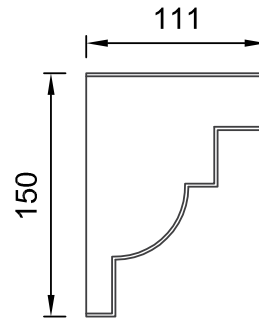

Art.Nr.: FGXCOF

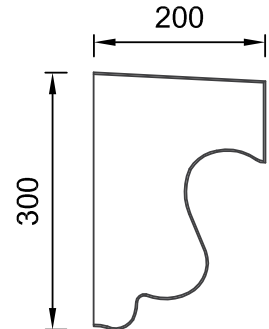

Art.Nr.: FGXCOJ

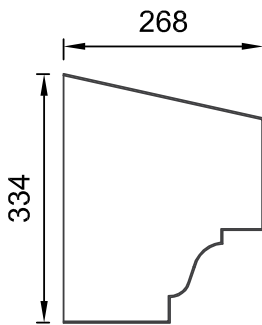

Art.Nr.: FGXCNX

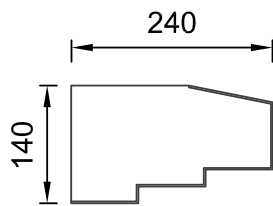

Art.Nr.: FGXCOB

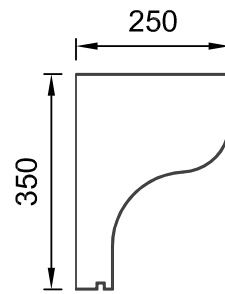

Art.Nr.: FGXCOG

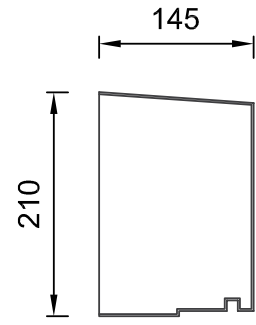

Art.Nr.: FGXCOK

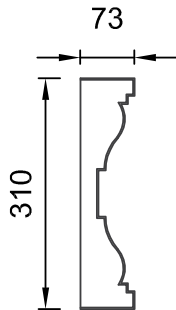

Art.Nr.: FGXCNY

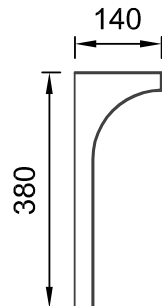

Art.Nr.: FGXCOC

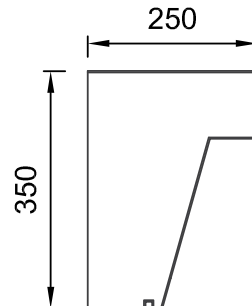

Art.Nr.: FGXCOH

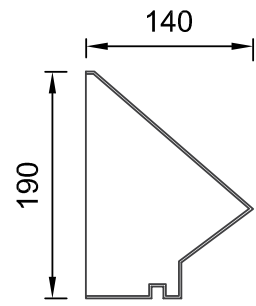

Art.Nr.: FGXCOL

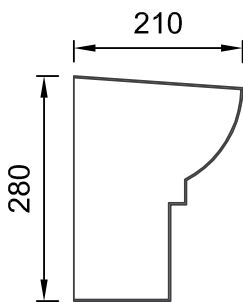

Art.Nr.: FGXCNZ

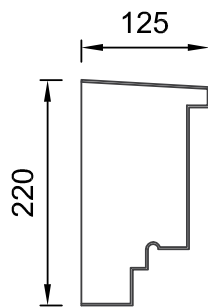

Art.Nr.: FGXCOE

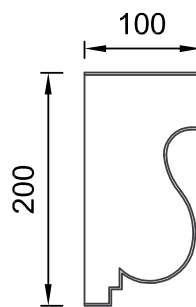

Art.Nr.: FGXCOI

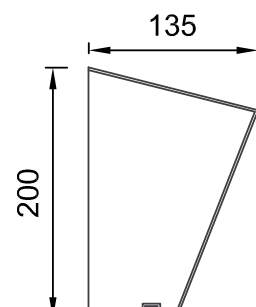

Art.Nr.: FGXCOM



QR-Code einfach scannen und
Austrotherm Materiallisten-Generator
online nutzen.

Austrotherm Gesimseprofil

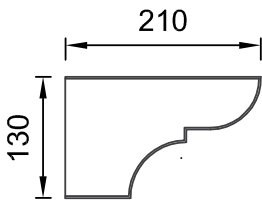

Art.Nr.: FGXCONE

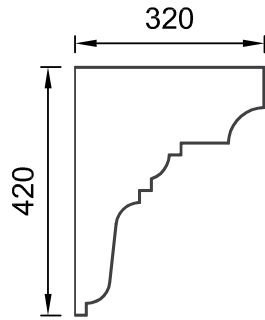

Art.Nr.: FGXCOR

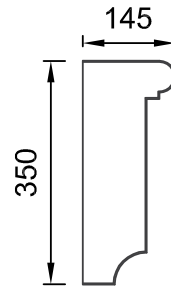

Art.Nr.: FGXCOW

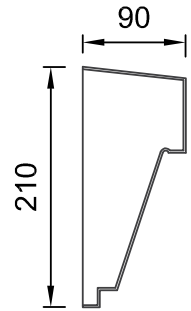

Art.Nr.: FGXCOZ

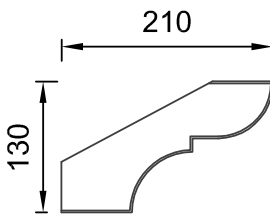

Art.Nr.: FGXCOO

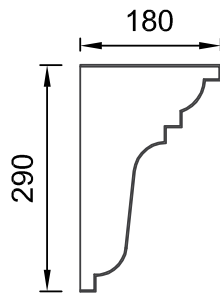

Art.Nr.: FGXCOS

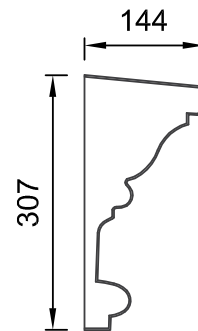

Art.Nr.: FGXCOW

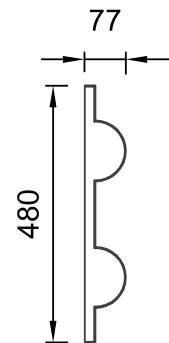

Art.Nr.: FGXCPA

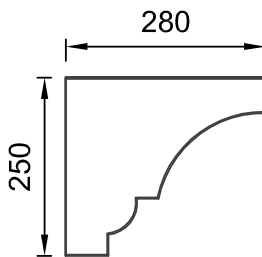

Art.Nr.: FGXCOP

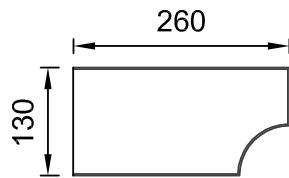

Art.Nr.: FGXCOT

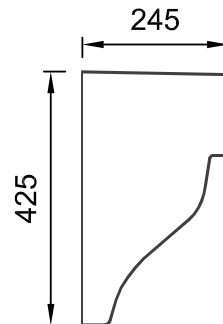

Art.Nr.: FGXCOW

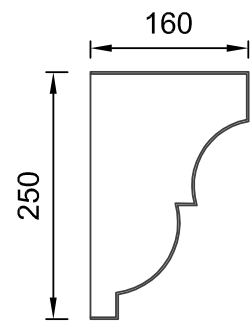

Art.Nr.: FGXCPB

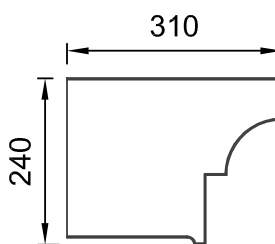

Art.Nr.: FGXCOQ

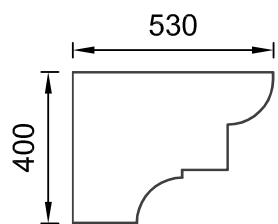

Art.Nr.: FGXCOW

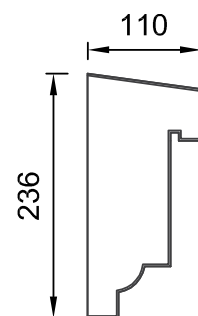

Art.Nr.: FGXCOW

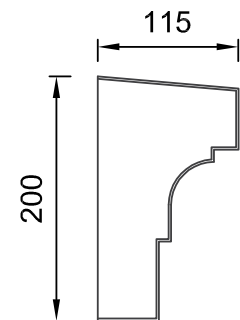

Art.Nr.: FGXCPC



QR-Code einfach scannen und
Austrotherm Materiallisten-Generator
online nutzen.

Austrotherm Gesimseprofil

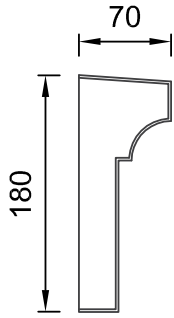

Art.Nr.: FGXCPD

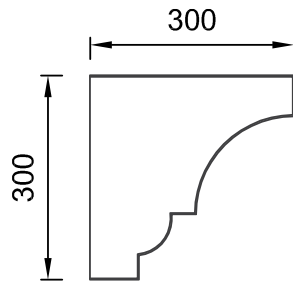

Art.Nr.: FGXCPH

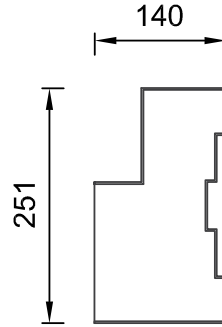

Art.Nr.: FGXCPL

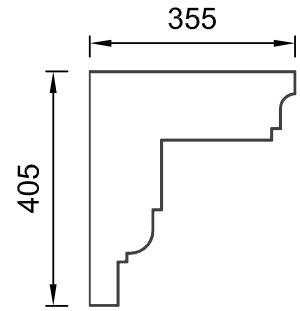

Art.Nr.: FGXCPP

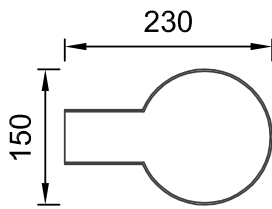

Art.Nr.: FGXCPE

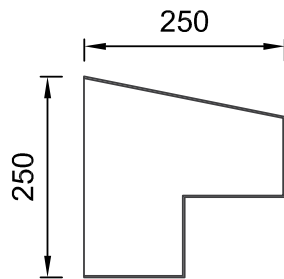

Art.Nr.: FGXCPI

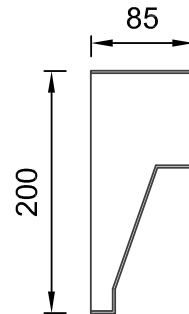

Art.Nr.: FGXCPL

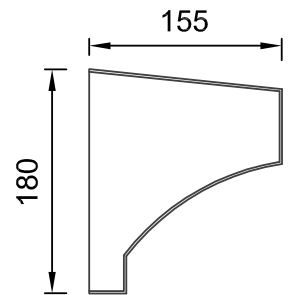

Art.Nr.: FGXCPO

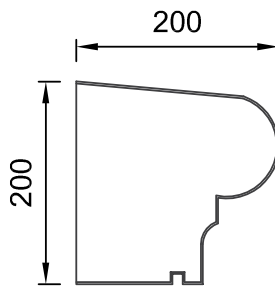

Art.Nr.: FGXCPL

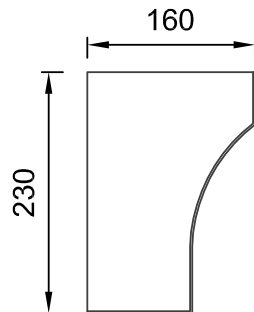

Art.Nr.: FGXCPL

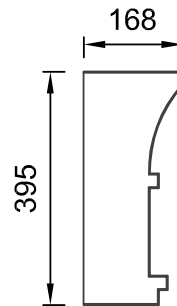

Art.Nr.: FGXCPL

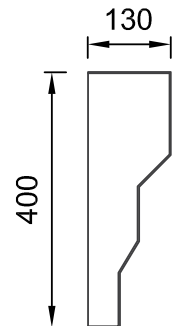

Art.Nr.: FGXCPL

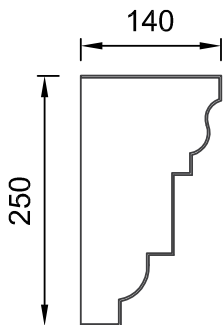

Art.Nr.: FGXCPL

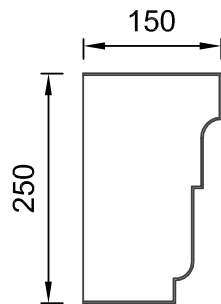

Art.Nr.: FGXCPL

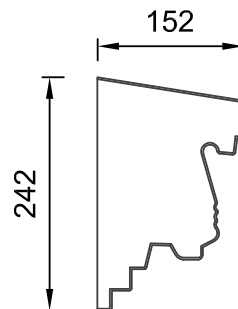

Art.Nr.: FGXCPL

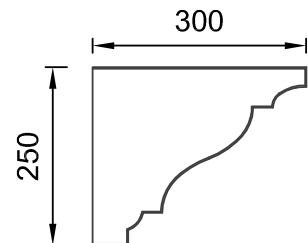

Art.Nr.: FGXCPL



QR-Code einfach scannen und
Austrotherm Materiallisten-Generator
online nutzen.

Austrotherm Gesimseprofil

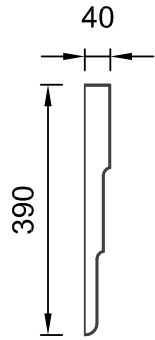

Art.Nr.: FGXCPT

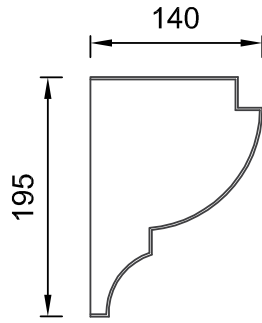

Art.Nr.: FGXCPX

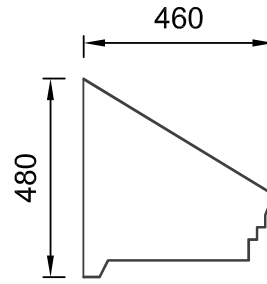

Art.Nr.: FGXCQB

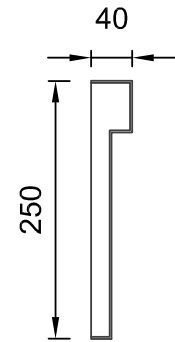

Art.Nr.: FGXCQF

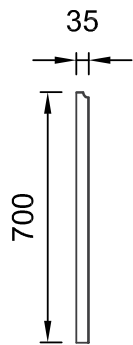

Art.Nr.: FGXCPU

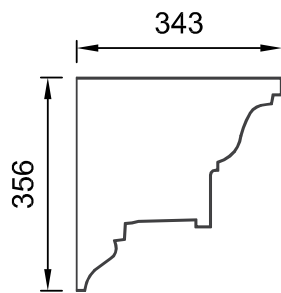

Art.Nr.: FGXCPY

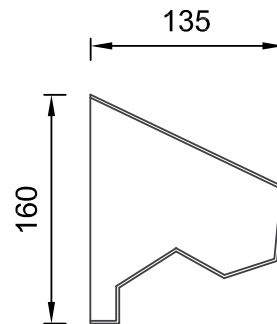

Art.Nr.: FGXCQC

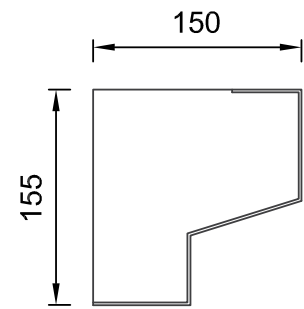

Art.Nr.: FGXCQG

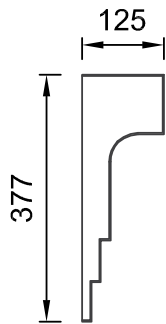

Art.Nr.: FGXCPV

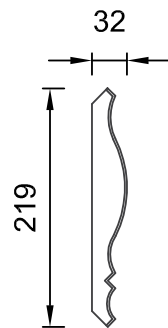

Art.Nr.: FGXCPZ

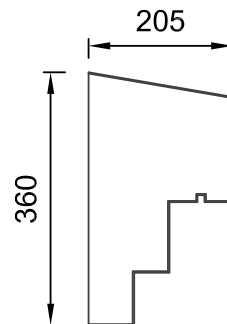

Art.Nr.: FGXCQD

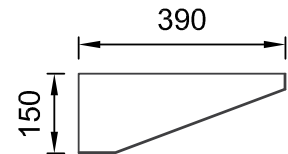

Art.Nr.: FGXCQH

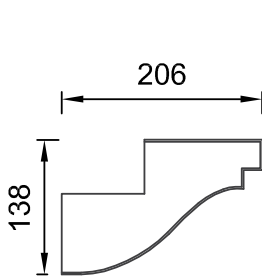

Art.Nr.: FGXCPW

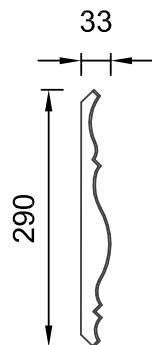

Art.Nr.: FGXCQA

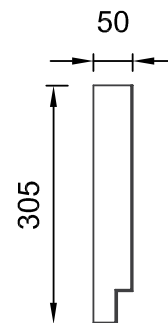

Art.Nr.: FGXCQE

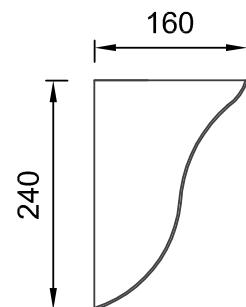

Art.Nr.: FGXCQI



QR-Code einfach scannen und
Austrotherm Materiallisten-Generator
online nutzen.

Austrotherm Gesimseprofil

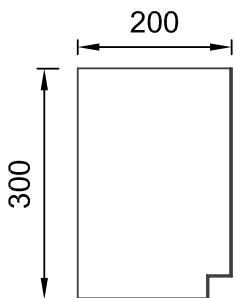

Art.Nr.: FGXCQJ

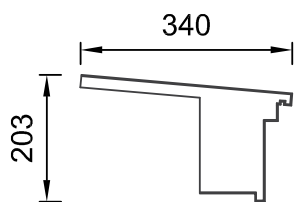

Art.Nr.: FGXCQN

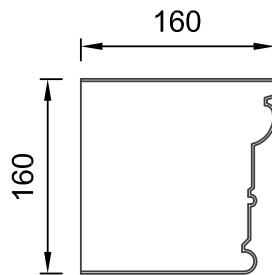

Art.Nr.: FGXCQR

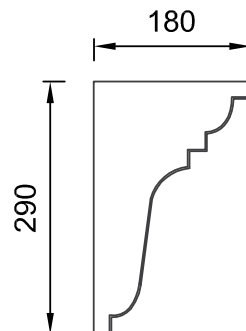

Art.Nr.: FGXCQV

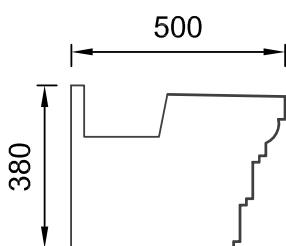

Art.Nr.: FGXCQK

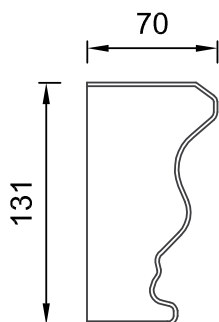

Art.Nr.: FGXCQO

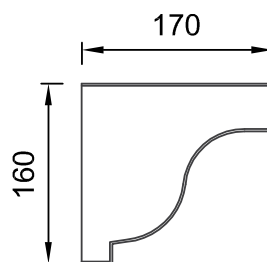

Art.Nr.: FGXCQS

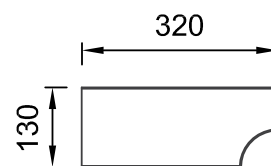

Art.Nr.: FGXCQW

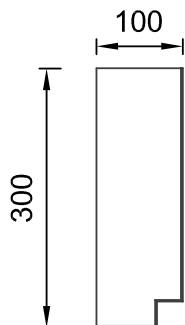

Art.Nr.: FGXCQL

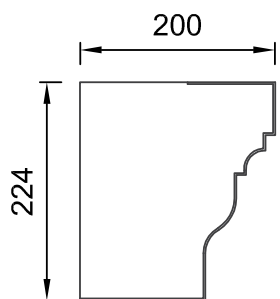

Art.Nr.: FGXCQP

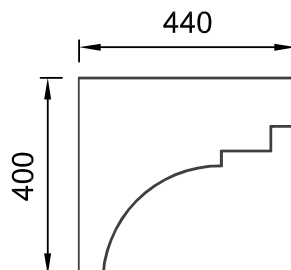

Art.Nr.: FGXCQT

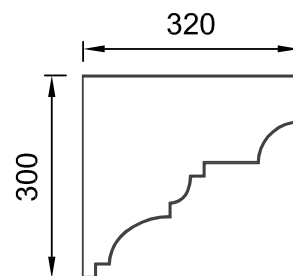

Art.Nr.: FGXCQX

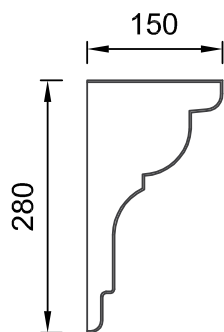

Art.Nr.: FGXCQM

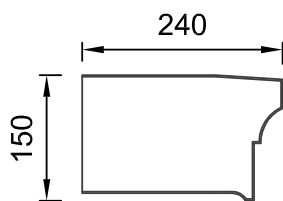

Art.Nr.: FGXCQQ

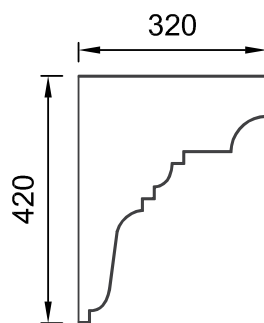

Art.Nr.: FGXCQU

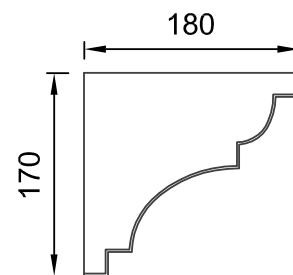

Art.Nr.: FGXCQY



QR-Code einfach scannen und
Austrotherm Materiallisten-Generator
online nutzen.

Austrotherm Gesimseprofil

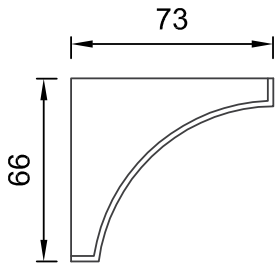

Art.Nr.: FGXCQZ

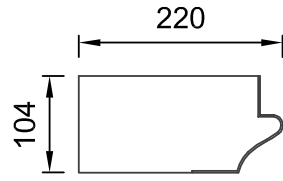

Art.Nr.: FGXCRD

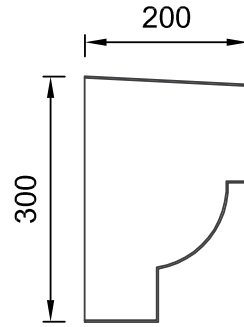

Art.Nr.: FGXCRH

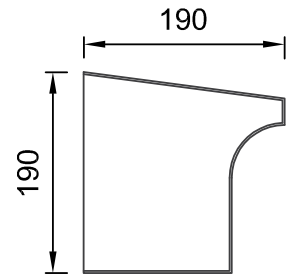

Art.Nr.: FGXCRL

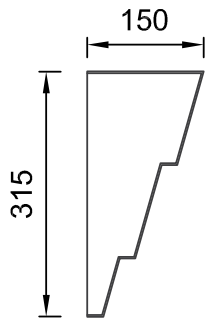

Art.Nr.: FGXCRA

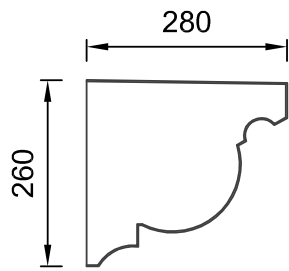

Art.Nr.: FGXCRE

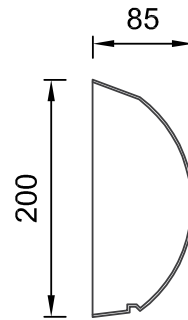

Art.Nr.: FGXCRI

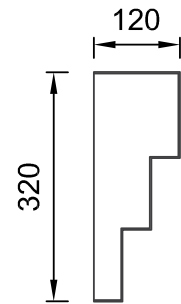

Art.Nr.: FGXCRM

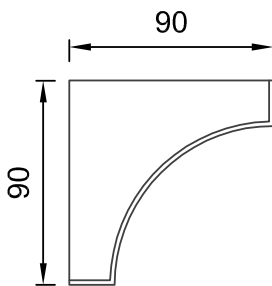

Art.Nr.: FGXCRB

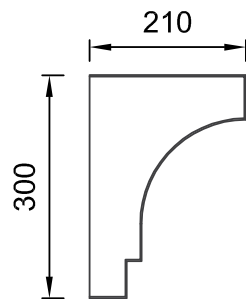

Art.Nr.: FGXCRF

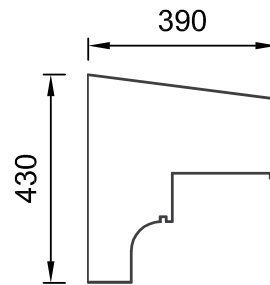

Art.Nr.: FGXCRJ

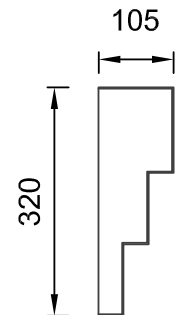

Art.Nr.: FGXCRN

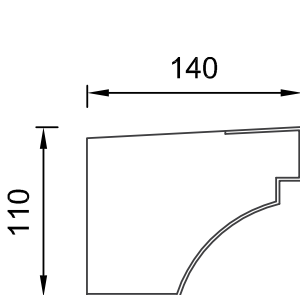

Art.Nr.: FGXCRC

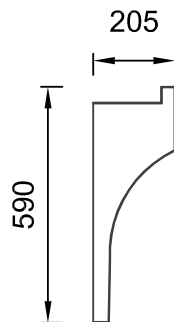

Art.Nr.: FGXCRG

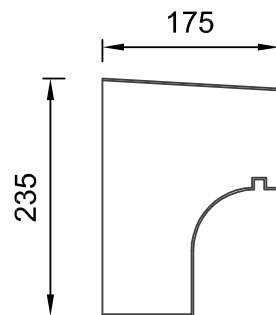

Art.Nr.: FGXCRK

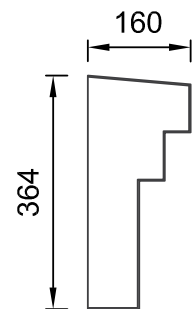

Art.Nr.: FGXCRO



QR-Code einfach scannen und
Austrotherm Materiallisten-Generator
online nutzen.

Austrotherm Gesimseprofil

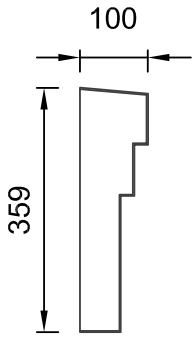

Art.Nr.: FGXCRP

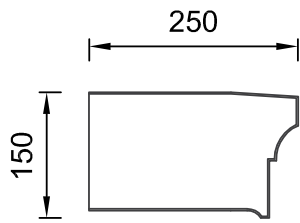

Art.Nr.: FGXCRT

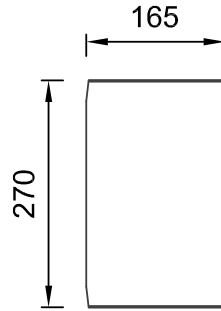

Art.Nr.: FGXCRX

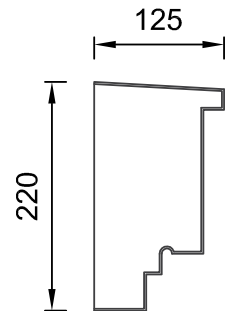

Art.Nr.: FGXCSC

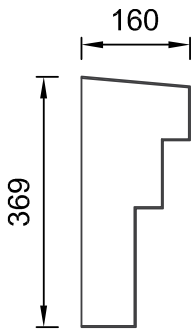

Art.Nr.: FGXCRQ

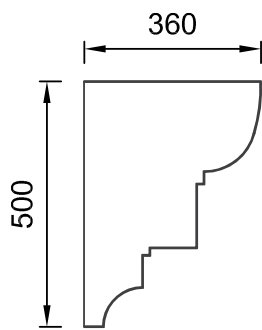

Art.Nr.: FGXCRU

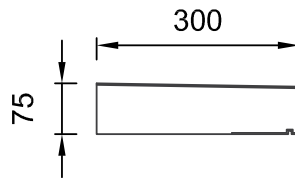

Art.Nr.: FGXCRZ

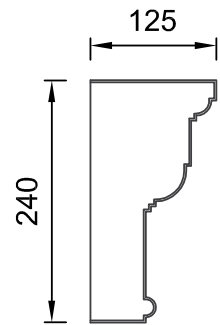

Art.Nr.: FGXCSD

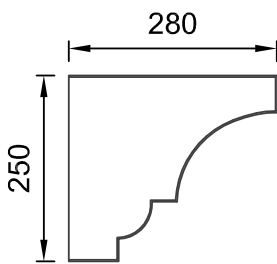

Art.Nr.: FGXCRR

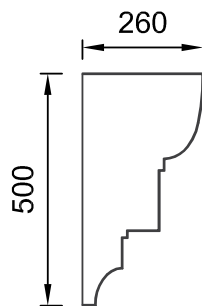

Art.Nr.: FGXCRV

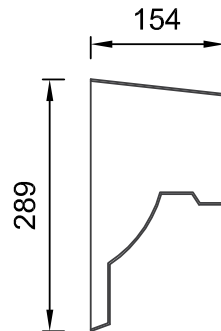

Art.Nr.: FGXCSEA

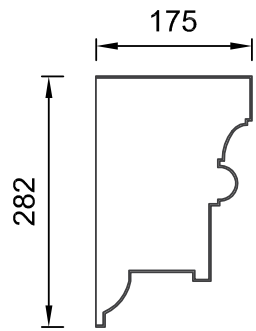

Art.Nr.: FGXCSEB

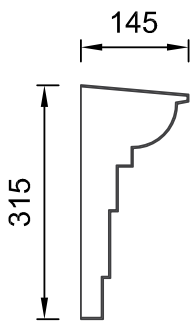

Art.Nr.: FGXCRES

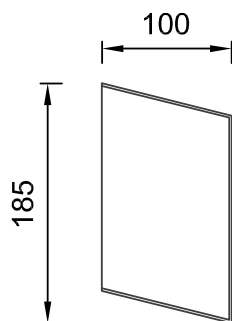

Art.Nr.: FGXCRW

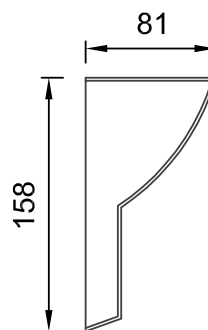

Art.Nr.: FGXCSEB

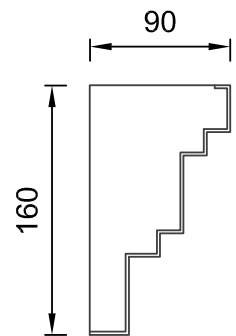

Art.Nr.: FGXCSEF



QR-Code einfach scannen und
Austrotherm Materiallisten-Generator
online nutzen.

Austrotherm Gesimseprofil

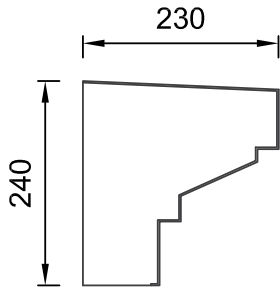

Art.Nr.: FGXCSCG

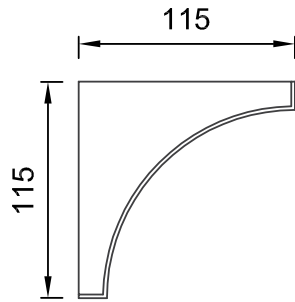

Art.Nr.: FGXCCK

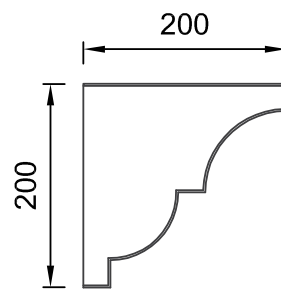

Art.Nr.: FGXCSC

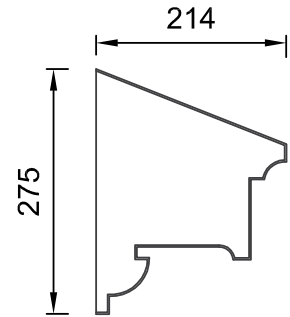

Art.Nr.: FGXCSCS

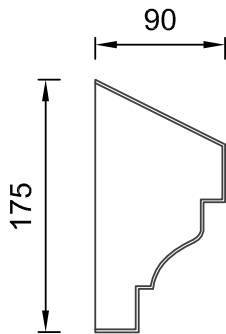

Art.Nr.: FGXCSCSH

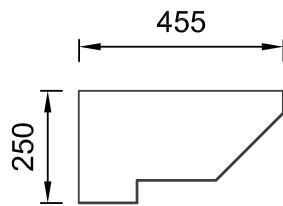

Art.Nr.: FGXCSSL

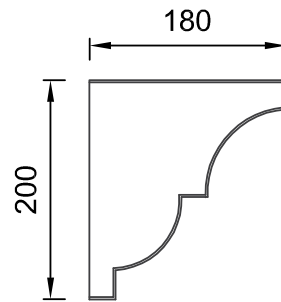

Art.Nr.: FGXCSCP

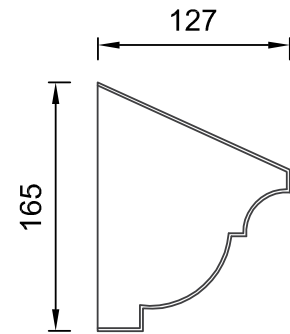

Art.Nr.: FGXCSCST

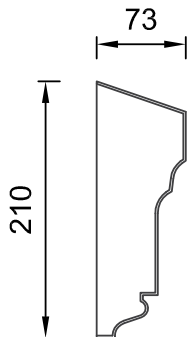

Art.Nr.: FGXCSCI

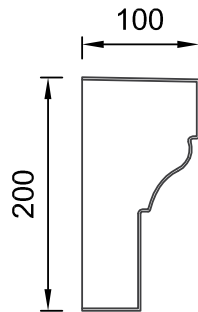

Art.Nr.: FGXCSCM

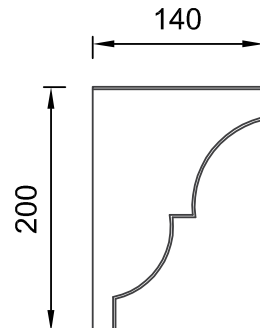

Art.Nr.: FGXCSCQ

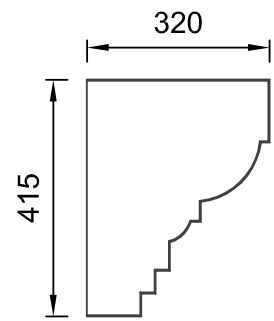

Art.Nr.: FGXCSCSU

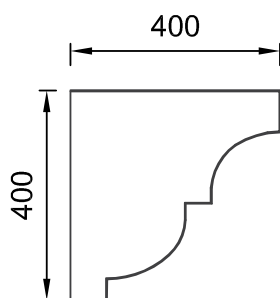

Art.Nr.: FGXCSCJ

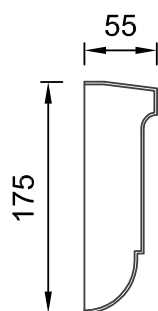

Art.Nr.: FGXCSCN

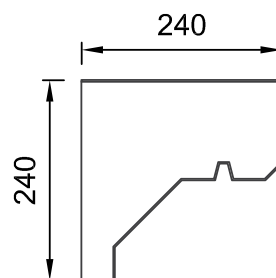

Art.Nr.: FGXCSCR

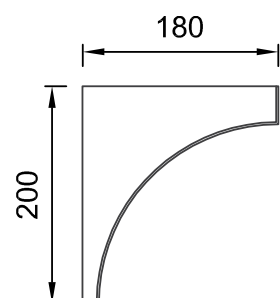

Art.Nr.: FGXCSCSV



QR-Code einfach scannen und
Austrotherm Materiallisten-Generator
online nutzen.

Austrotherm Gesimseprofil

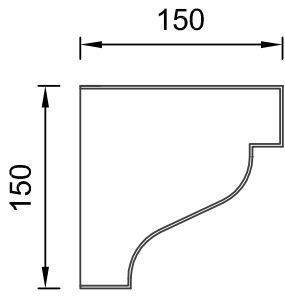

Art.Nr.: FGXCSW

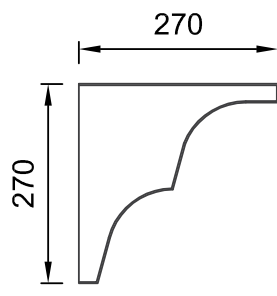

Art.Nr.: FGXCTA

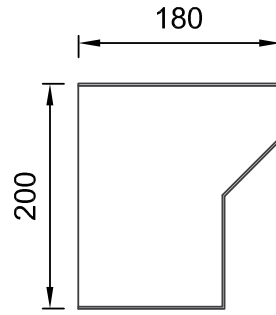

Art.Nr.: FGXCTE

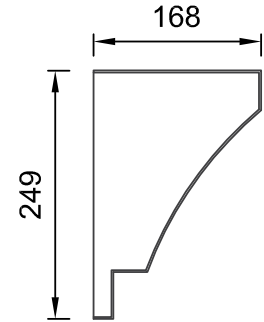

Art.Nr.: FGXCTJ

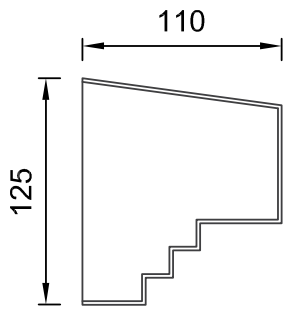

Art.Nr.: FGXCSX

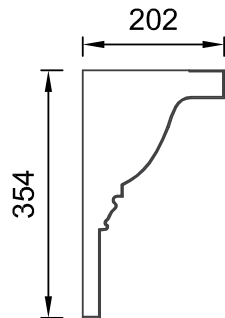

Art.Nr.: FGXCTB

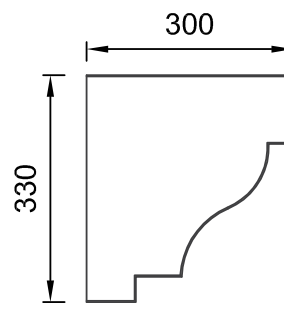

Art.Nr.: FGXCTG

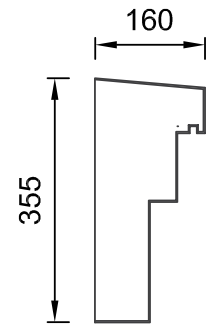

Art.Nr.: FGXCTK

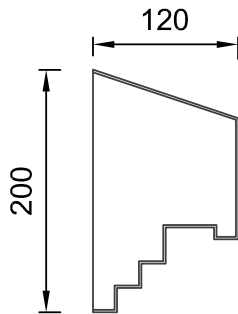

Art.Nr.: FGXCSY

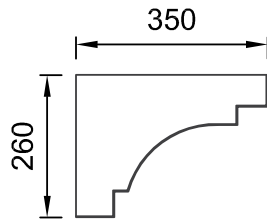

Art.Nr.: FGXCTC

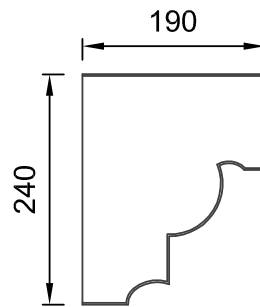

Art.Nr.: FGXCTH

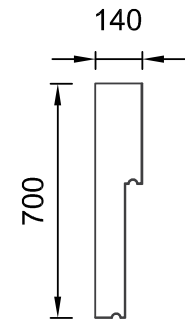

Art.Nr.: FGXCTL

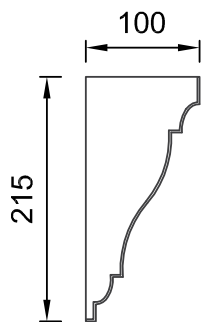

Art.Nr.: FGXCSZ

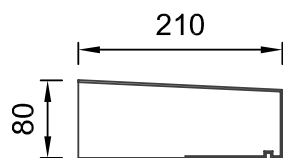

Art.Nr.: FGXCTD

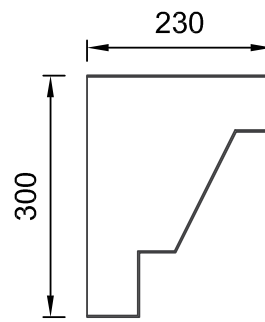

Art.Nr.: FGXCTI

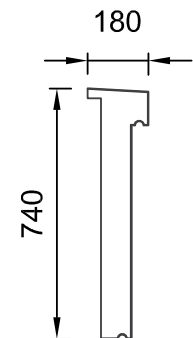

Art.Nr.: FGXCTM



QR-Code einfach scannen und
Austrotherm Materiallisten-Generator
online nutzen.

Austrotherm Gesimseprofil

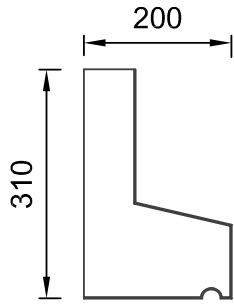

Art.Nr.: FGXCTN

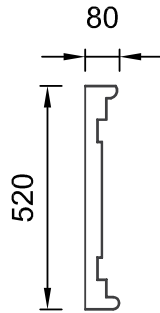

Art.Nr.: FGXCTR

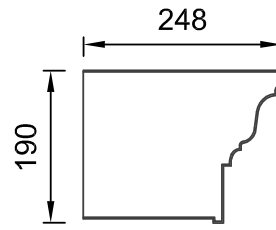

Art.Nr.: FGXCTV

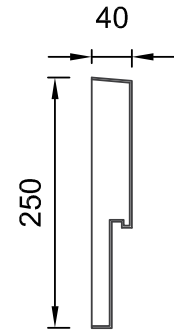

Art.Nr.: FGXCTZ

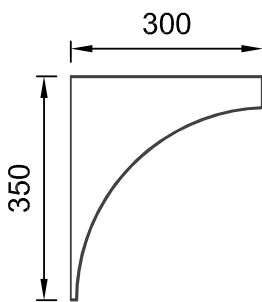

Art.Nr.: FGXCTO

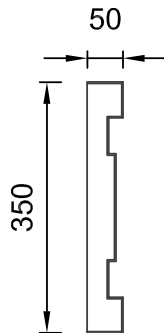

Art.Nr.: FGXCTS

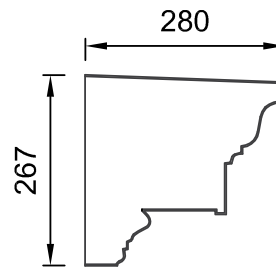

Art.Nr.: FGXCTW

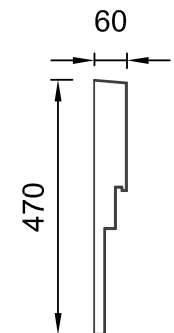

Art.Nr.: FGXCUA

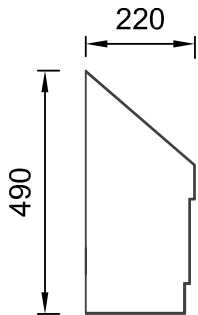

Art.Nr.: FGXCTP

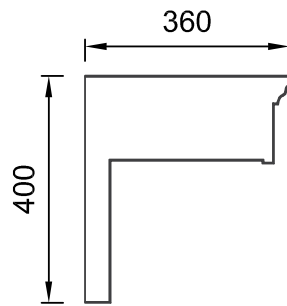

Art.Nr.: FGXCTT

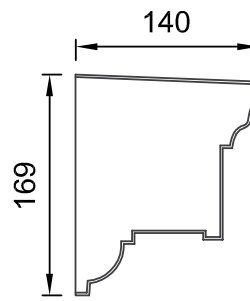

Art.Nr.: FGXCTX

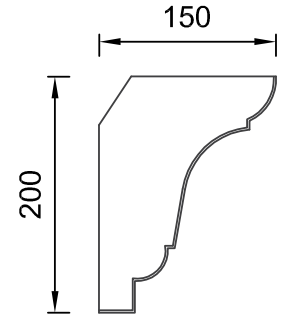

Art.Nr.: FGXCUB

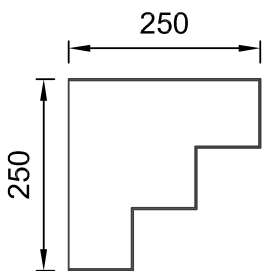

Art.Nr.: FGXCTQ

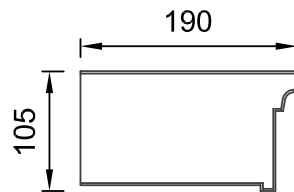

Art.Nr.: FGXCTU

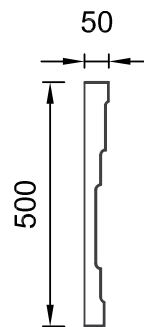

Art.Nr.: FGXCTY

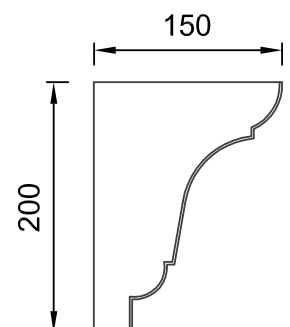

Art.Nr.: FGXCUC



QR-Code einfach scannen und
Austrotherm Materiallisten-Generator
online nutzen.

Austrotherm Gesimseprofil

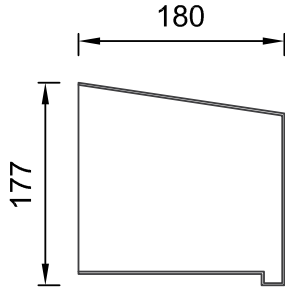

Art.Nr.: FGXCUD

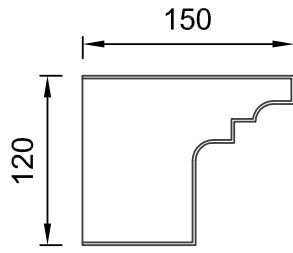

Art.Nr.: FGXCUH

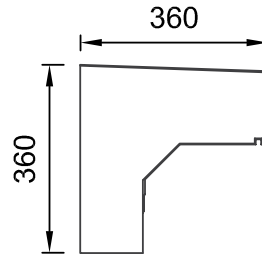

Art.Nr.: FGXCUL

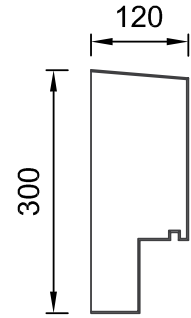

Art.Nr.: FGXCUP

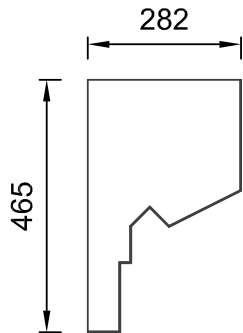

Art.Nr.: FGXCUE

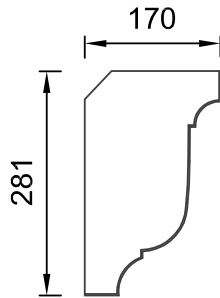

Art.Nr.: FGXCUI

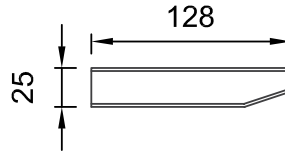

Art.Nr.: FGXCUM

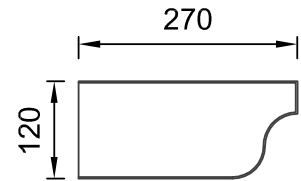

Art.Nr.: FGXCUQ

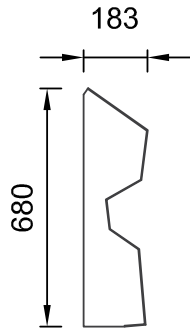

Art.Nr.: FGXCUF

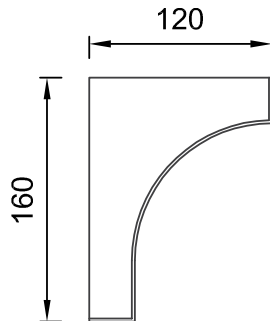

Art.Nr.: FGXCUIJ

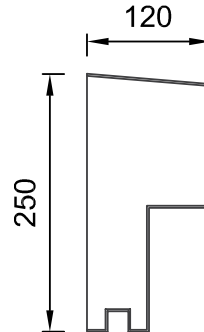

Art.Nr.: FGXCUN

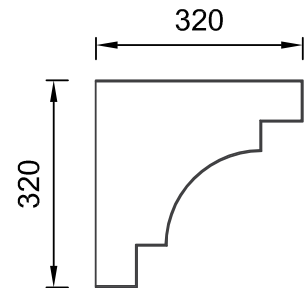

Art.Nr.: FGXCUR

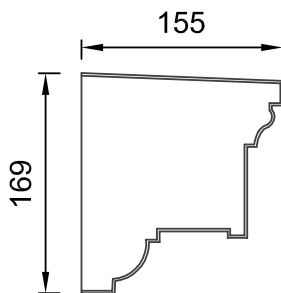

Art.Nr.: FGXCUG

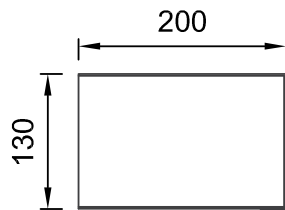

Art.Nr.: FGXCUK

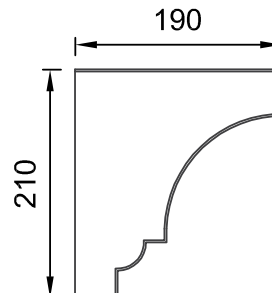

Art.Nr.: FGXCULO

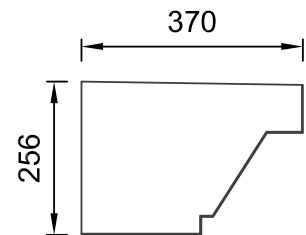

Art.Nr.: FGXCUS



QR-Code einfach scannen und
Austrotherm Materiallisten-Generator
online nutzen.

Austrotherm Gesimseprofil

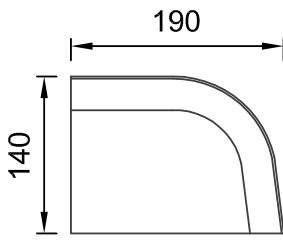

Art.Nr.: FGXCUU

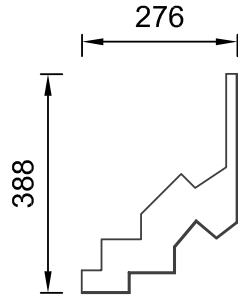

Art.Nr.: FGXCUY

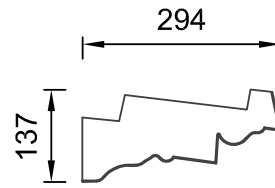

Art.Nr.: FGXCVC

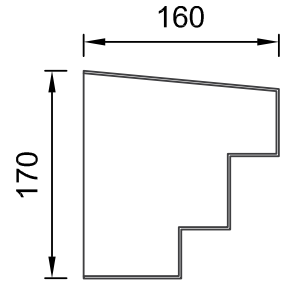

Art.Nr.: FGXCVG

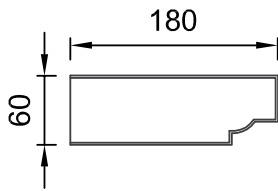

Art.Nr.: FGXCUV

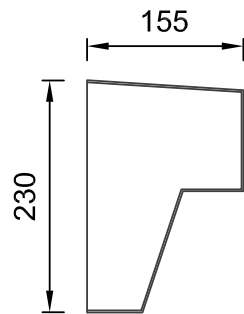

Art.Nr.: FGXCUZ

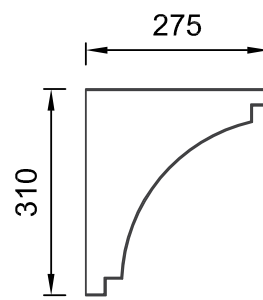

Art.Nr.: FGXCVD

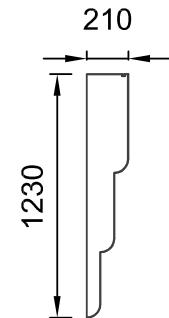

Art.Nr.: FGXCVH

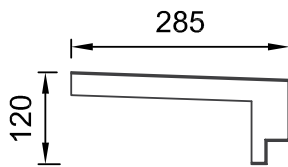

Art.Nr.: FGXC UW

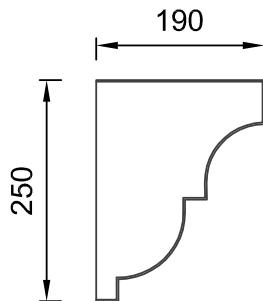

Art.Nr.: FGXCVA

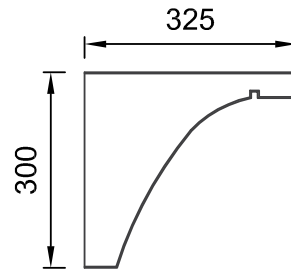

Art.Nr.: FGXCVE

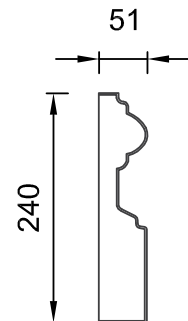

Art.Nr.: FGXCVI

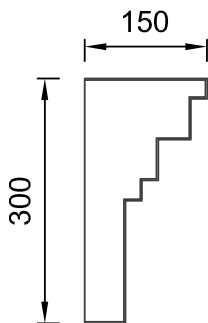

Art.Nr.: FGXCUX

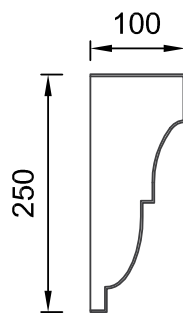

Art.Nr.: FGXCVB

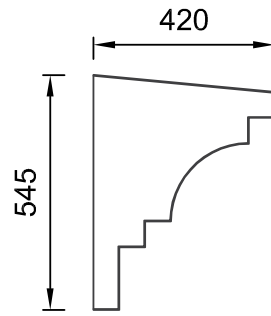

Art.Nr.: FGXC VF

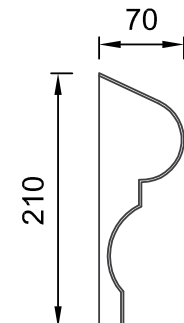

Art.Nr.: FGXC VJ



QR-Code einfach scannen und
Austrotherm Materiallisten-Generator
online nutzen.

Austrotherm Gesimseprofil

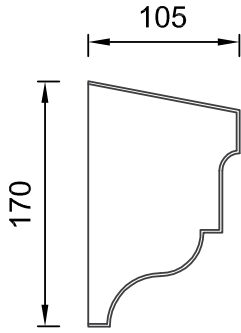

Art.Nr.: FGXCVK

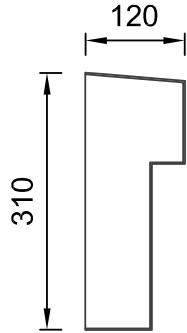

Art.Nr.: FGXCVO

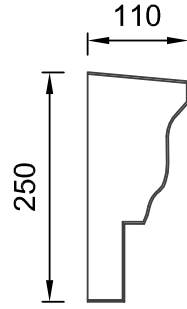

Art.Nr.: FGXCVS

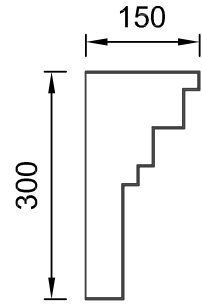

Art.Nr.: FGXCWV

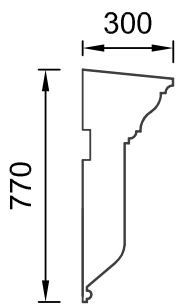

Art.Nr.: FGXCVL

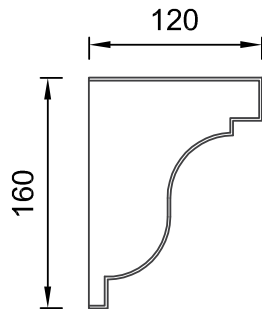

Art.Nr.: FGXCVP

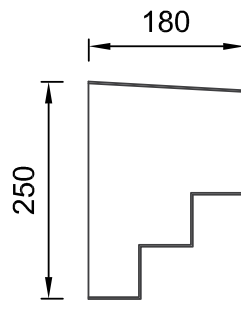

Art.Nr.: FGXCVT

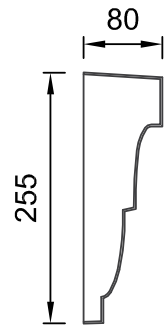

Art.Nr.: FGXCXV

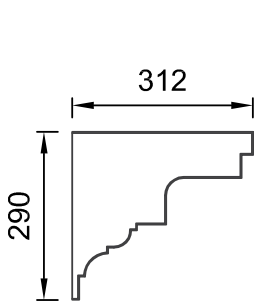

Art.Nr.: FGXCVM

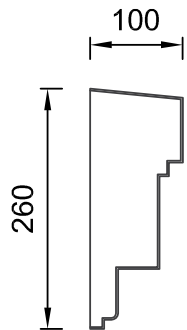

Art.Nr.: FGXCWQ

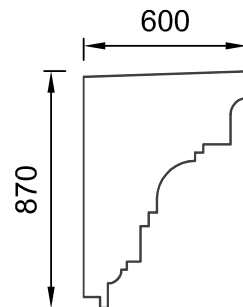

Art.Nr.: FGXCWU

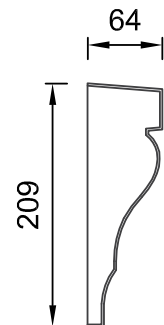

Art.Nr.: FGXCWV

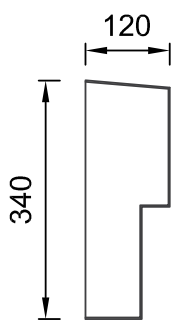

Art.Nr.: FGXCWN

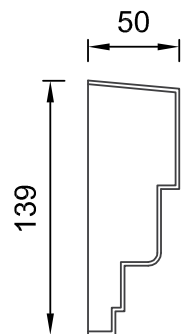

Art.Nr.: FGXCWR

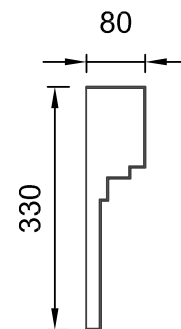

Art.Nr.: FGXCWV

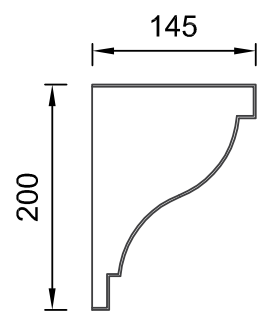

Art.Nr.: FGXCWZ



QR-Code einfach scannen und
Austrotherm Materiallisten-Generator
online nutzen.

Austrotherm Gesimseprofil

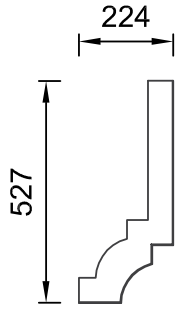

Art.Nr.: FGXCWA

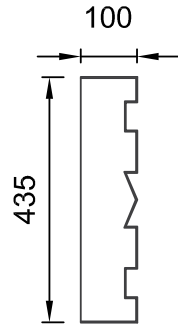

Art.Nr.: FGXCWE

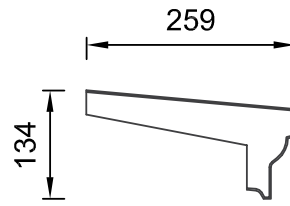

Art.Nr.: FGXCWK

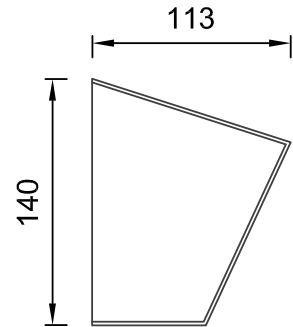

Art.Nr.: FGXCWO

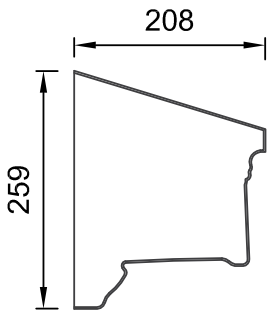

Art.Nr.: FGXCWB

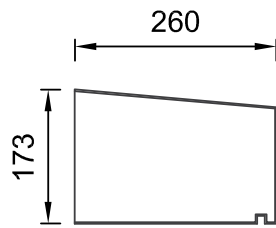

Art.Nr.: FGXCWF

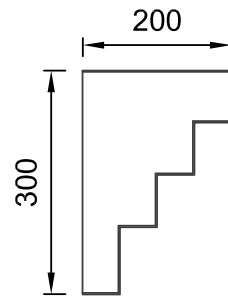

Art.Nr.: FGXCWL

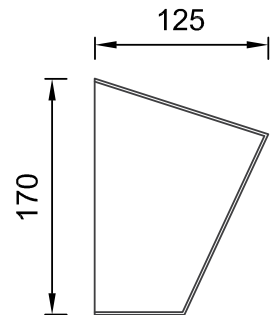

Art.Nr.: FGXCWP

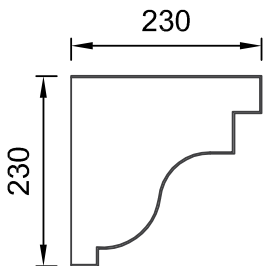

Art.Nr.: FGXCWC

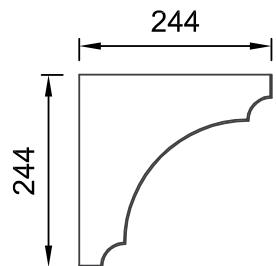

Art.Nr.: FGXCWG

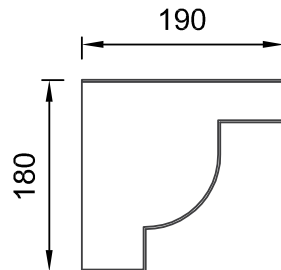

Art.Nr.: FGXCWM

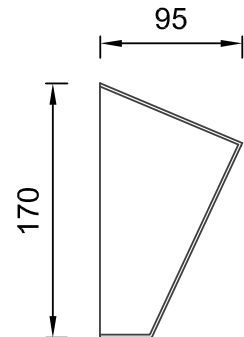

Art.Nr.: FGXCWQ

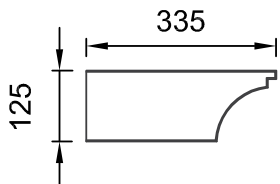

Art.Nr.: FGXCWD

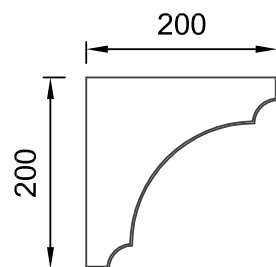

Art.Nr.: FGXCWH

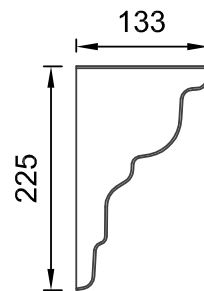

Art.Nr.: FGXCWN

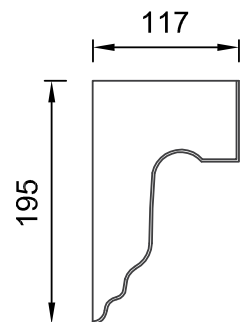

Art.Nr.: FGXCWR



QR-Code einfach scannen und
Austrotherm Materiallisten-Generator
online nutzen.

Austrotherm Gesimseprofil

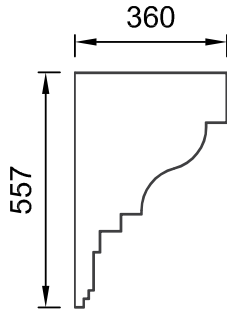

Art.Nr.: FGXCWS

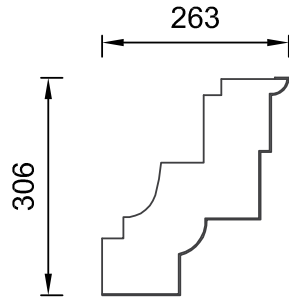

Art.Nr.: FGXCWW

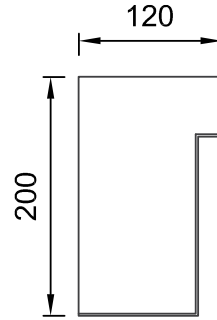

Art.Nr.: FGXCXA

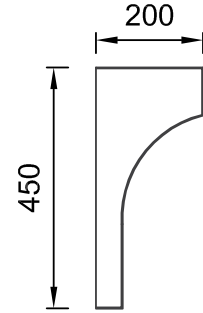

Art.Nr.: FGXCXE

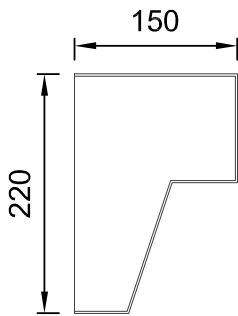

Art.Nr.: FGXCXE

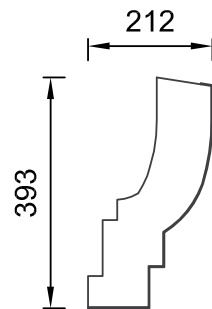

Art.Nr.: FGXCWX

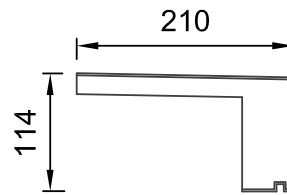

Art.Nr.: FGXCXB

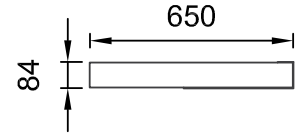

Art.Nr.: FGXCXF

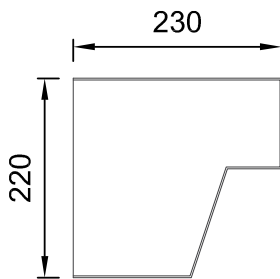

Art.Nr.: FGXCWU

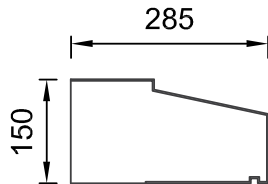

Art.Nr.: FGXCWY

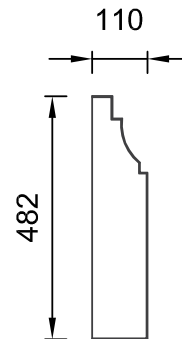

Art.Nr.: FGXCXC

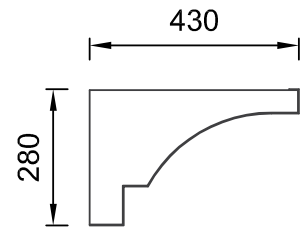

Art.Nr.: FGXCXG

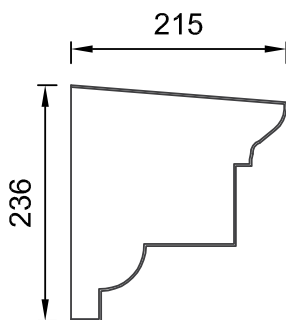

Art.Nr.: FGXCWV

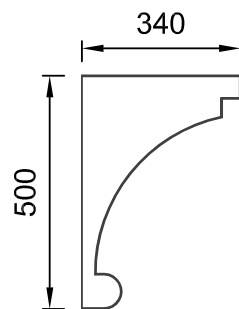

Art.Nr.: FGXCWZ

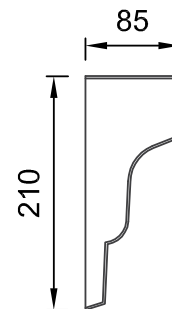

Art.Nr.: FGXCXD

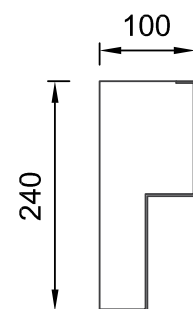

Art.Nr.: FGXCXH



QR-Code einfach scannen und
Austrotherm Materiallisten-Generator
online nutzen.

Austrotherm Gesimseprofil

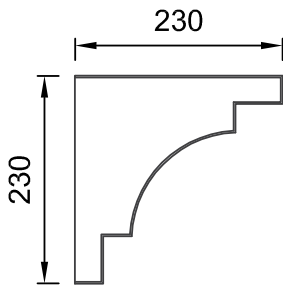

Art.Nr.: FGXCXI

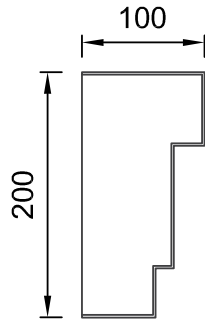

Art.Nr.: FGXCXM

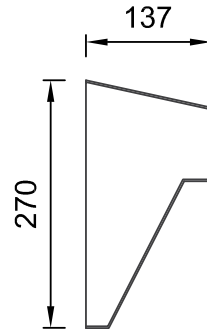

Art.Nr.: FGXCXQ

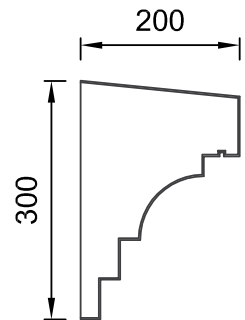

Art.Nr.: FGXCXU

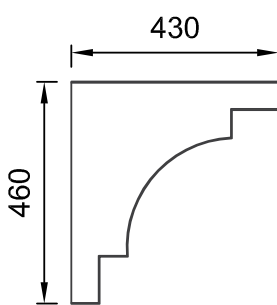

Art.Nr.: FGXCXJ

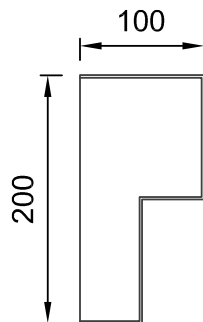

Art.Nr.: FGXCXN

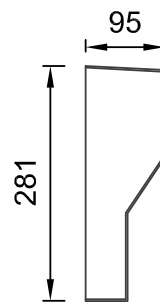

Art.Nr.: FGXCXR

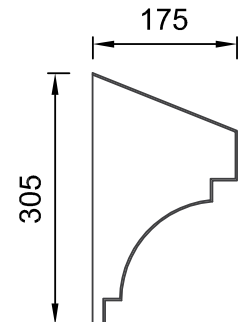

Art.Nr.: FGXCXV

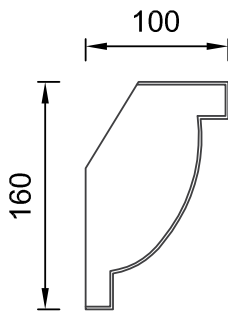

Art. Nr.: FGXCXK

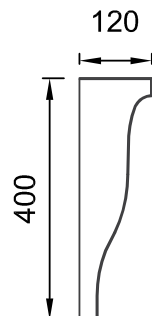

Art.Nr.: FGXCXO

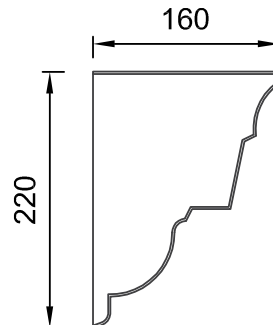

Art.Nr.: FGXCXS

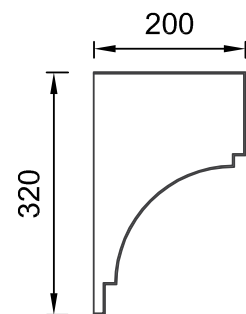

Art.Nr.: FGXCXW

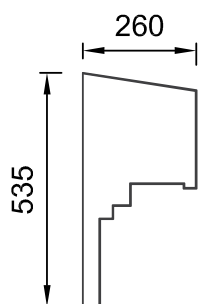

Art.Nr.: FGXCXL

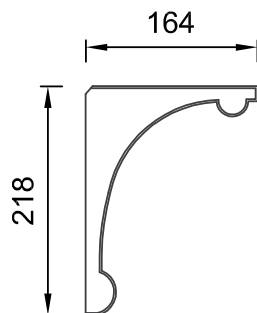

Art.Nr.: FGXCXP

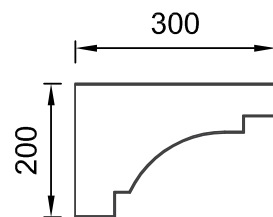

Art. Nr.: FGXCXT

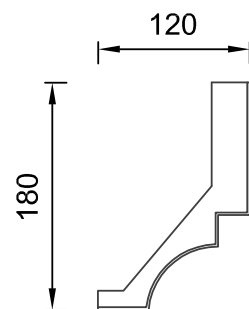

Art.Nr.: FGXCXX



QR-Code einfach scannen und
Austrotherm Materiallisten-Generator
online nutzen.

Austrotherm Gesimseprofil

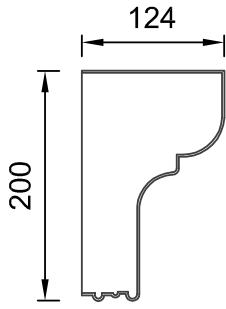

Art.Nr.: FGXCXY

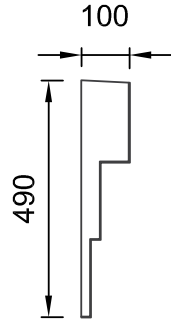

Art.Nr.: FGXCYC

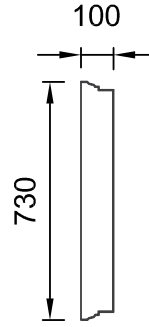

Art.Nr.: FGXCYG

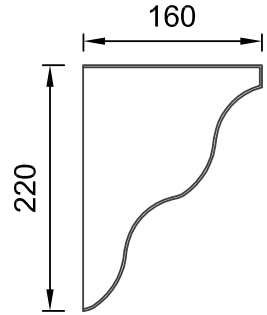

Art.Nr.: FGXCYK

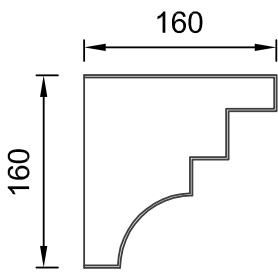

Art.Nr.: FGXCXZ

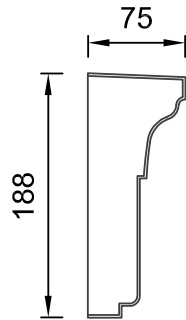

Art.Nr.: FGXCYD

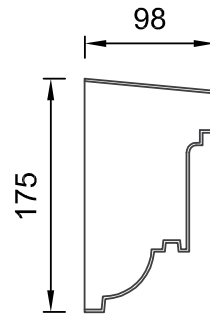

Art.Nr.: FGXCYH

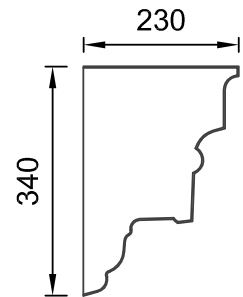

Art.Nr.: FGXCYL

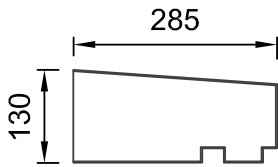

Art.Nr.: FGXCYA

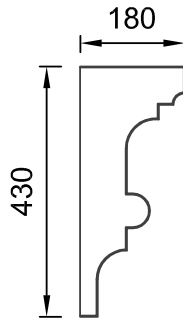

Art.Nr.: FGXCYE

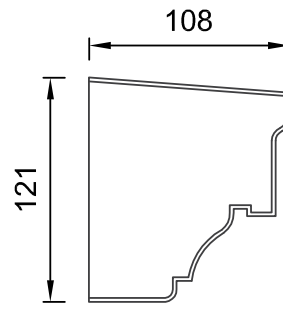

Art.Nr.: FGXCYI

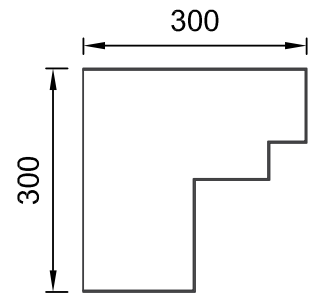

Art.Nr.: FGXCYM

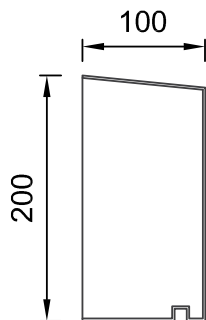

Art.Nr.: FGXCYB

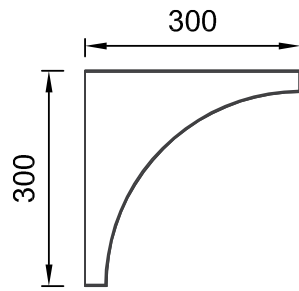

Art.Nr.: FGXCYF

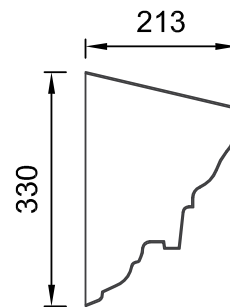

Art.Nr.: FGXCYJ

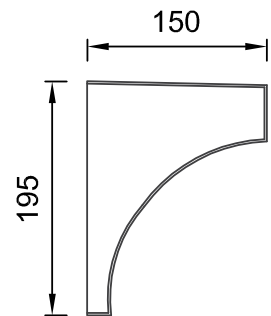

Art.Nr.: FGXCYN



QR-Code einfach scannen und
Austrotherm Materiallisten-Generator
online nutzen.

Austrotherm Gesimseprofil

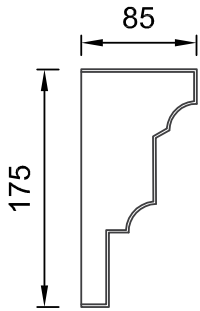

Art.Nr.: FGXCYO

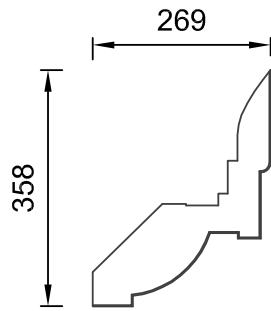

Art.Nr.: FGXCYS

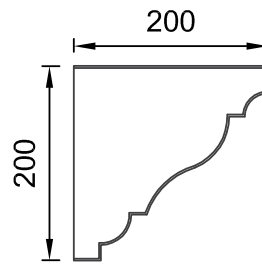

Art. Nr. FGXCYW

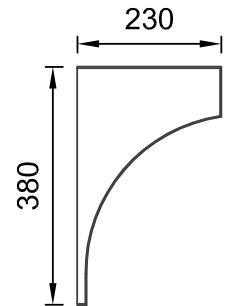

Art.Nr.: FGXCZA

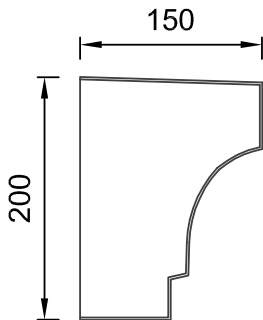

Art.Nr.: FGXCYP

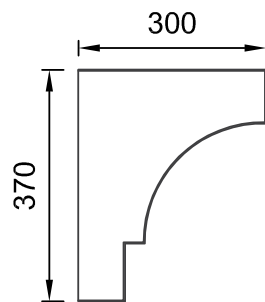

Art.Nr.: FGXCYT

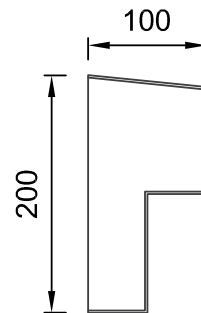

Art.Nr.: FGXCYX

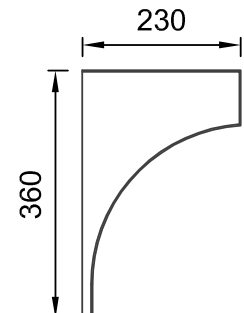

Art.Nr.: FGXCZB

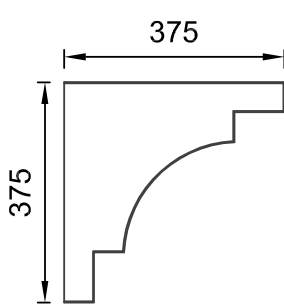

Art.Nr.: FGXCYQ

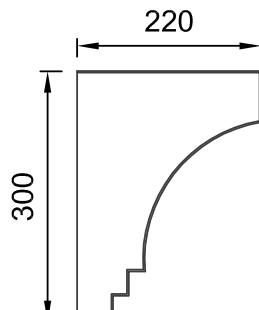

Art.Nr.: FGXCYU

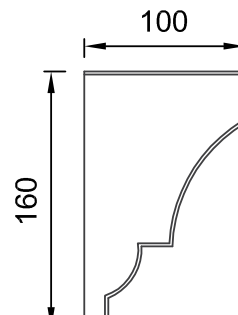

Art. Nr.: FGXCYY

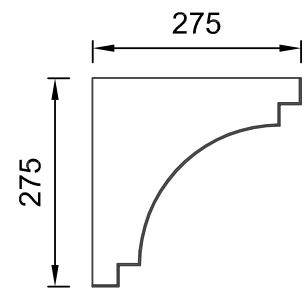

Art.Nr.: FGXCZC

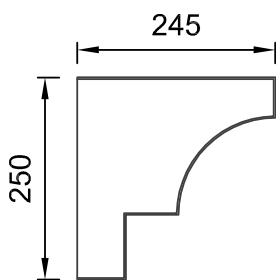

Art.Nr.: FGXCZR

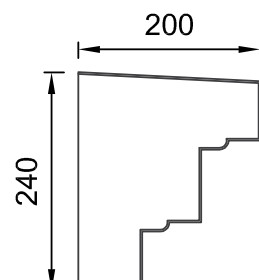

Art.Nr.: FGXCYV

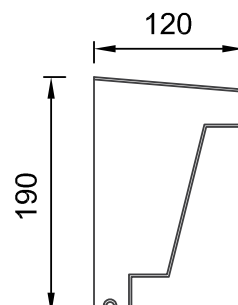

Art.Nr.: FGXCYZ

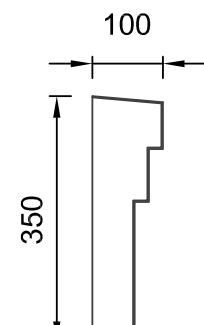

Art. Nr. FGXCZD



QR-Code einfach scannen und
Austrotherm Materiallisten-Generator
online nutzen.

Austrotherm Gesimseprofil

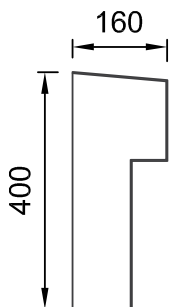

Art. Nr. FGXCZE

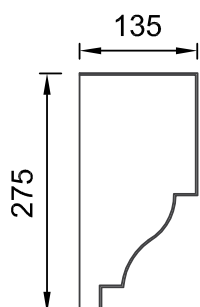

Art.Nr.: FGXCZJ

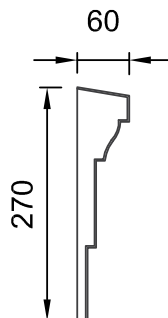

Art.Nr.: FGXCZN

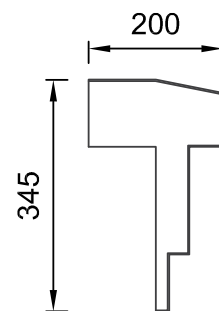

Art.Nr.: FGXCZR

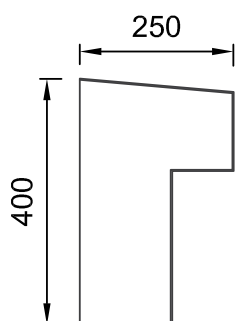

Art. Nr. FGXCZF

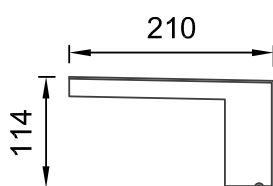

Art.Nr.: FGXCZK

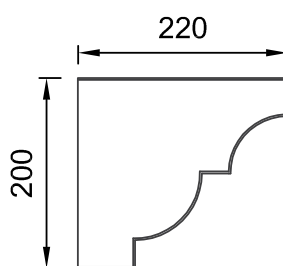

Art.Nr.: FGXCZO

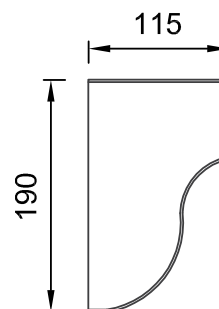

Art.Nr.: FGXCZS

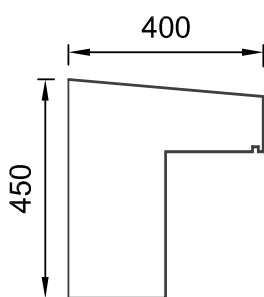

Art. Nr. FGXCZG

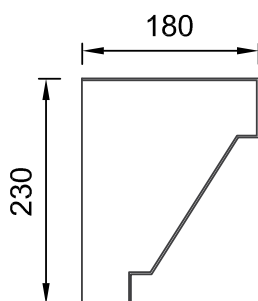

Art.Nr.: FGXCZL

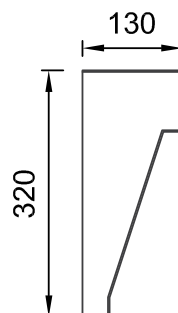

Art.Nr.: FGXCZP

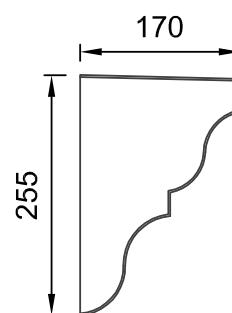

Art.Nr.: FGXCZT

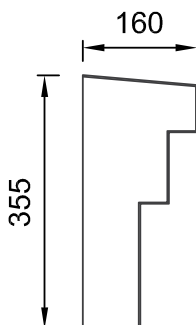

Art. Nr. FGXCZH

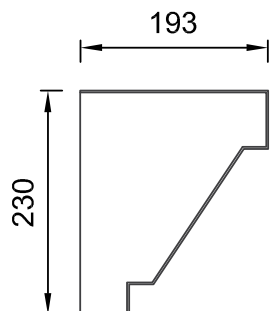

Art.Nr.: FGXCZM

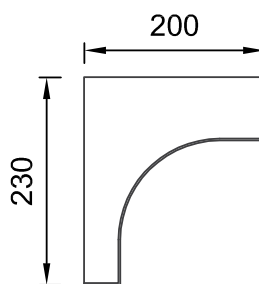

Art.Nr.: FGXCZQ

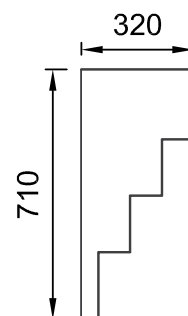

Art.Nr.: FGXCZU



QR-Code einfach scannen und
Austrotherm Materiallisten-Generator
online nutzen.

Austrotherm Gesimseprofil

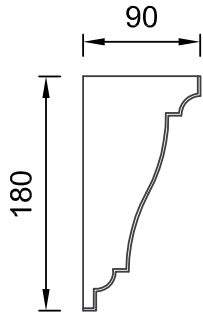

Art. Nr. FGXCZV

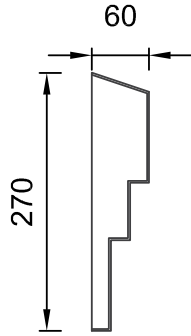

Art.Nr.: FGXCZZ

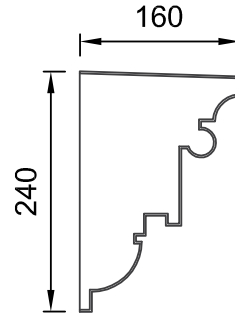

Art.Nr.: FGXDAD

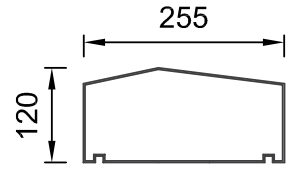

Art.Nr.: FGXDAH

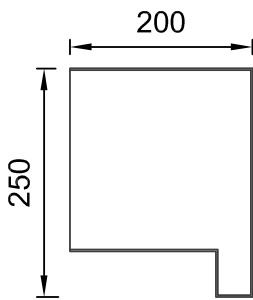

Art.Nr.: FGXCZW

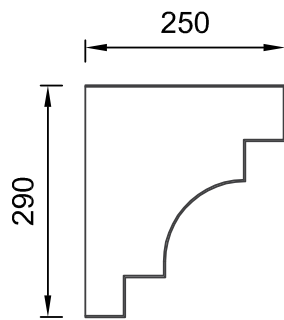

Art.Nr.: FGXDAA

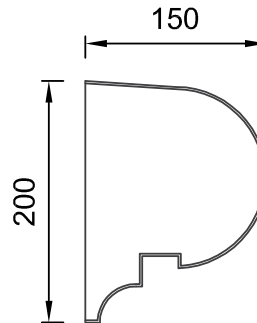

Art.Nr.: FGXDAE

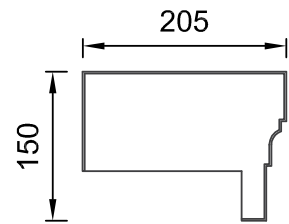

Art.Nr.: FGXDAI

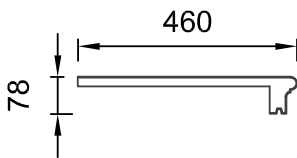

Art.Nr.: FGXCZX

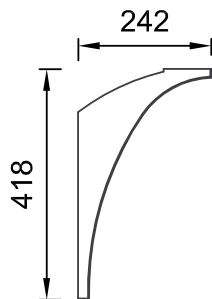

Art.Nr.: FGXDAB

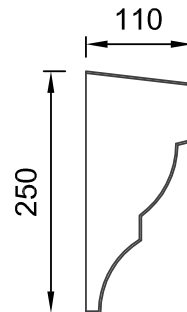

Art. Nr.: FGXDAB

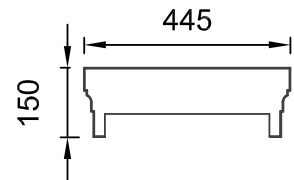

Art.Nr.: FGXDAJ

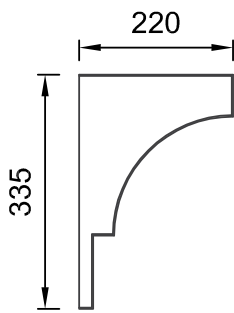

Art.Nr.: FGXCZY

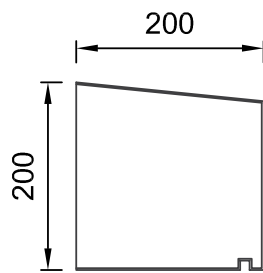

Art.Nr.: FGXDAC

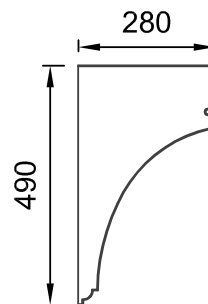

Art.Nr.: FGXDAG

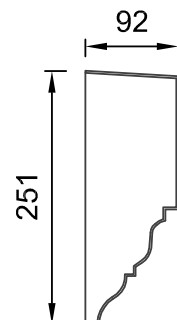

Art.Nr.: FGXDAK



QR-Code einfach scannen und
Austrotherm Materiallisten-Generator
online nutzen.

Austrotherm Gesimseprofil

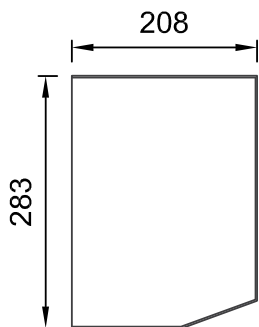

Art.Nr.: FGXDAL

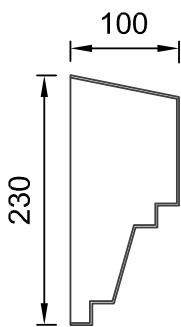

Art.Nr.: FGXDAP

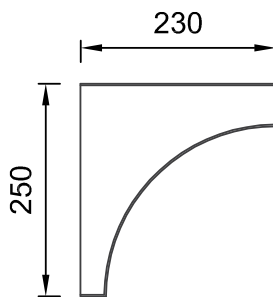

Art.Nr.: FGXDAT

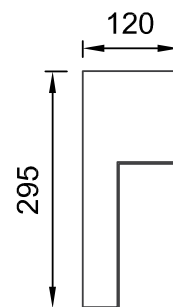

Art.Nr.: FGXDAX

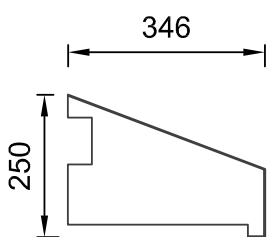

Art.Nr.: FGXDAM

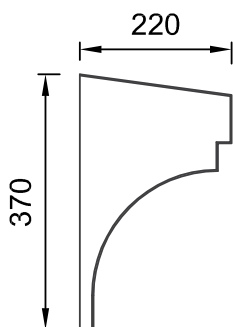

Art.Nr.: FGXDAQ

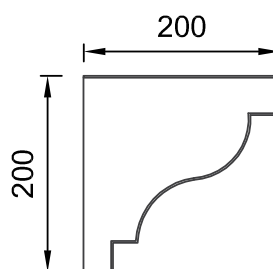

Art.Nr.: FGXDAU

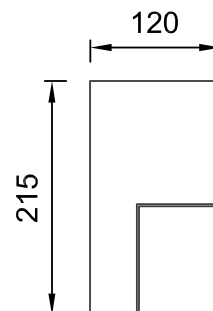

Art.Nr.: FGXDAY

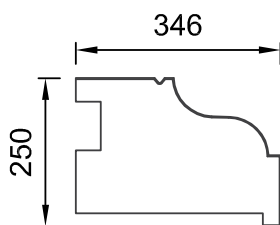

Art.Nr.: FGXDAN

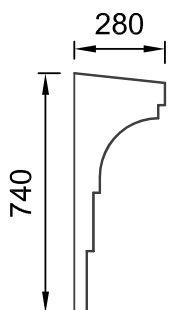

Art.Nr.: FGXDAR

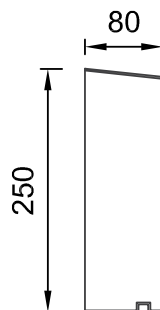

Art.Nr.: FGXDAV

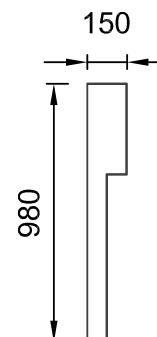

Art.Nr.: FGXDZ

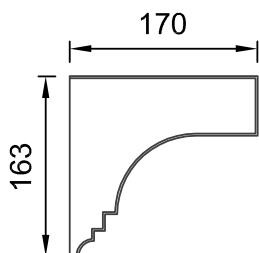

Art.Nr.: FGXDAO

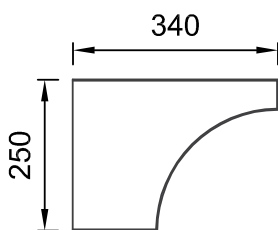

Art.Nr.: FGXDAS

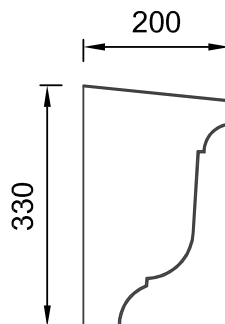

Art.Nr.: FGXDAW

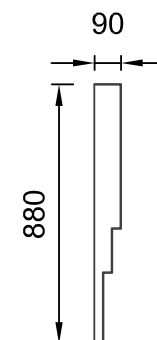

Art.Nr.: FGXDBA



QR-Code einfach scannen und
Austrotherm Materiallisten-Generator
online nutzen.

Austrotherm Gesimseprofil

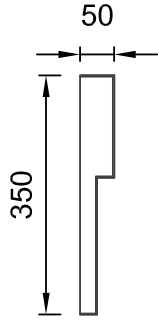

Art.Nr.: FGXDDB

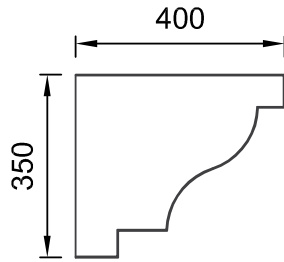

Art.Nr.: FGXDDBG

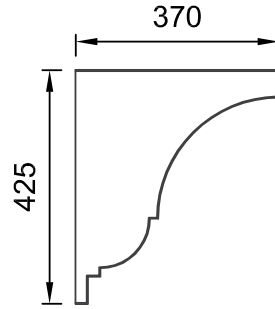

Art. Nr.: FGXDDBK

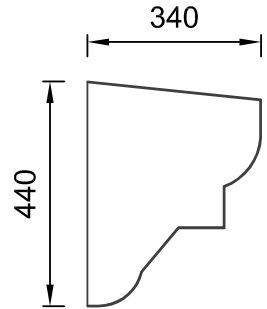

Art.Nr.: FGXDDBO

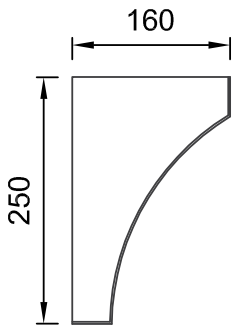

Art.Nr.: FGXDDBD

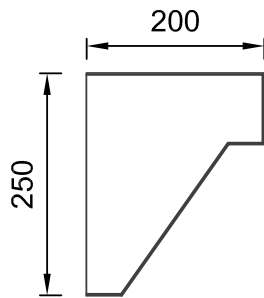

Art.Nr.: FGXDDBH

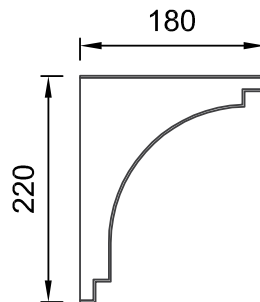

Art.Nr.: FGXDDBL

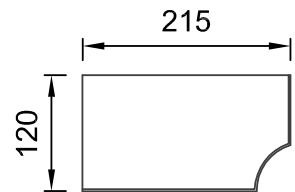

Art.Nr.: FGXDDBQ

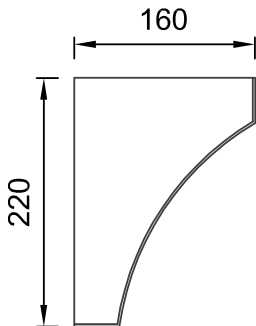

Art.Nr.: FGXDDBE

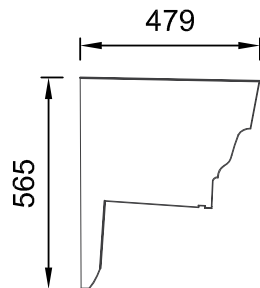

Art.Nr.: FGXDDBI

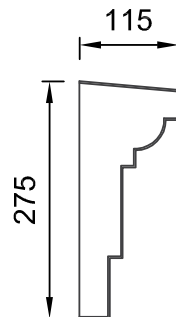

Art.Nr.: FGXDDBM

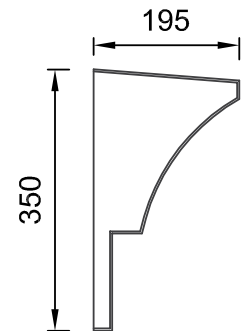

Art.Nr.: FGXDDBR

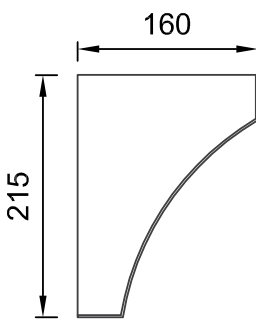

Art.Nr.: FGXDDBF

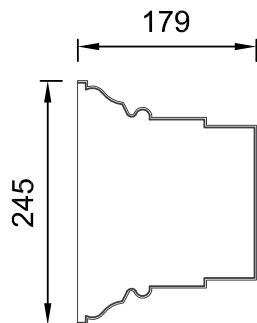

Art.Nr.: FGXDDBJ

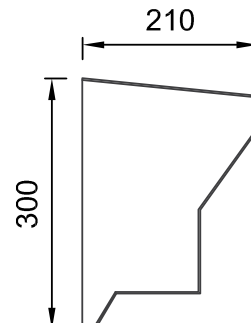

Art.Nr.: FGXDDBN

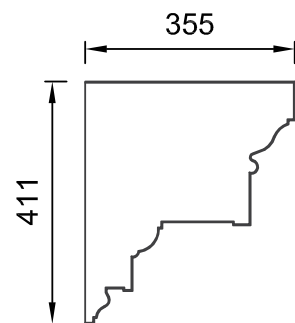

Art.Nr.: FGXDDBS



QR-Code einfach scannen und
Austrotherm Materiallisten-Generator
online nutzen.

Austrotherm Gesimseprofil

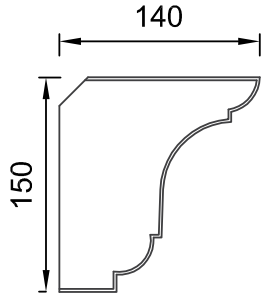

Art.Nr.: FGXDBT

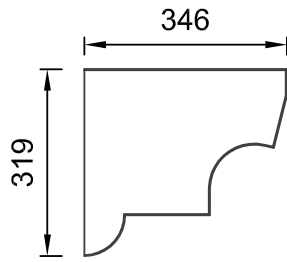

Art.Nr.: FGXDBX

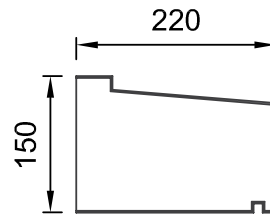

Art.Nr.: FGXDCC

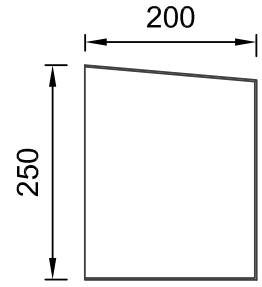

Art.Nr.: FGXDCJ

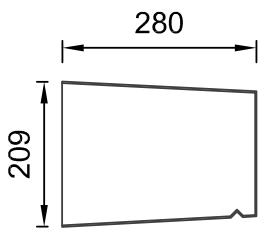

Art.Nr.: FGXDBU

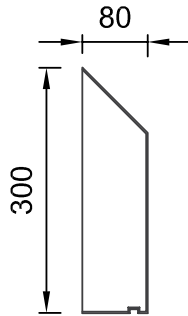

Art.Nr.: FGXDBY

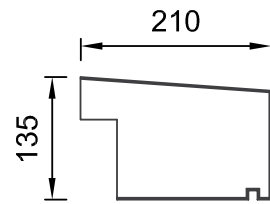

Art.Nr.: FGXDCE

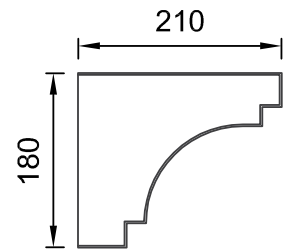

Art.Nr.: FGXDCK

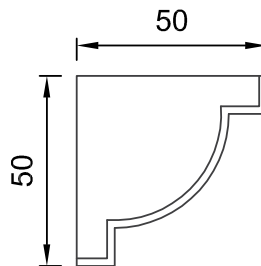

Art.Nr.: FGXDBV

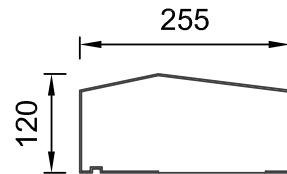

Art.Nr.: FGXDBZ

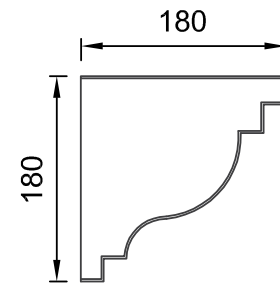

Art.Nr.: FGXDCCG

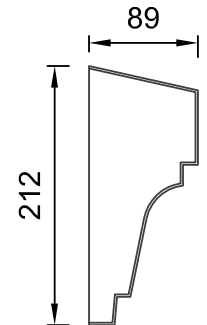

Art.Nr.: FGXDCL

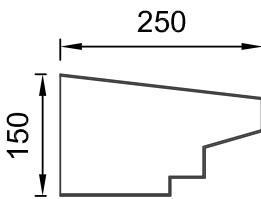

Art.Nr.: FGXDBW

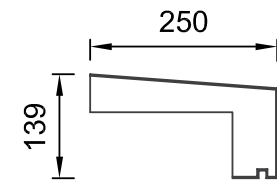

Art.Nr.: FGXDCCB

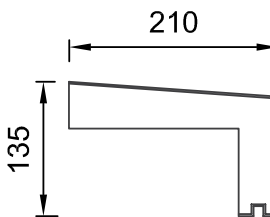

Art.Nr.: FGXDCCI

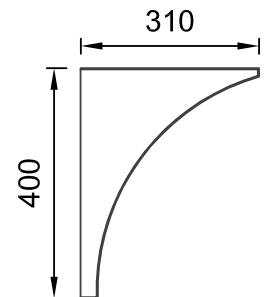

Art.Nr.: FGXDCCM



QR-Code einfach scannen und
Austrotherm Materiallisten-Generator
online nutzen.

Austrotherm Gesimseprofil

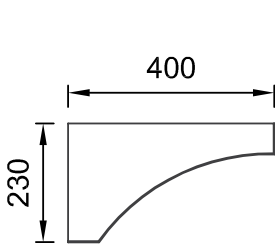

Art.Nr.: FGXDCN

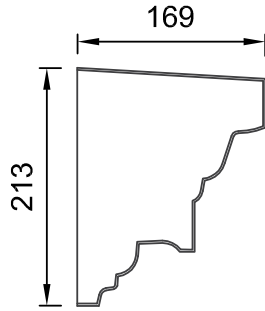

Art.Nr.: FGXDCR

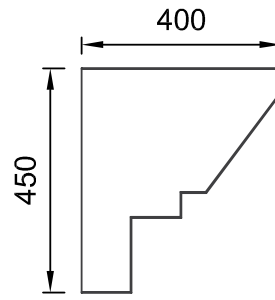

Art.Nr.: FGXDCV

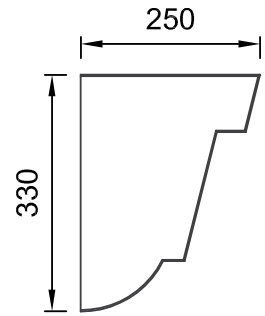

Art.Nr.: FGXDDA

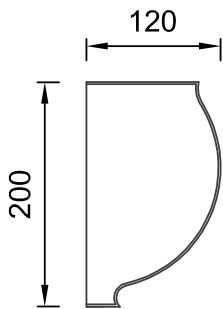

Art.Nr.: FGXDCC

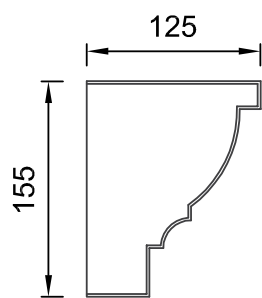

Art.Nr.: FGXDCE

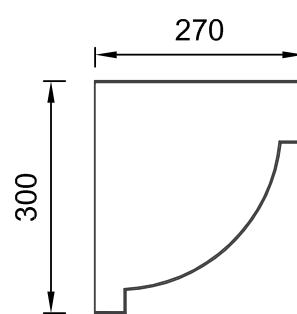

Art.Nr.: FGXDCH

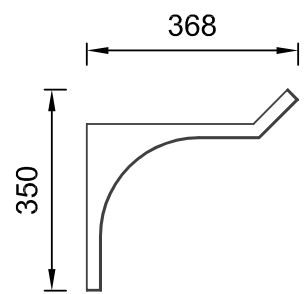

Art.Nr.: FGXDDB

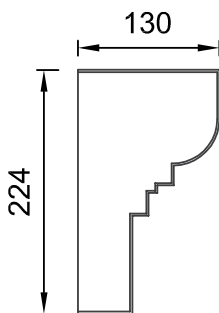

Art.Nr.: FGXDCL

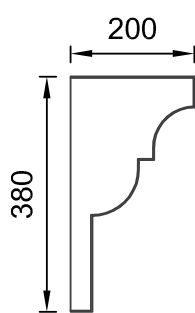

Art.Nr.: FGXDCT

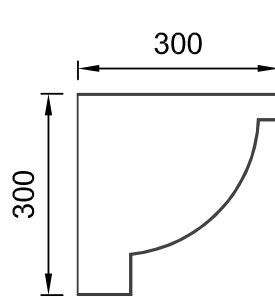

Art.Nr.: FGXDCH

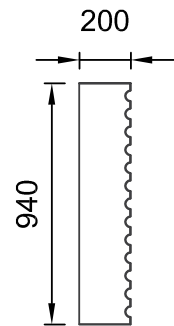

Art.Nr.: FGXDDD

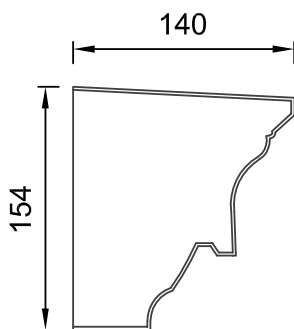

Art.Nr.: FGXDCC

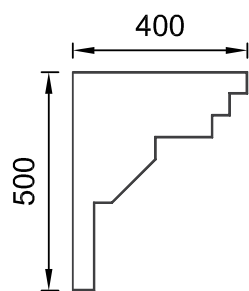

Art.Nr.: FGXDCE

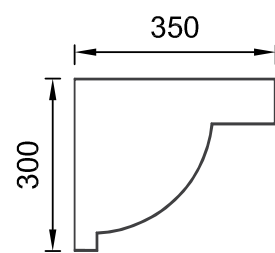

Art.Nr.: FGXDCH

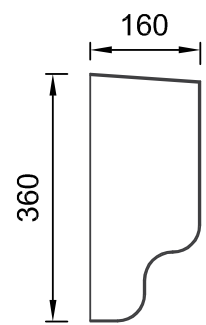

Art.Nr.: FGXDDE



QR-Code einfach scannen und
Austrotherm Materiallisten-Generator
online nutzen.

Austrotherm Gesimseprofil

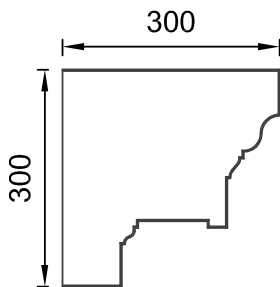

Art.Nr.: FGXDDF

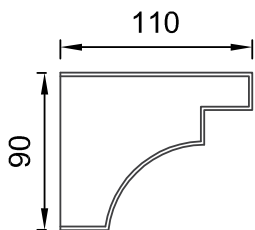

Art.Nr.: FGXDDJ

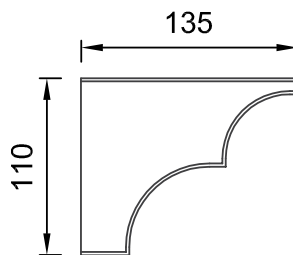

Art.Nr.: FGXDDN

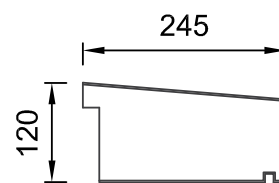

Art. Nr. FGXDDR

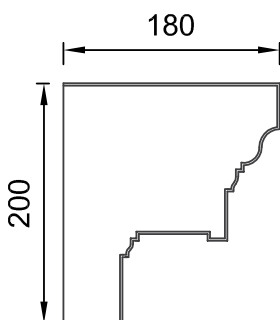

Art.Nr.: FGXDDG

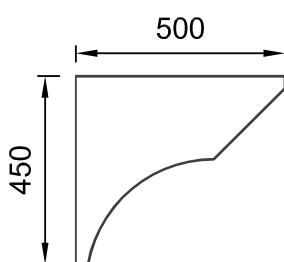

Art.Nr.: FGXDDK

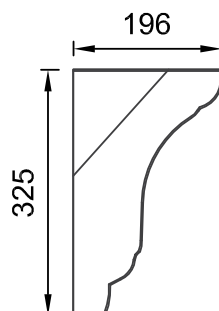

Art.Nr.: FGXDDO

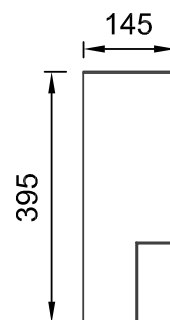

Art.Nr.: FGXDDS

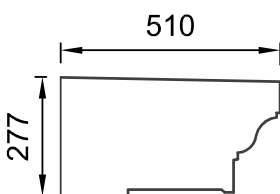

Art.Nr.: FGXDDH

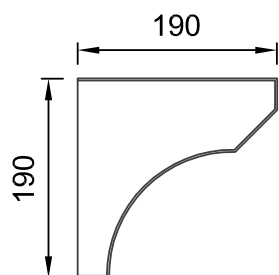

Art.Nr.: FGXDDL

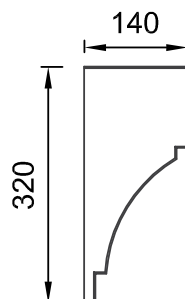

Art.Nr.: FGXDDP

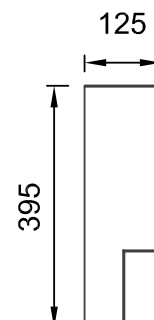

Art.Nr.: FGXDDT

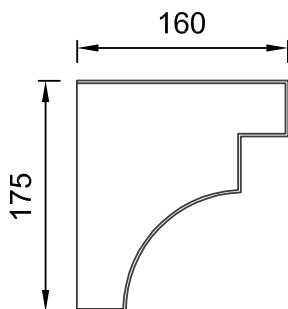

Art.Nr.: FGXDDI

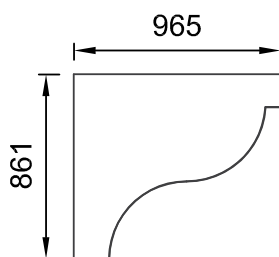

Art.Nr.: FGXDDM

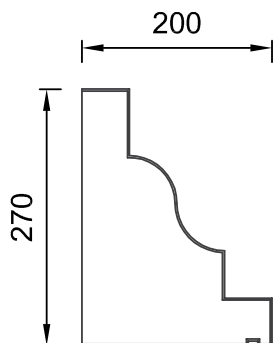

Art.Nr.: FGXDDQ

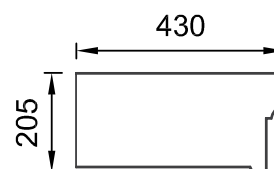

Art.Nr.: FGXDDU



QR-Code einfach scannen und
Austrotherm Materiallisten-Generator
online nutzen.

Austrotherm Gesimseprofil

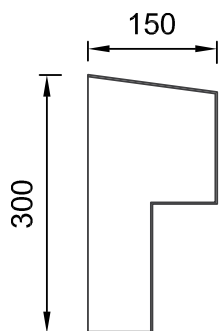

Art.Nr.: FGXDDV

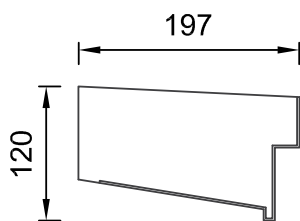

Art.Nr.: FGXDDZ

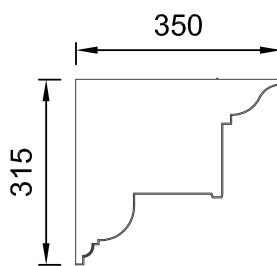

Art.Nr.: FGXDED

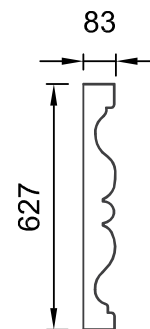

Art.Nr.: FGXDEH

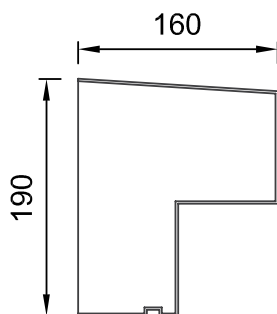

Art.Nr.: FGXDDW

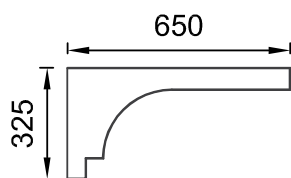

Art.Nr.: FGXDEA

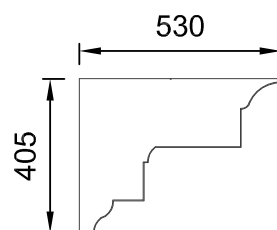

Art.Nr.: FGXDEE

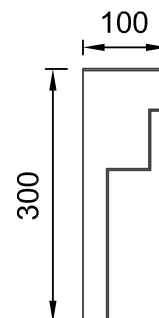

Art.Nr.: FGXDEI

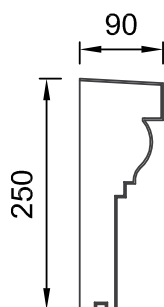

Art.Nr.: FGXDDX

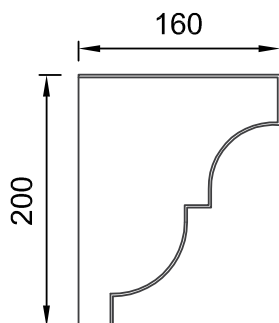

Art.Nr.: FGXDEB

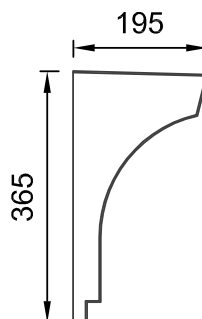

Art.Nr.: FGXDEF

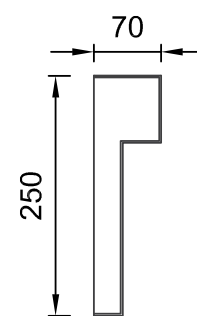

Art.Nr.: FGXDEJ

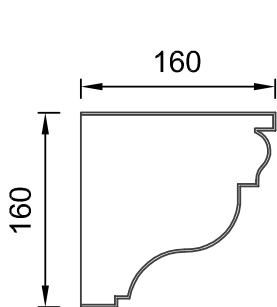

Art.Nr.: FGXDDY

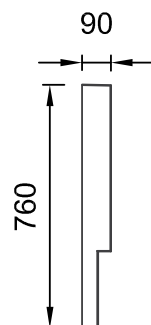

Art.Nr.: FGXDEC

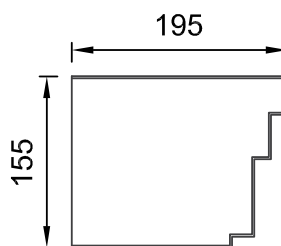

Art.Nr.: FGXDEG

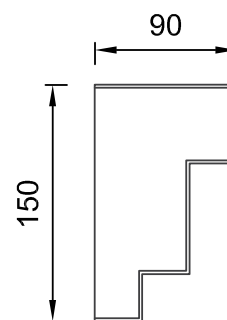

Art.Nr.: FGXDEK



QR-Code einfach scannen und
Austrotherm Materiallisten-Generator
online nutzen.

Austrotherm Gesimseprofil

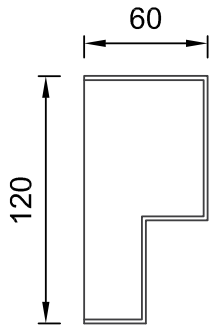

Art.Nr.: FGXDEL

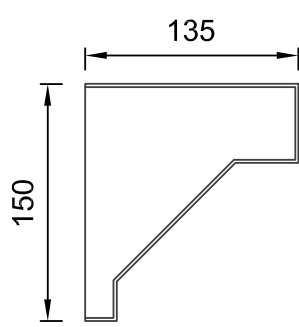

Art.Nr.: FGXDEP

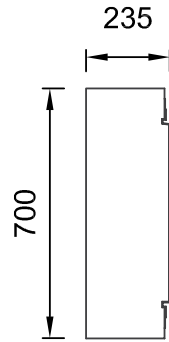

Art.Nr.: FGXDEV

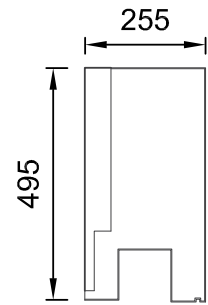

Art.Nr.: FGXDFD

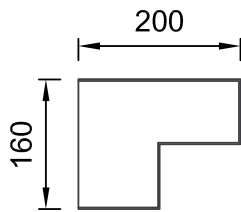

Art.Nr.: FGXDEM

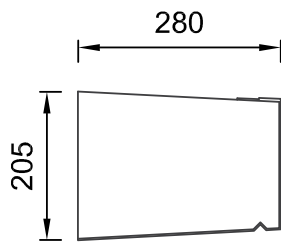

Art.Nr.: FGXDEQ

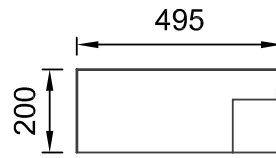

Art.Nr.: FGXDEX

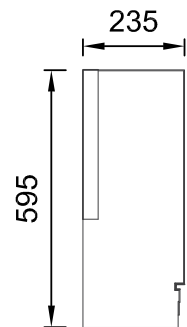

Art.Nr.: FGXDFE

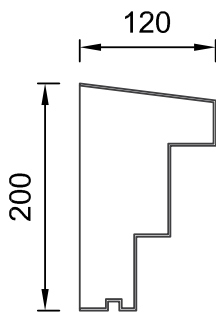

Art.Nr.: FGXDEN

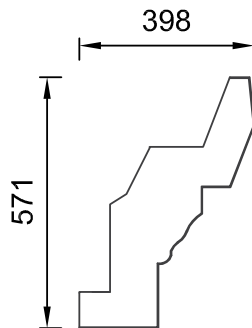

Art.Nr.: FGXDER

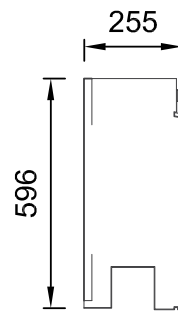

Art.Nr.: FGXDEZ

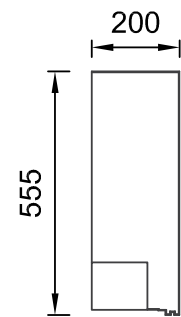

Art.Nr.: FGXDFH

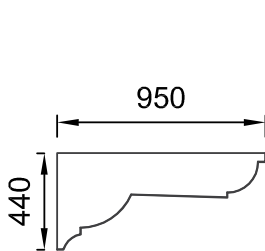

Art.Nr.: FGXDEO

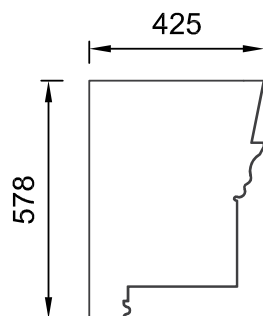

Art.Nr.: FGXDET

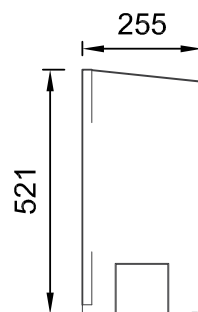

Art.Nr.: FGXDFB

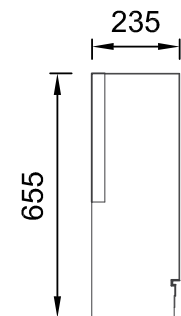

Art.Nr.: FGXDFJ



QR-Code einfach scannen und
Austrotherm Materiallisten-Generator
online nutzen.

Austrotherm Gesimseprofil

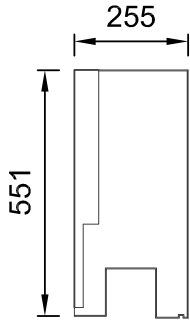

Art.Nr.: FGXDFL

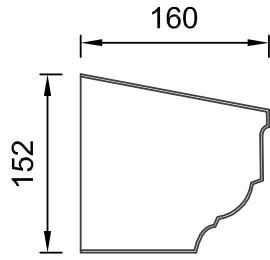

Art. Nr.: FGXDFS

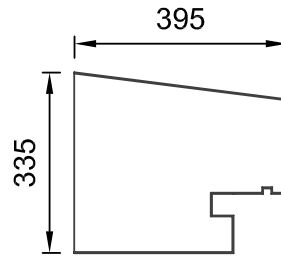

Art.Nr.: FGXDFW

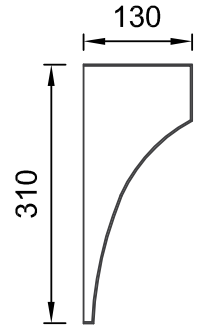

Art.Nr.: FGXDGA

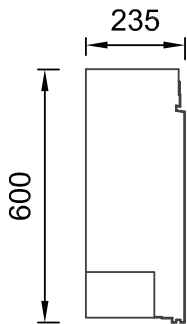

Art.Nr.: FGXDFN

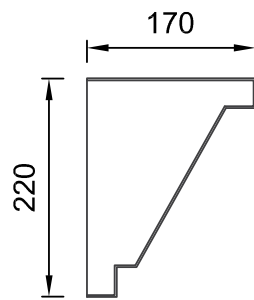

Art.Nr.: FGXDFT

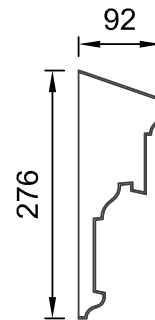

Art.Nr.: FGXDFX

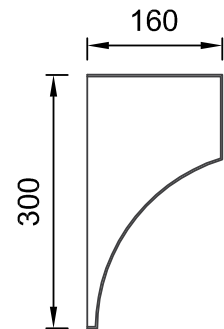

Art.Nr.: FGXDGB

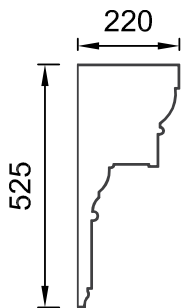

Art.Nr.: FGXDFFP

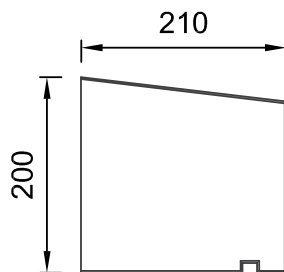

Art.Nr.: FGXDFU

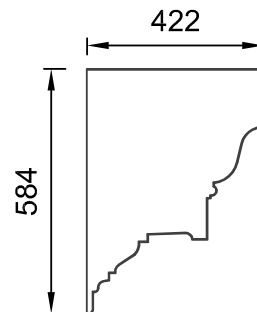

Art.Nr.: FGXDFFY

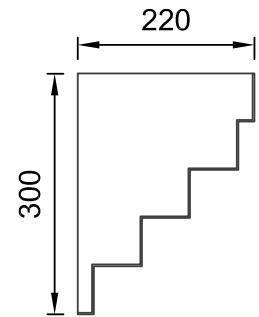

Art.Nr.: FGXDGC

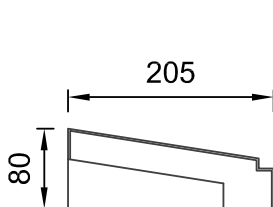

Art.Nr.: FGXDFFQ

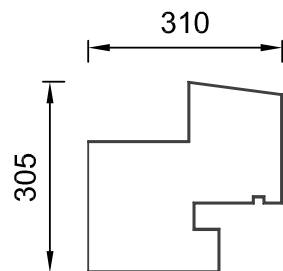

Art.Nr.: FGXDFFV

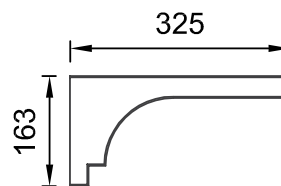

Art.Nr.: FGXDFFZ

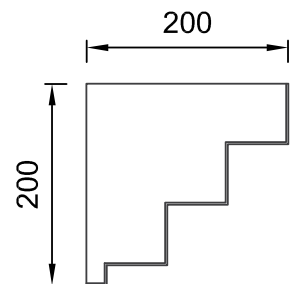

Art.Nr.: FGXDGE



QR-Code einfach scannen und
Austrotherm Materiallisten-Generator
online nutzen.

Austrotherm Gesimseprofil

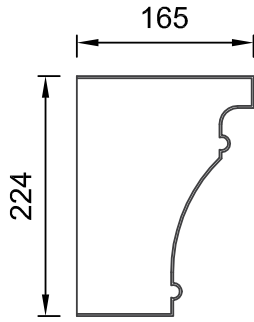

Art.Nr.: FGXDGG

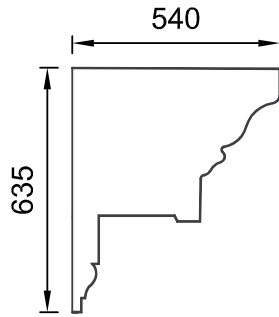

Art.Nr.: FGXDGK

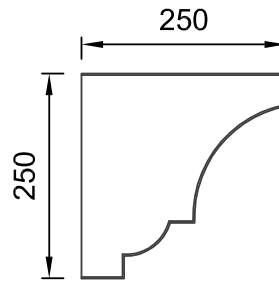

Art.Nr.: FGXDGQ

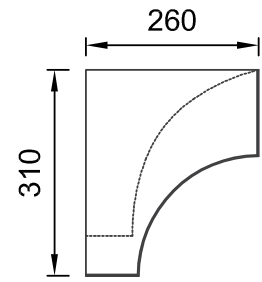

Art.Nr.: FGXDGX

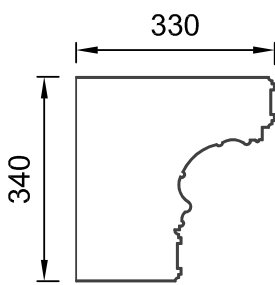

Art.Nr.: FGXDGH

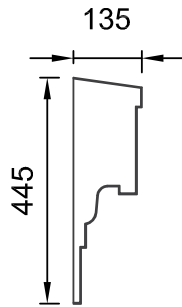

Art.Nr.: FGXDGL

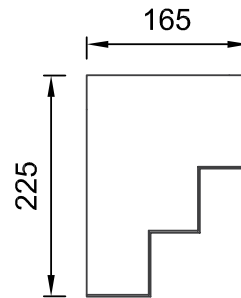

Art.Nr.: FGXDGR

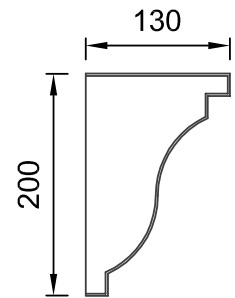

Art.Nr.: FGXDGZ

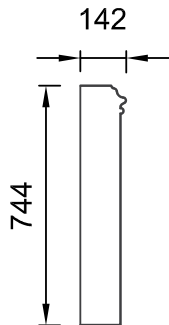

Art.Nr.: FGXDGI

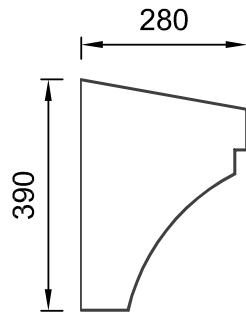

Art.Nr.: FGXDGM

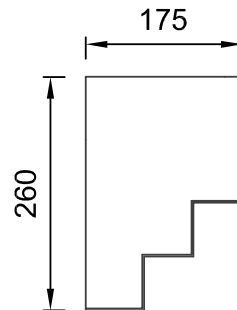

Art.Nr.: FGXDGT

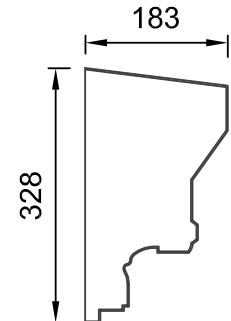

Art.Nr.: FGXDHA

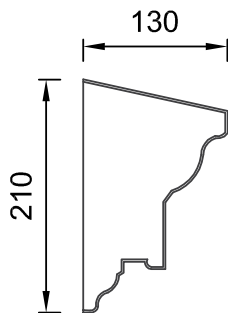

Art.Nr.: FGXDGJ

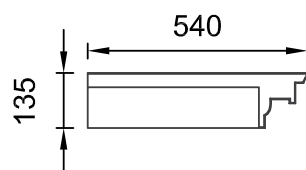

Art.Nr.: FGXDGP

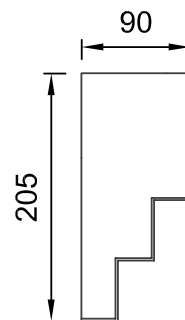

Art.Nr.: FGXDGV

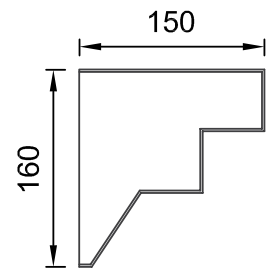

Art.Nr.: FGXDHB



QR-Code einfach scannen und
Austrotherm Materiallisten-Generator
online nutzen.

Austrotherm Gesimseprofil

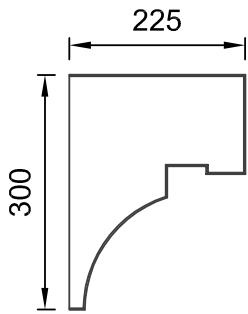

Art.Nr.: FGXDHC

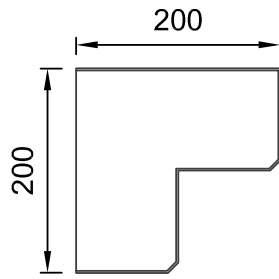

Art.Nr.: FGXDHG

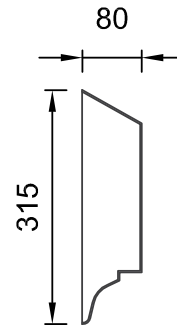

Art.Nr.: FGXDHK

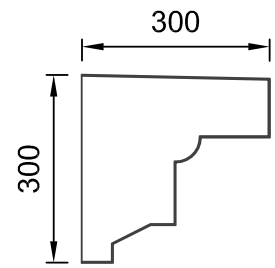

Art.Nr.: FGXDHO

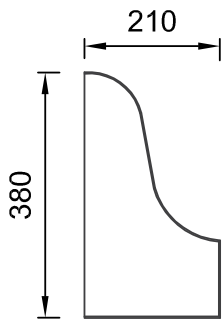

Art.Nr.: FGXDHD

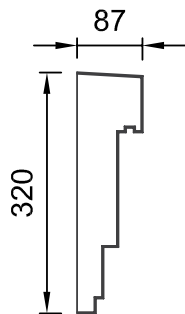

Art.Nr.: FGXDHH

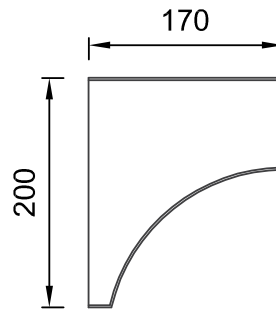

Art.Nr.: FGXDHL

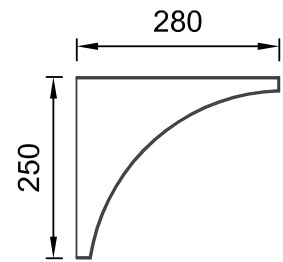

Art.Nr.: FGXDHP

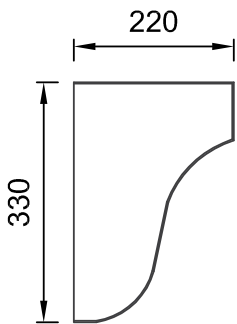

Art.Nr.: FGXDHE

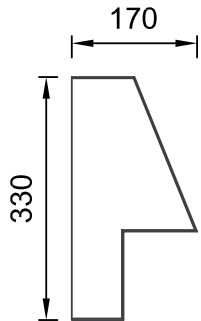

Art.Nr.: FGXDHI

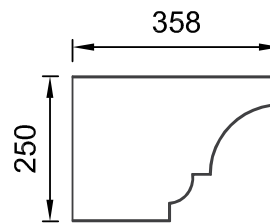

Art.Nr.: FGXDHM

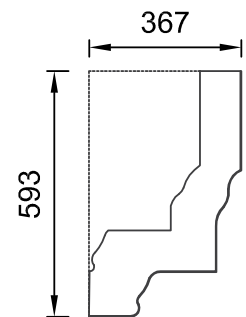

Art.Nr.: FGXDHQ

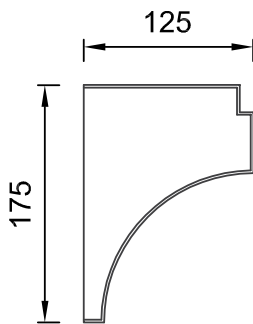

Art.Nr.: FGXDHF

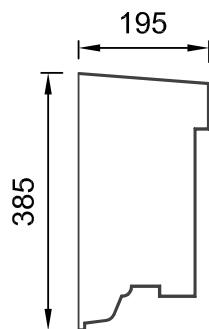

Art.Nr.: FGXDHJ

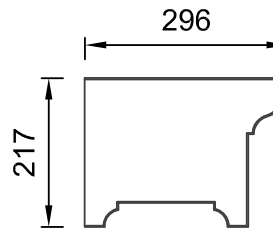

Art.Nr.: FGXDHN

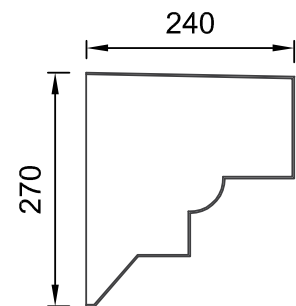

Art.Nr.: FGXDHS



QR-Code einfach scannen und
Austrotherm Materiallisten-Generator
online nutzen.

Austrotherm Gesimseprofil

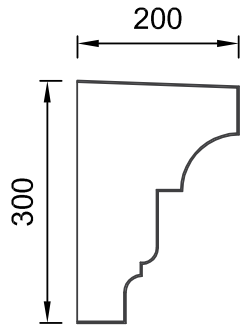

Art.Nr.: FGXDHT

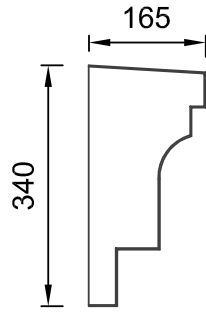

Art.Nr.: FGDXHX

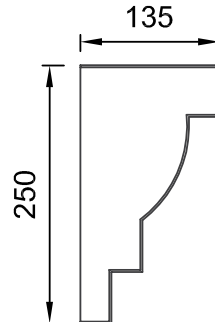

Art.Nr.: FGXDIB

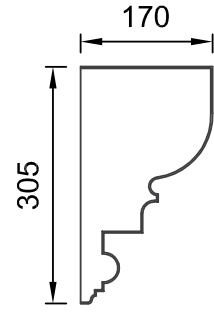

Art.Nr.: FGXDIH

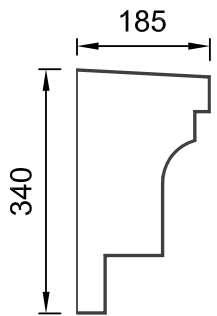

Art.Nr.: FGXDHU

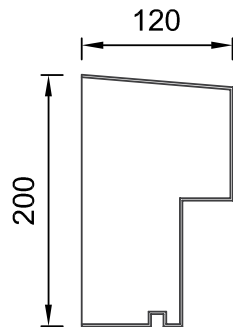

Art.Nr.: FGXDHY

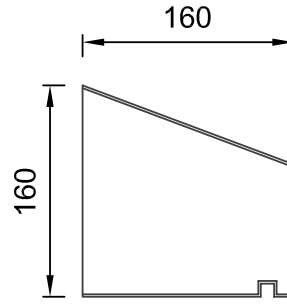

Art.Nr.: FGXDIC

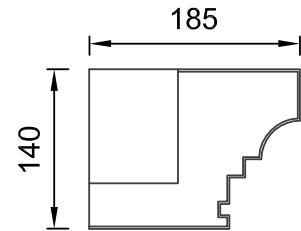

Art.Nr.: FGXDII

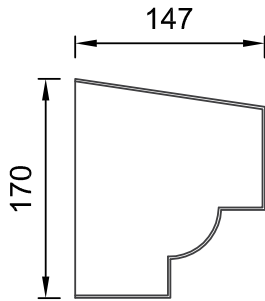

Art.Nr.: FGXDHV

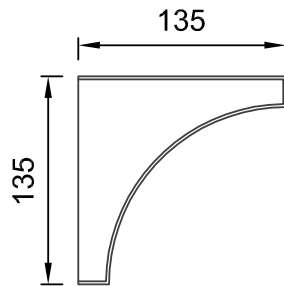

Art.Nr.: FGXDHZ

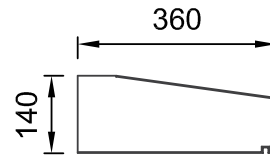

Art.Nr.: FGXDIE

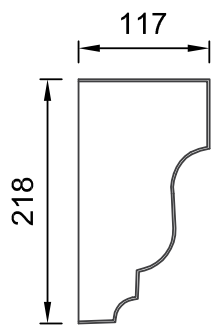

Art.Nr.: FGXDHV

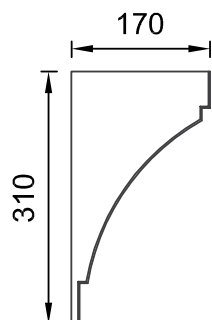

Art.Nr.: FGXDIA

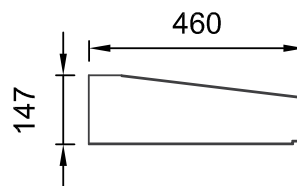

Art.Nr.: FGXDIF



QR-Code einfach scannen und
Austrotherm Materiallisten-Generator
online nutzen.

Austrotherm Leibungsprofil

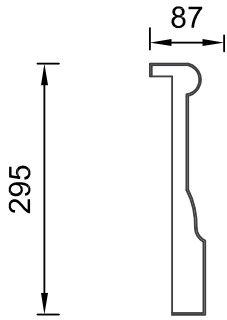

Art.Nr.:FLXAAD

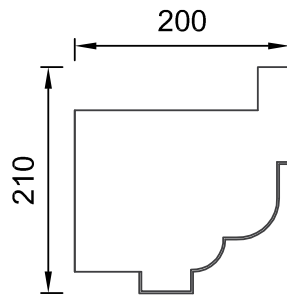

Art.Nr.:FLXAAH

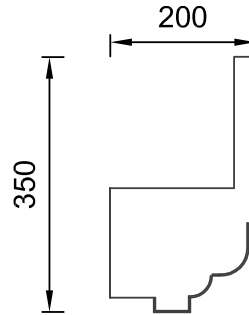

Art.Nr.:FLXAAQ

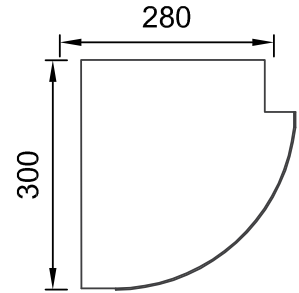

Art.Nr.:FLXAAV

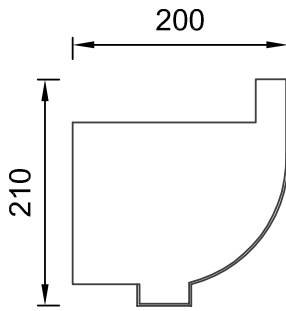

Art.Nr.:FLXAAE

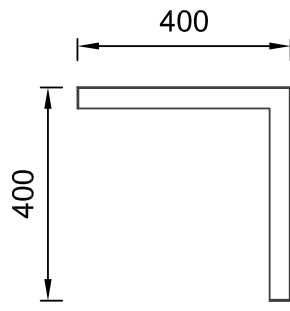

Art.Nr.:FLXAAI

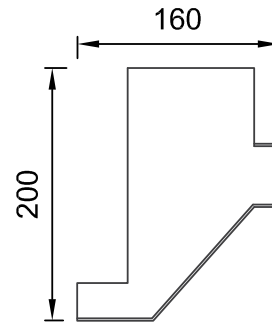

Art.Nr.:FLXAAS

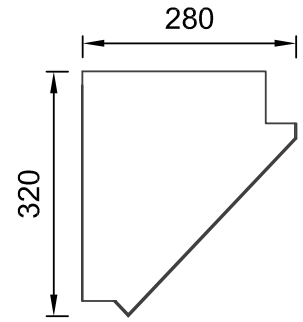

Art.Nr.:FLXAAW

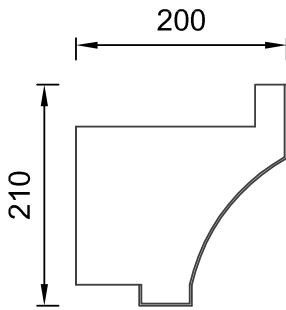

Art.Nr.:FLXAAF

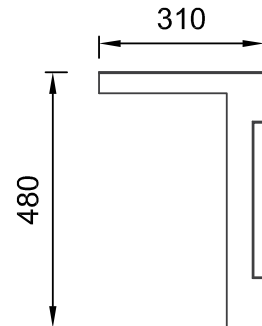

Art.Nr.:FLXAAAL

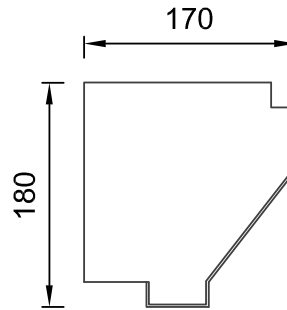

Art.Nr.:FLXAAT

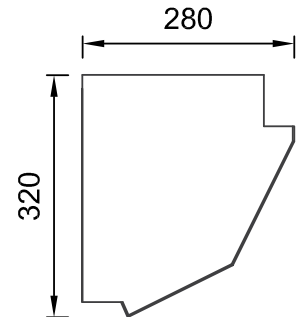

Art.Nr.:FLXAAX

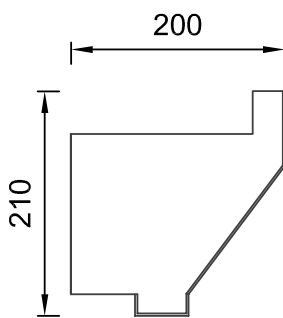

Art.Nr.:FLXAAG

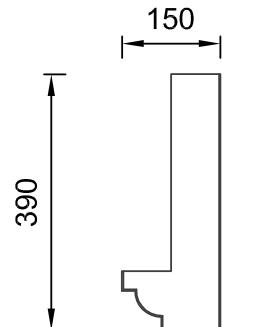

Art.Nr.:FLXAAP

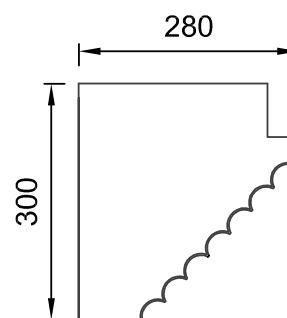

Art.Nr.:FLXAAU

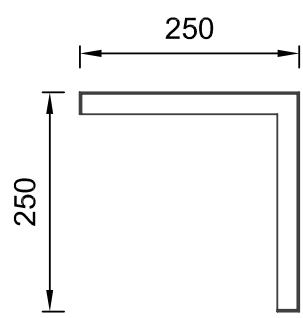

Art.Nr.:FLXAAAY



QR-Code einfach scannen und
Austrotherm Materiallisten-Generator
online nutzen.

Austrotherm Leibungsprofil

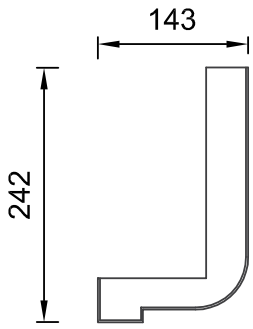

Art.Nr.:FLXAAZ

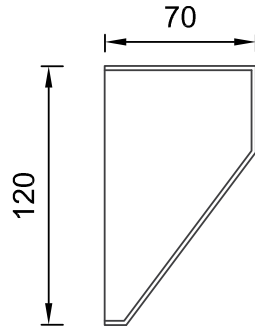

Art.Nr.:FLXABL

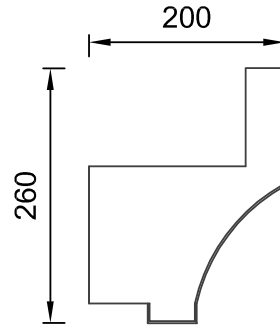

Art.Nr.:FLXABP

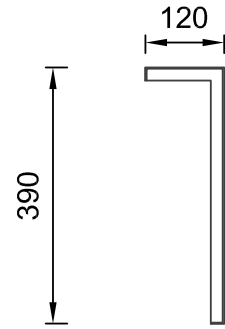

Art.Nr.:FLXABT

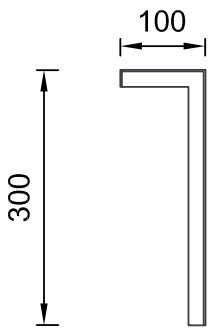

Art.Nr.:FLXABF

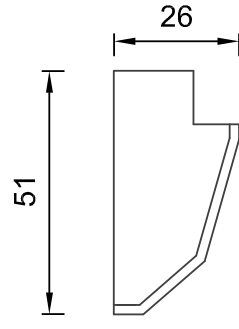

Art.Nr.:FLXABM

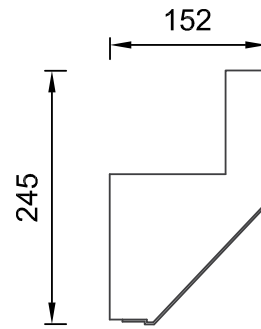

Art.Nr.:FLXABQ

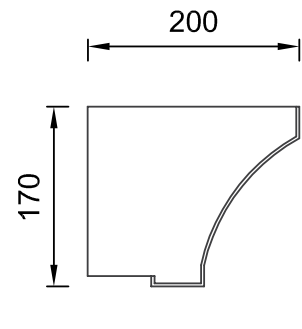

Art.Nr.:FLXABW

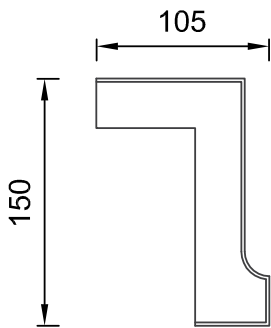

Art.Nr.:FLXABG

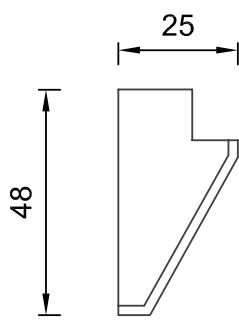

Art.Nr.:FLXABN

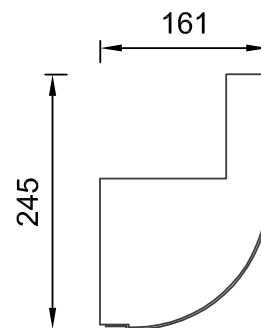

Art.Nr.:FLXABR

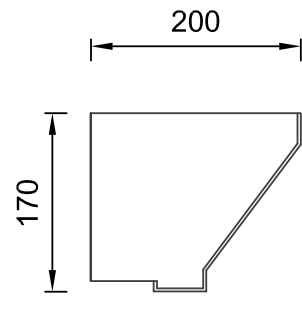

Art.Nr.:FLXABX

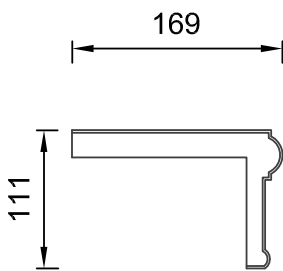

Art.Nr.:FLXABH

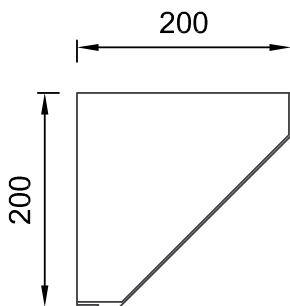

Art.Nr.:FLXABO

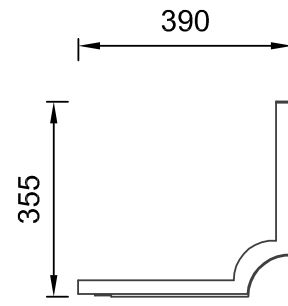

Art.Nr.:FLXABS

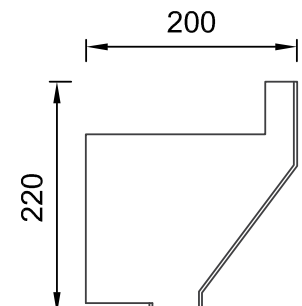

Art.Nr.:FLXABY



QR-Code einfach scannen und
Austrotherm Materialisten-Generator
online nutzen.

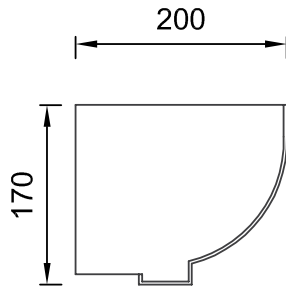

Art.Nr.:FLXABZ

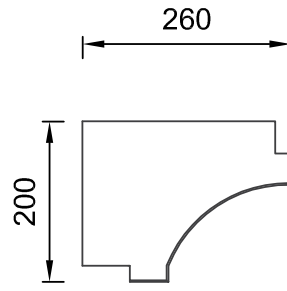

Art.Nr.:FLXACO

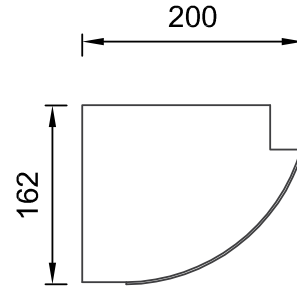

Art.Nr.:FLXADE

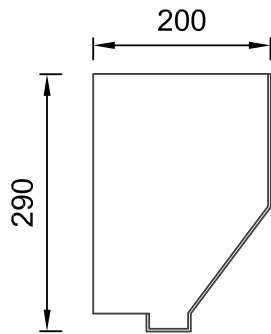

Art.Nr.:FLXACL

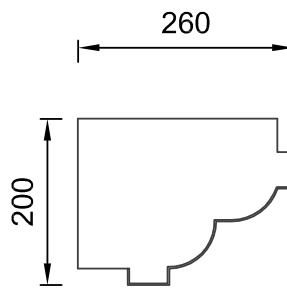

Art.Nr.:FLXACP

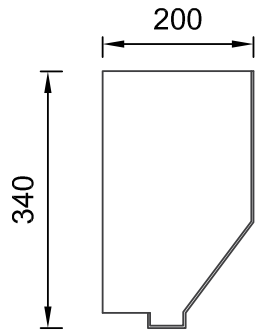

Art.Nr.:FLXACM

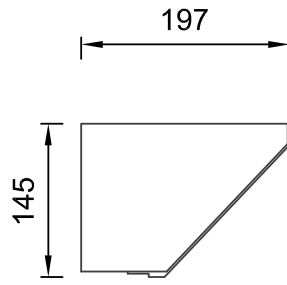

Art.Nr.:FLXACQ

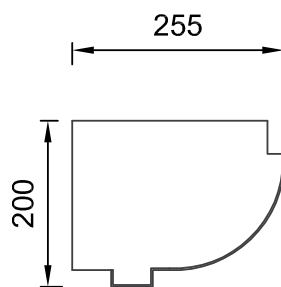

Art.Nr.:FLXACN

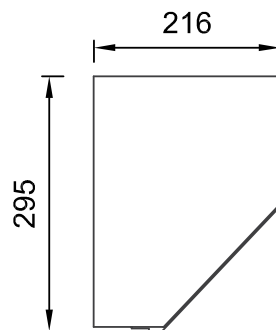

Art.Nr.:FLXACR



QR-Code einfach scannen und
Austrotherm Materiallisten-Generator
online nutzen.

Austrotherm Nutprofil

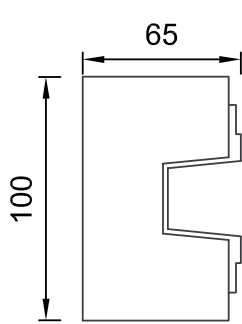

Art.Nr.:FNXAAA

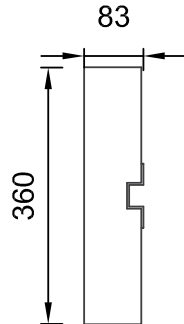

Art.Nr.:FNXAAG

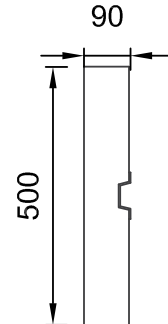

Art.Nr.:FNXAAM

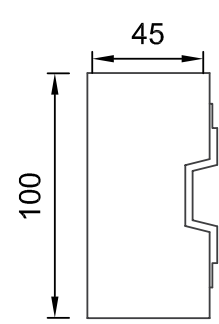

Art.Nr.:FNXAAQ

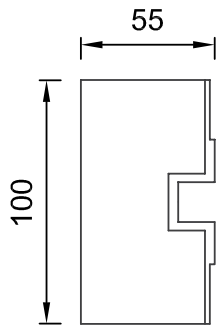

Art.Nr.:FNXAAC

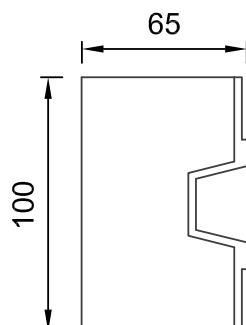

Art.Nr.:FNXAAH

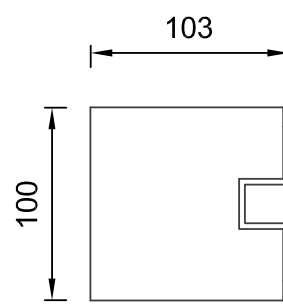

Art.Nr.:FNXAAN

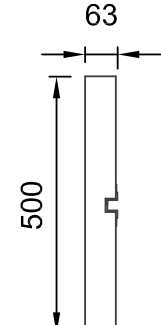

Art.Nr.:FNXAAR

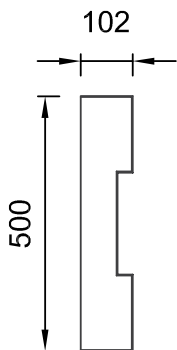

Art.Nr.:FNXAAD

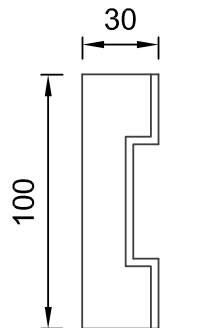

Art.Nr.:FNXAAI

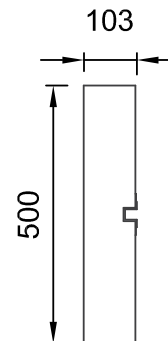

Art.Nr.:FNXAAO

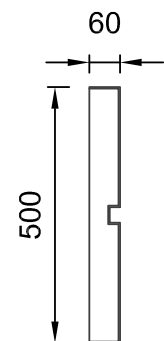

Art.Nr.:FNXAAS

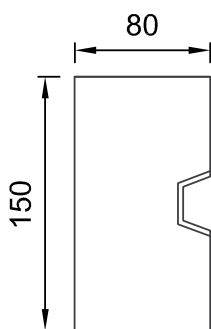

Art.Nr.:FNXAAF

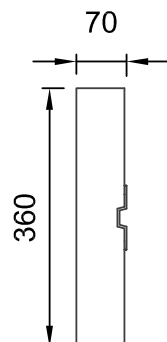

Art.Nr.:FNXAAL

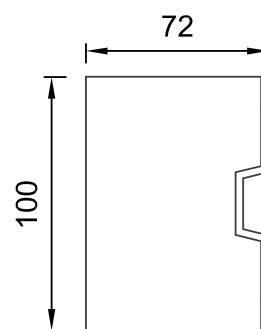

Art.Nr.:FNXAAP

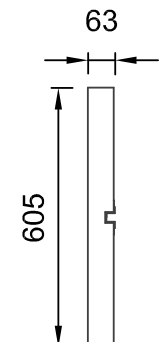

Art.Nr.:FNXAAT



QR-Code einfach scannen und
Austrotherm Materialisten-Generator
online nutzen.

Austrotherm Nutprofil

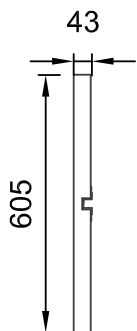

Art.Nr.:FNXAAU

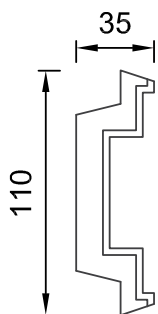

Art.Nr.:FNXABC

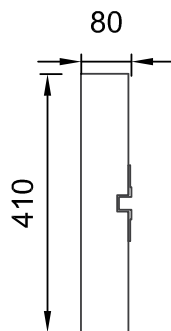

Art.Nr.:FNXABG

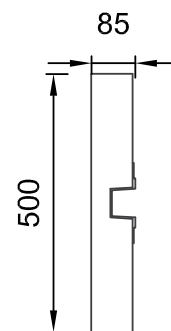

Art.Nr.:FNXABL

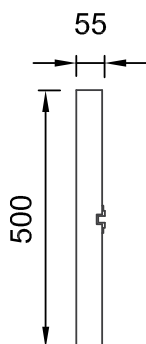

Art.Nr.:FNXAAY

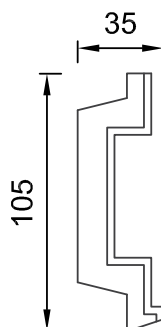

Art.Nr.:FNXABD

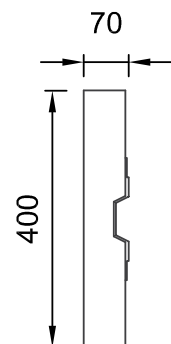

Art.Nr.:FNXABI

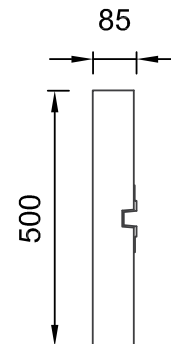

Art.Nr.:FNXABM

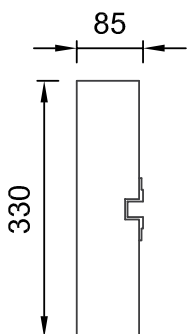

Art.Nr.:FNXAAZ

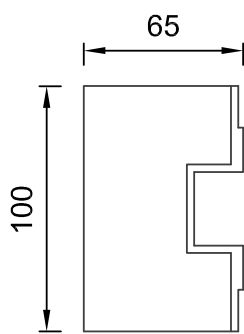

Art.Nr.:FNXABE

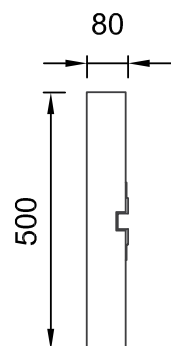

Art.Nr.:FNXABJ

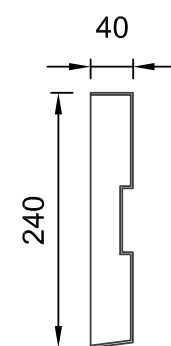

Art.Nr.:FNXABO

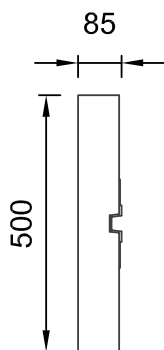

Art.Nr.:FNXABA

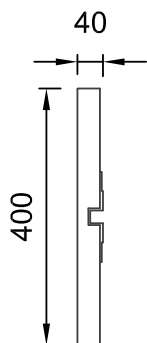

Art.Nr.:FNXABF

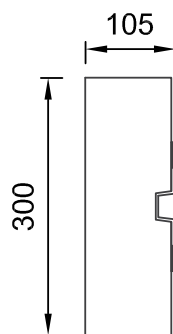

Art.Nr.:FNXABK

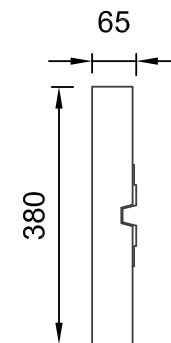

Art.Nr.:FNXABP



QR-Code einfach scannen und
Austrotherm Materialisten-Generator
online nutzen.

Austrotherm Nutprofil

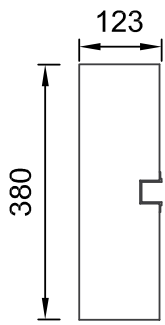

Art.Nr.:FNXABQ

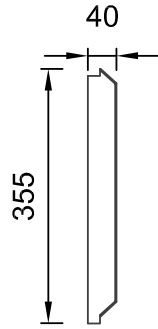

Art.Nr.:FNXABT

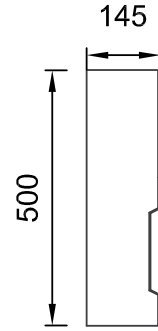

Art.Nr.:FNXABX

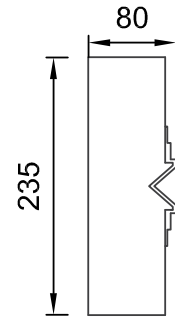

Art.Nr.:FNXACB

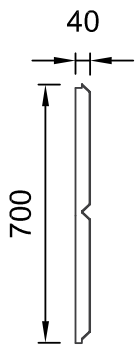

Art.Nr.:FNXABR

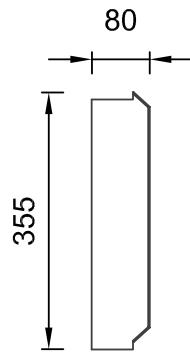

Art.Nr.:FNXABU

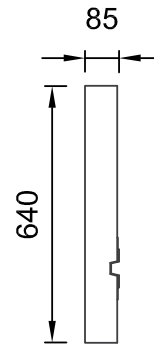

Art.Nr.:FNXABY

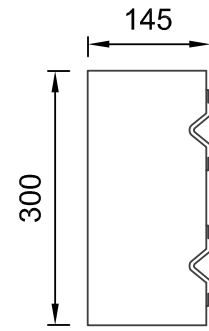

Art.Nr.:FNXACC

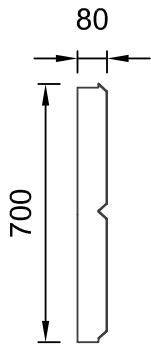

Art.Nr.:FNXABS

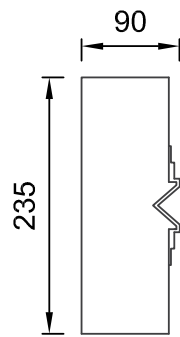

Art.Nr.:FNXABV

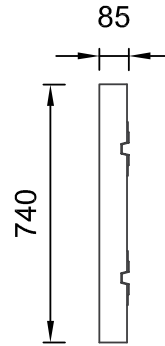

Art.Nr.:FNXABZ

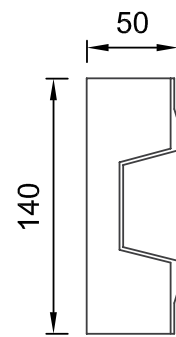

Art.Nr.:FNXACD

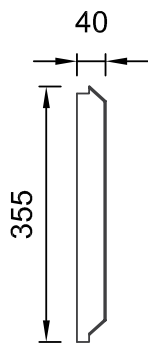

Art.Nr.:FNXABT

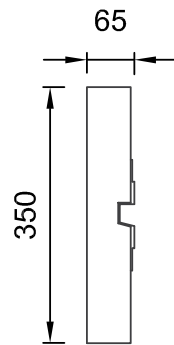

Art.Nr.:FNXABW

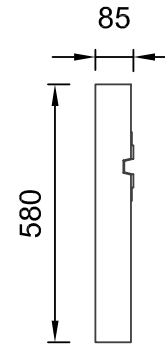

Art.Nr.:FNXACA

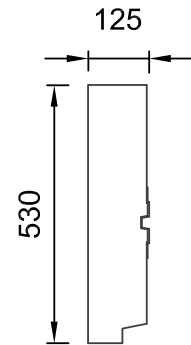

Art.Nr.:FNXACE



QR-Code einfach scannen und
Austrotherm Materialisten-Generator
online nutzen.

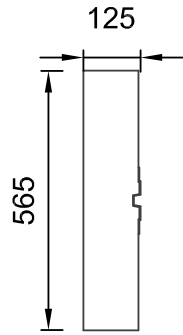

Art.Nr.: FNXACF

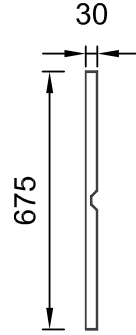

Art.Nr.: FNXACJ

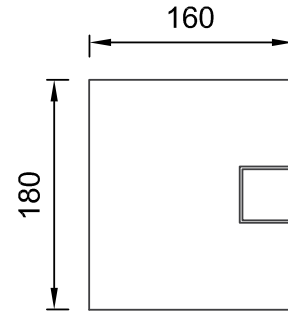

Art.Nr.: FNXACN

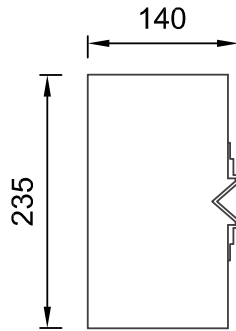

Art.Nr.: FNXACG

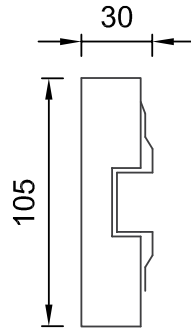

Art.Nr.: FNXACK

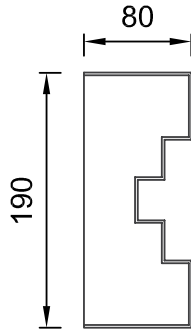

Art.Nr.: FNXACH

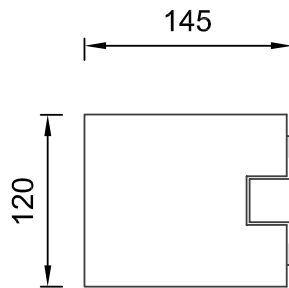

Art.Nr.: FNXACL

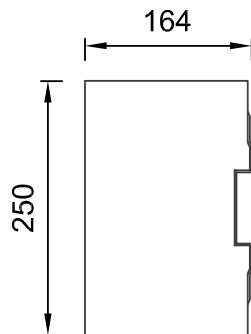

Art.Nr.: FNXACI

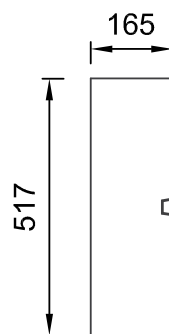

Art.Nr.: FNXACM



QR-Code einfach scannen und
Austrotherm Materialisten-Generator
online nutzen.

Austrotherm Sohlbankprofil

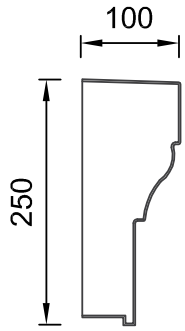

Art.Nr.:FSXAAA

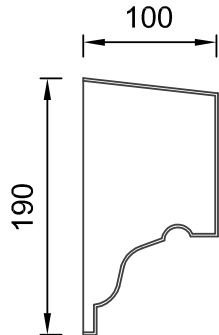

Art.Nr.:FSXAAF

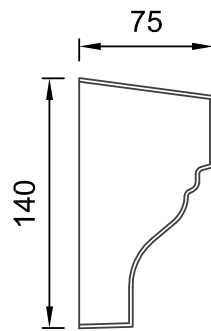

Art.Nr.:FSXAAJ

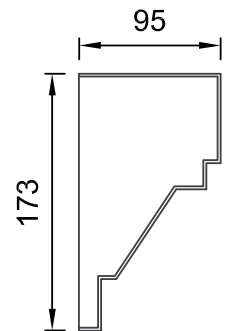

Art.Nr.:FSXAAN

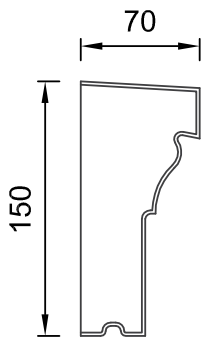

Art.Nr.:FSXAAB

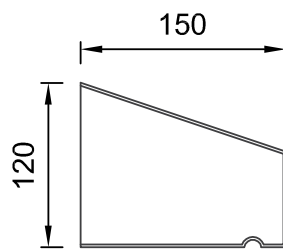

Art.Nr.:FSXAAG

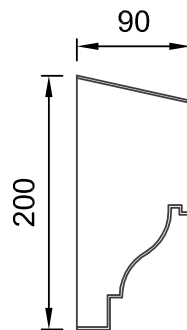

Art.Nr.:FSXAAK

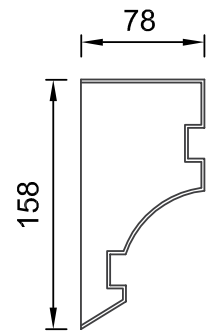

Art.Nr.:FSXAAO

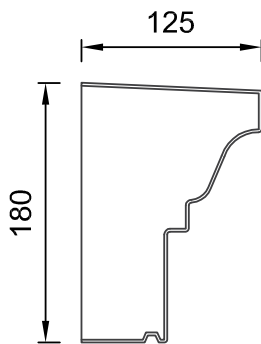

Art.Nr.:FSXAAD

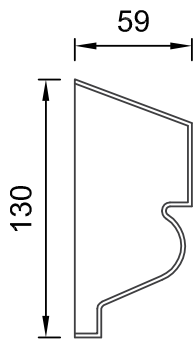

Art.Nr.:FSXA AH

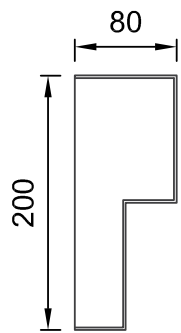

Art.Nr.:FSXAAL

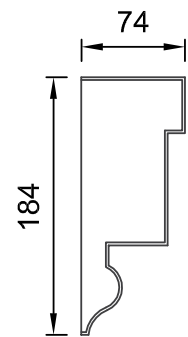

Art.Nr.:FSXAAP

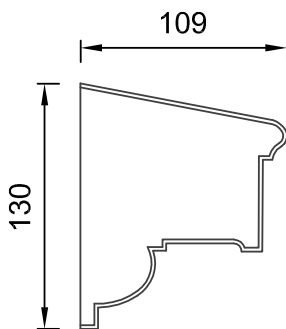

Art.Nr.:FSXA AE

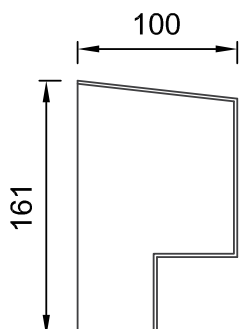

Art.Nr.:FSXA AI

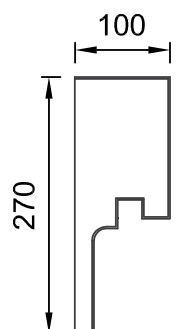

Art.Nr.:FSXA AM

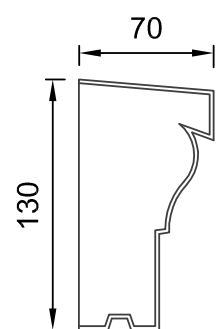

Art.Nr.:FSXA AQ



QR-Code einfach scannen und
Austrotherm Materiallisten-Generator
online nutzen.

Austrotherm Sohlbankprofil

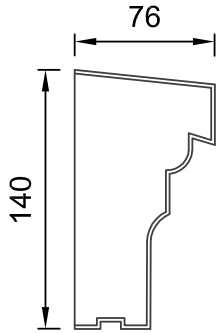

Art.Nr.:FSXAAR

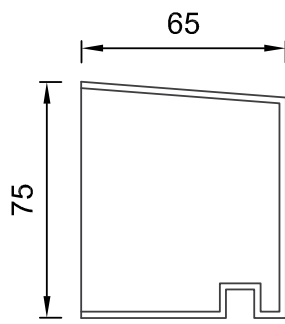

Art.Nr.:FSXAAV

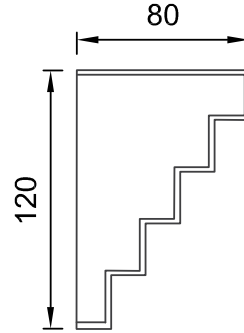

Art.Nr.:FSXABA

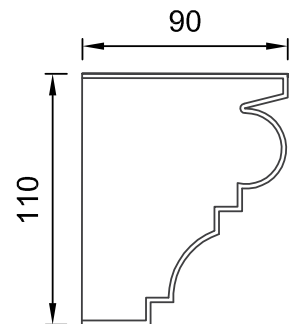

Art.Nr.:FSXABE

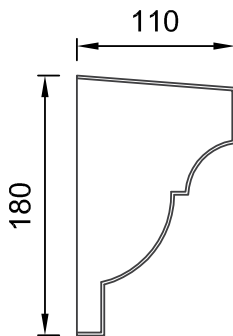

Art.Nr.:FSXAAS

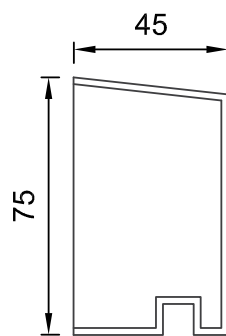

Art.Nr.:FSXAAW

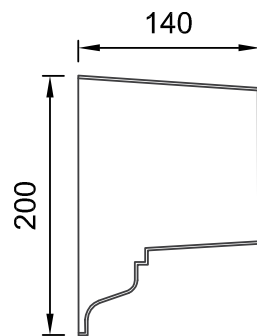

Art.Nr.:FSXABB

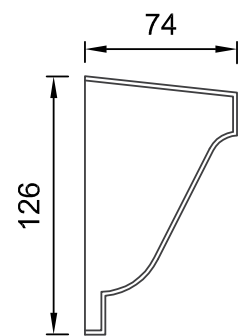

Art.Nr.:FSXABF

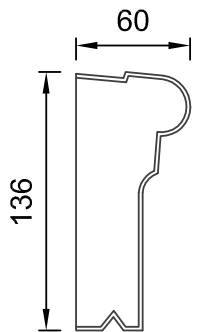

Art.Nr.:FSXAAT

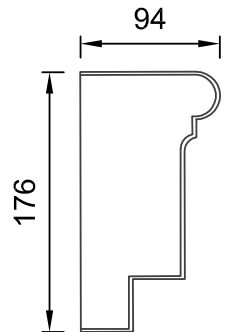

Art.Nr.:FSXAAX

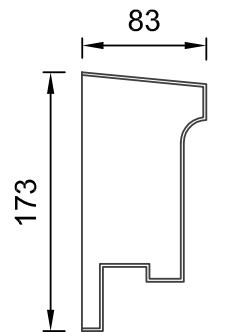

Art.Nr.:FSXABC

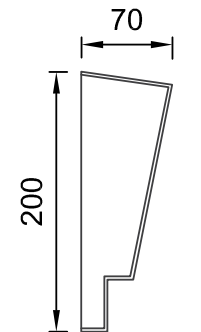

Art.Nr.:FSXABG

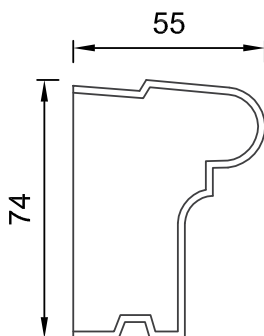

Art.Nr.:FSXAAU

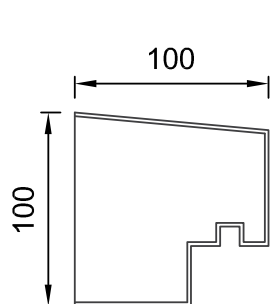

Art.Nr.:FSXAAZ

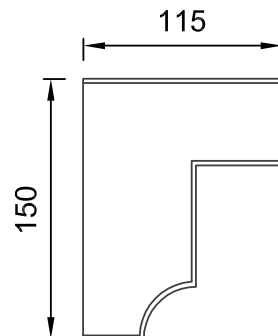

Art.Nr.:FSXABD

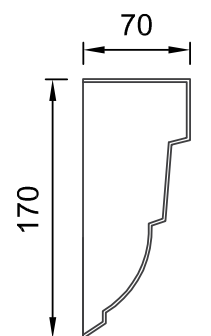

Art.Nr.:FSXABH



QR-Code einfach scannen und
Austrotherm Materialisten-Generator
online nutzen.

Austrotherm Sohlbankprofil

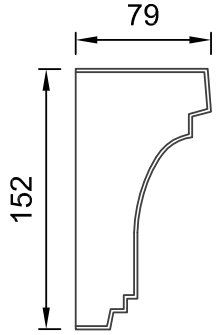

Art.Nr.:FSXABI

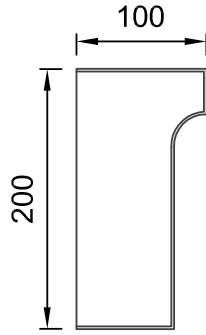

Art.Nr.:FSXABM

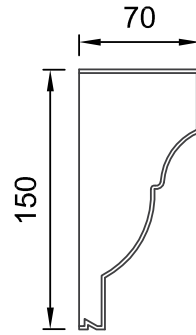

Art.Nr.:FSXABQ

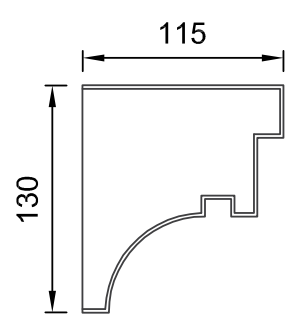

Art.Nr.:FSXABU

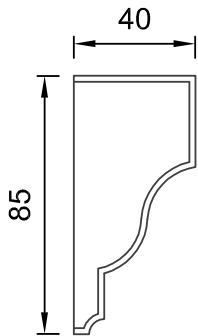

Art.Nr.:FSXABJ

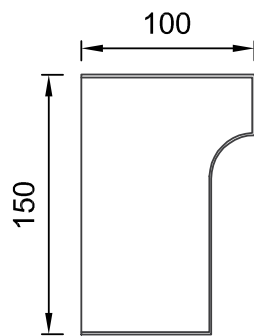

Art.Nr.:FSXABN

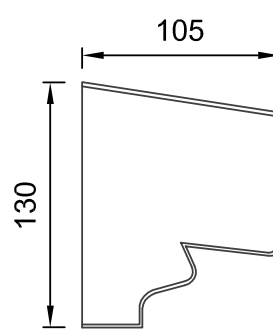

Art.Nr.:FSXABR

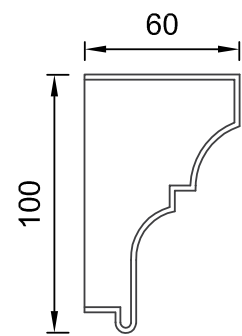

Art.Nr.:FSXABV

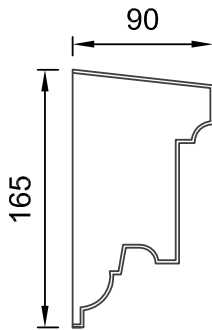

Art.Nr.:FSXABK

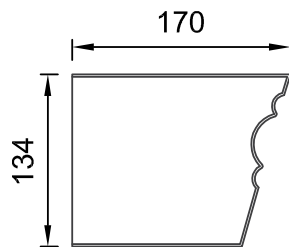

Art.Nr.:FSXABO

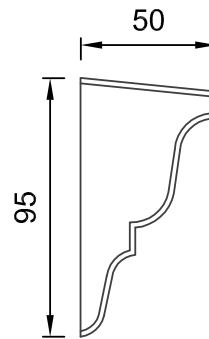

Art.Nr.:FSXABS

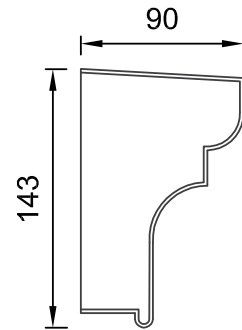

Art.Nr.:FSXABW

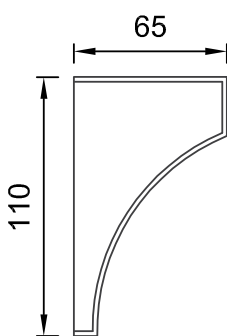

Art.Nr.:FSXABL

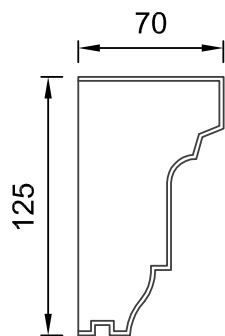

Art.Nr.:FSXABP

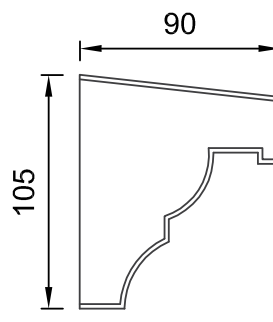

Art.Nr.:FSXABT

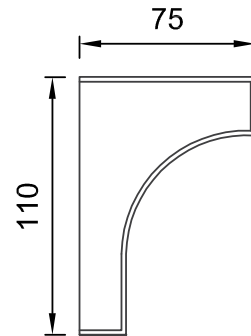

Art.Nr.:FSXABX



QR-Code einfach scannen und
Austrotherm Materialisten-Generator
online nutzen.

Austrotherm Sohlbankprofil

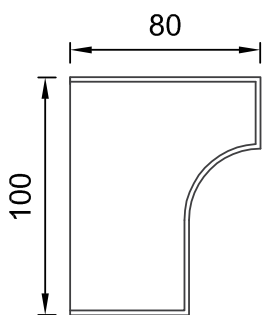

Art.Nr.:FSXABY

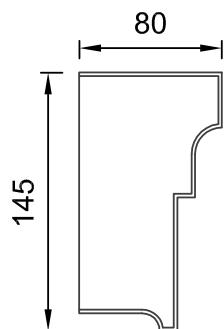

Art.Nr.:FSXACC

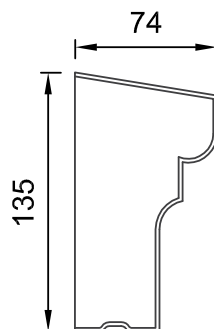

Art.Nr.:FSXACG

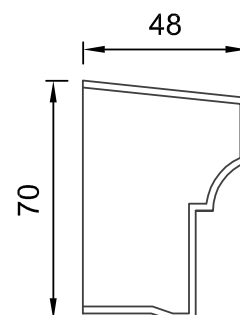

Art.Nr.:FSXACK

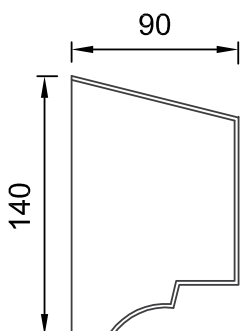

Art.Nr.:FSXABZ

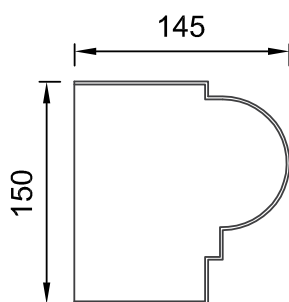

Art.Nr.:FSXACD

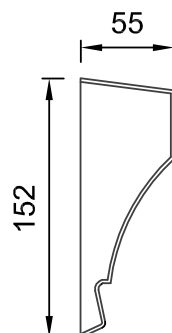

Art.Nr.:FSXACH

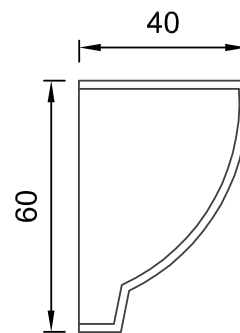

Art.Nr.:FSXACL

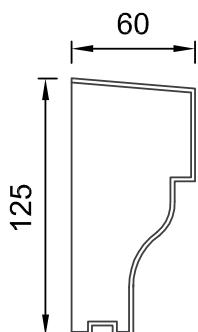

Art.Nr.:FSXACA

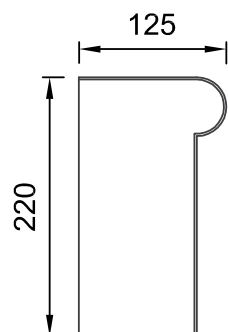

Art.Nr.:FSXACE

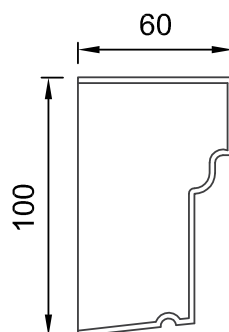

Art.Nr.:FSXACI

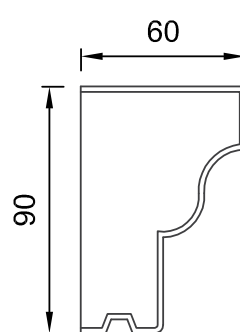

Art.Nr.:FSXACM

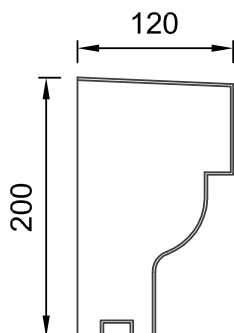

Art.Nr.:FSXACB

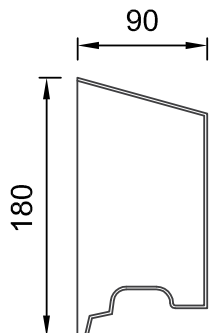

Art.Nr.:FSXACF

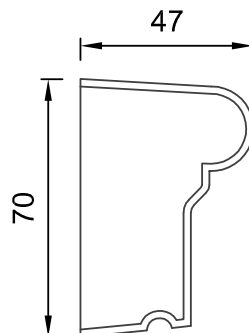

Art.Nr.:FSXACJ

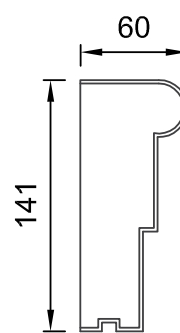

Art.Nr.:FSXACN



QR-Code einfach scannen und
Austrotherm Materiallist-Generator
online nutzen.

Austrotherm Sohlbankprofil

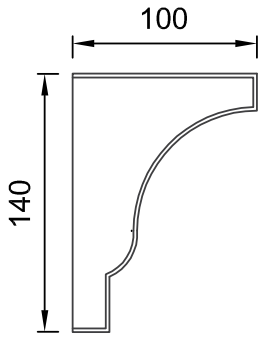

Art.Nr.:FSXACO

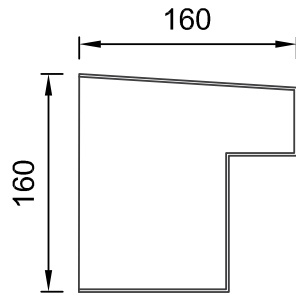

Art.Nr.:FSXACS

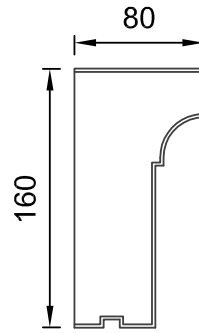

Art.Nr.:FSXACW

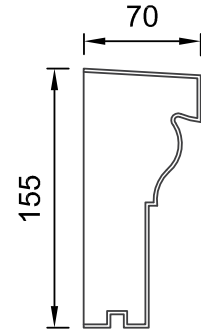

Art.Nr.:FSXADA

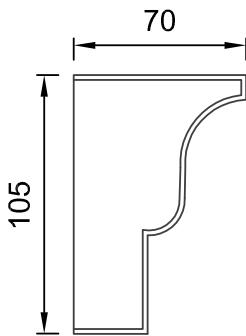

Art.Nr.:FSXACP

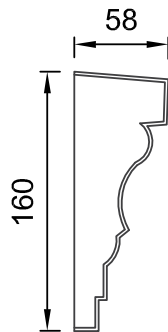

Art.Nr.:FSXACT

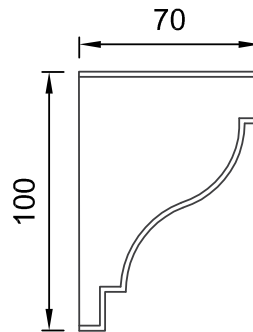

Art.Nr.:FSXACX

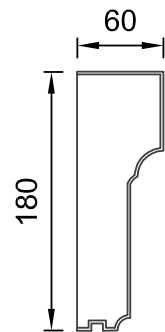

Art.Nr.:FSXADB

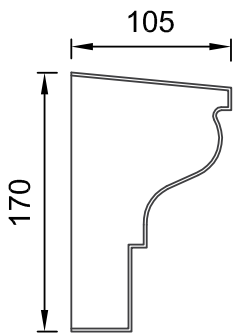

Art.Nr.:FSXACQ

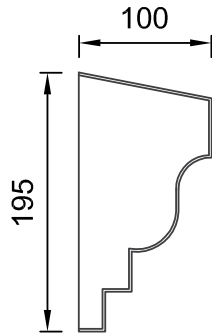

Art.Nr.:FSXACU

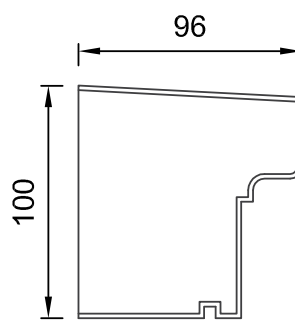

Art.Nr.:FSXACY

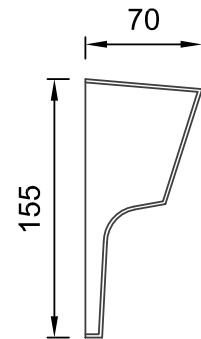

Art.Nr.:FSXADC

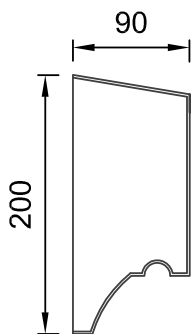

Art.Nr.:FSXACR

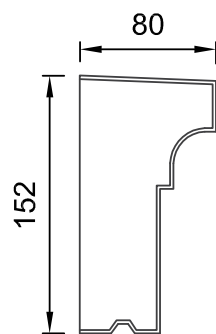

Art.Nr.:FSXACV

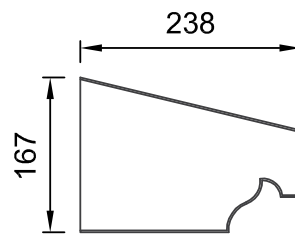

Art.Nr.:FSXACZ

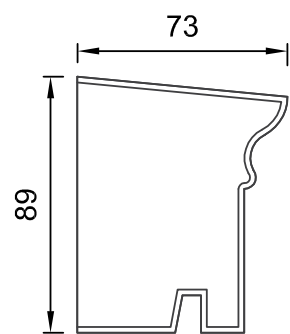

Art.Nr.:FSXADD



QR-Code einfach scannen und
Austrotherm Materialisten-Generator
online nutzen.

Austrotherm Sohlbankprofil

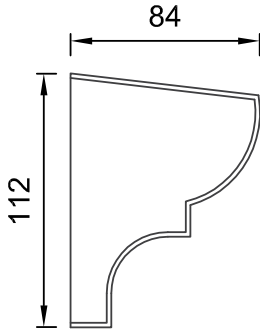

Art.Nr.:FSXADE

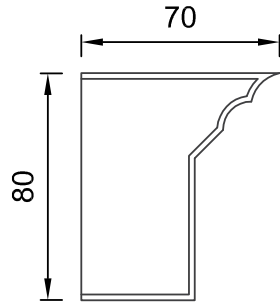

Art.Nr.:FSXADI

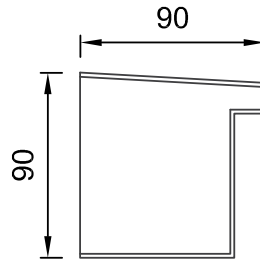

Art.Nr.:FSXADN

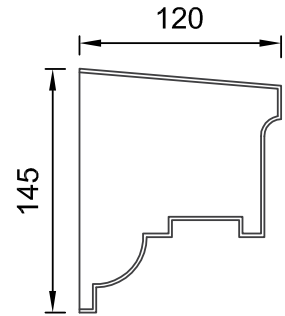

Art.Nr.:FSXADR

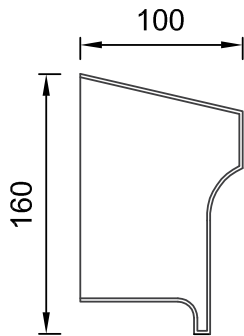

Art.Nr.:FSXADF

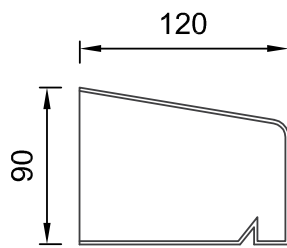

Art.Nr.:FSXADJ

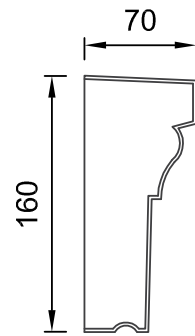

Art.Nr.:FSXADO

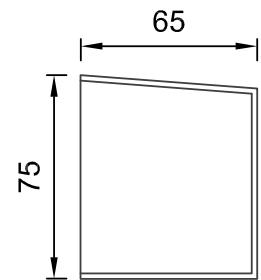

Art.Nr.:FSXADS

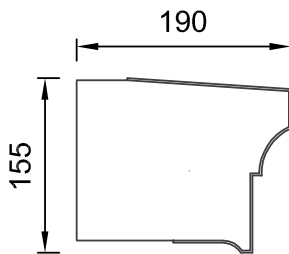

Art.Nr.:FSXADG

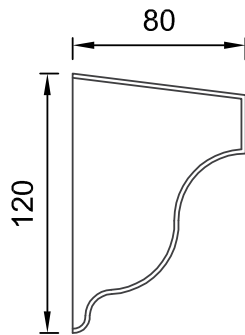

Art.Nr.:FSXADK

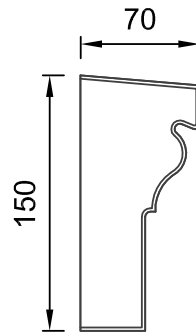

Art.Nr.:FSXADP

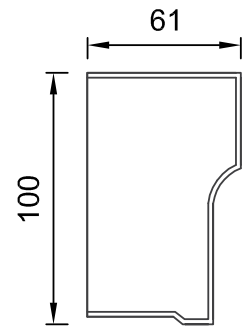

Art.Nr.:FSXADT

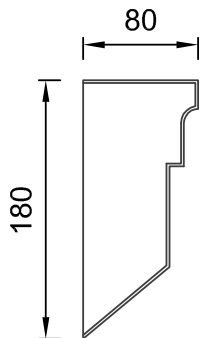

Art.Nr.:FSXADH

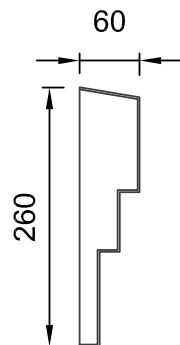

Art.Nr.:FSXADL

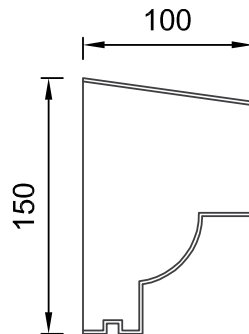

Art.Nr.:FSXADQ

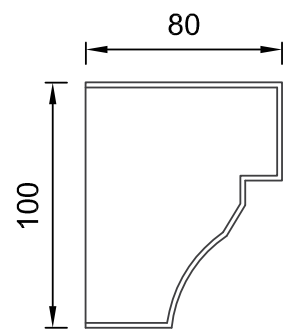

Art.Nr.:FSXADV



QR-Code einfach scannen und
Austrotherm Materiallisten-Generator
online nutzen.

Austrotherm Sohlbankprofil

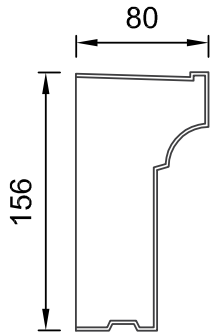

Art.Nr.:FSXADW

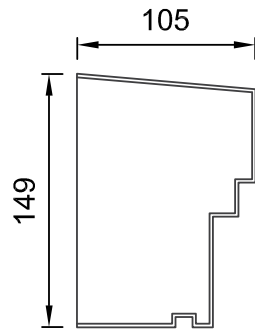

Art.Nr.:FSXAEM

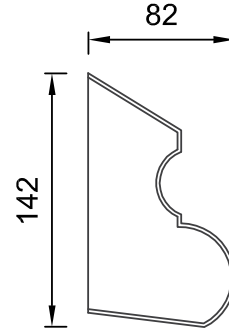

Art.Nr.:FSXAEV

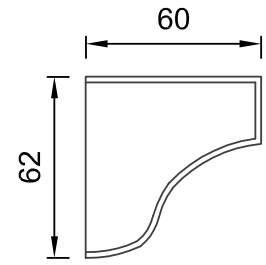

Art.Nr.:FSXAFM

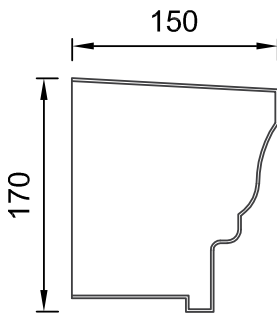

Art.Nr.:FSXADY

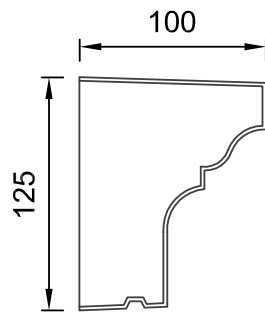

Art.Nr.:FSXAEP

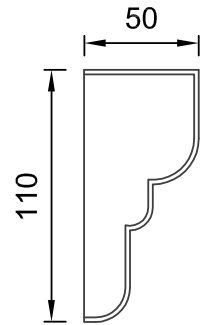

Art.Nr.:FSXAEX

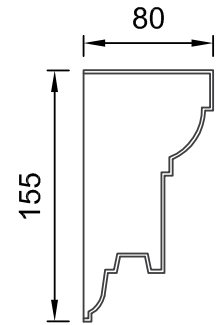

Art.Nr.:FSXAFO

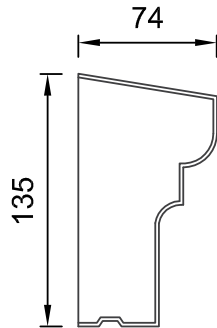

Art.Nr.:FSXAEH

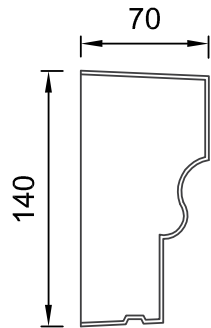

Art.Nr.:FSXAEQ

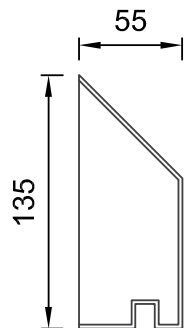

Art.Nr.:FSXAEZ

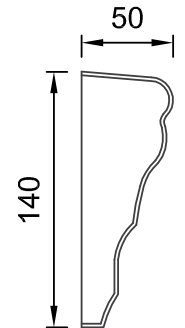

Art.Nr.:FSXAFP

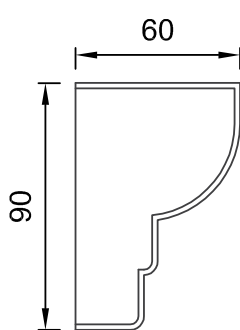

Art.Nr.:FSXAEJ

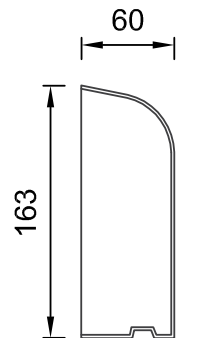

Art.Nr.:FSXAES

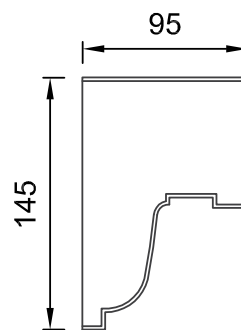

Art.Nr.:FSXAED

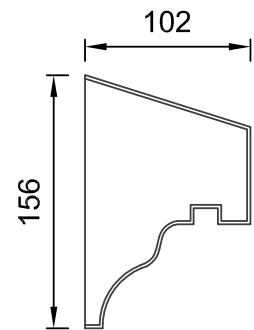

Art.Nr.:FSXAER



QR-Code einfach scannen und
Austrotherm Materialisten-Generator
online nutzen.

Austrotherm Sohlbankprofil

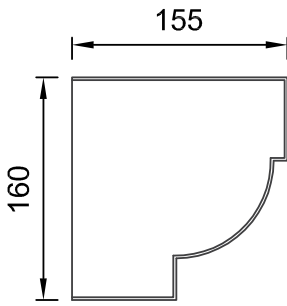

Art.Nr.:FSXAFS

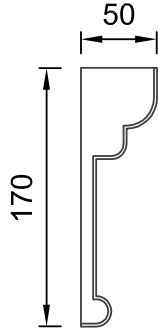

Art.Nr.:FSXAGG

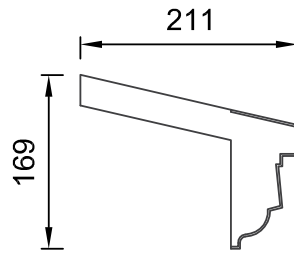

Art.Nr.:FSXAHB

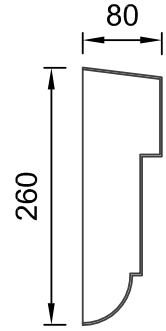

Art.Nr.:FSXAHP

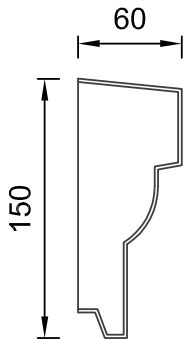

Art.Nr.:FSXAFT

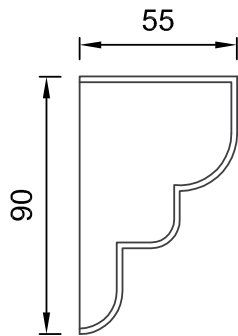

Art.Nr.:FSXAGH

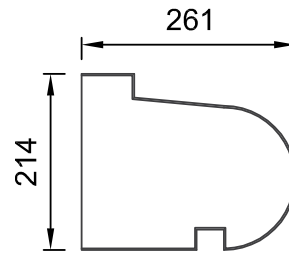

Art.Nr.:FSXAHD

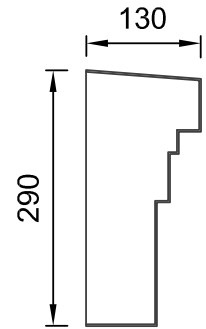

Art.Nr.:FSXAHS

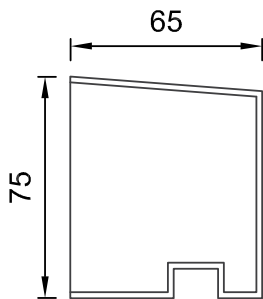

Art.Nr.:FSXAFV

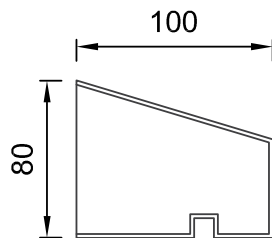

Art.Nr.:FSXAGM

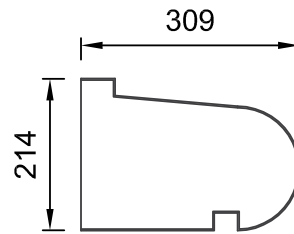

Art.Nr.:FSXAHE

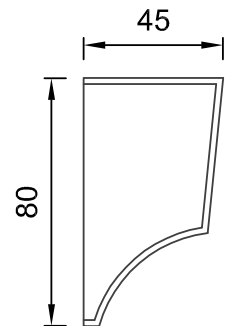

Art.Nr.:FSXAIJ

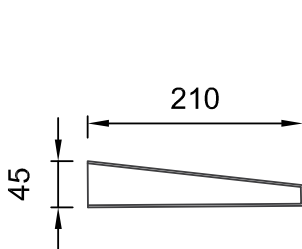

Art.Nr.:FSXAGF

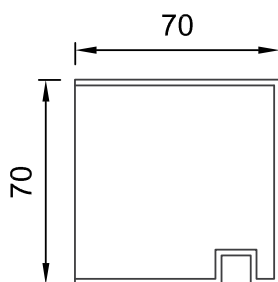

Art.Nr.:FSXAGS

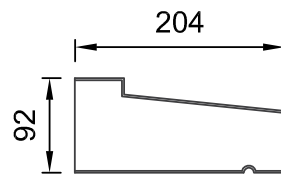

Art.Nr.:FSXAHF

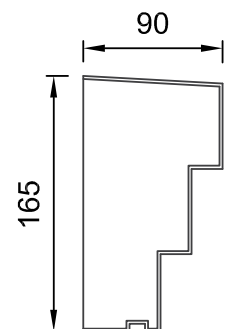

Art.Nr.:FSXAIY



QR-Code einfach scannen und
Austrotherm Materiallisten-Generator
online nutzen.

Austrotherm Sohlbankprofil

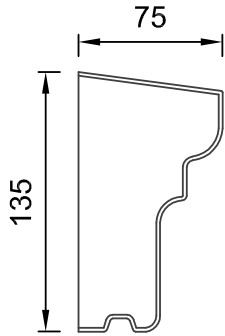

Art.Nr.:FSXAJA

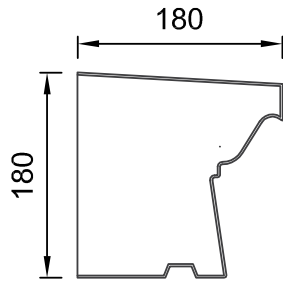

Art.Nr.:FSXALF

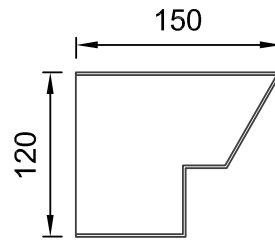

Art.Nr.:FSXANF

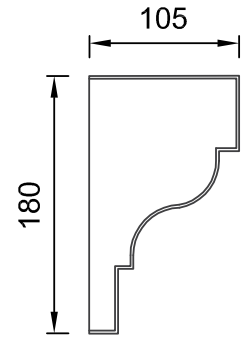

Art.Nr.:FSXAOZ

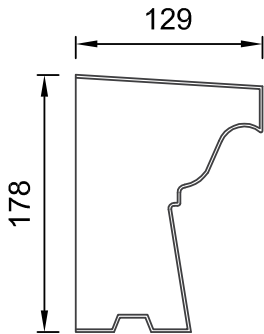

Art.Nr.:FSXAJB

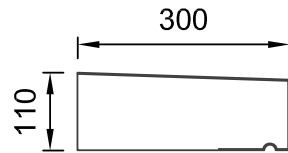

Art.Nr.:FSXALG

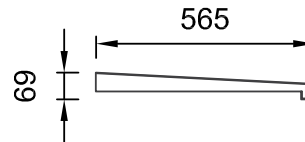

Art.Nr.:FSXAOI

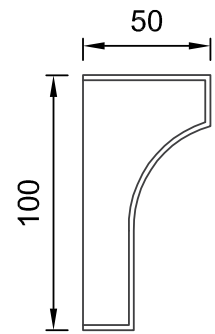

Art.Nr.:FSXAPD

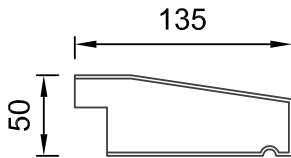

Art.Nr.:FSXAJG

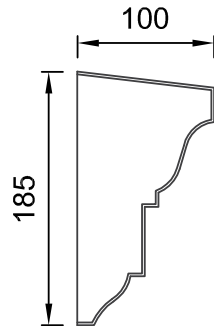

Art.Nr.:FSXALM

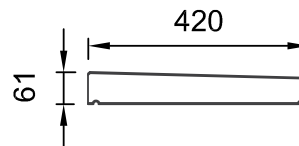

Art.Nr.:FSXAOJ

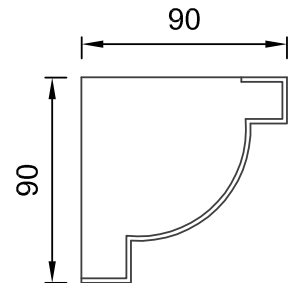

Art.Nr.:FSXAPJ

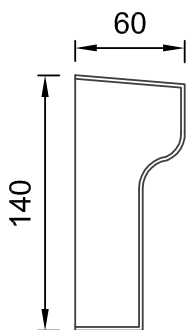

Art.Nr.:FSXAKH

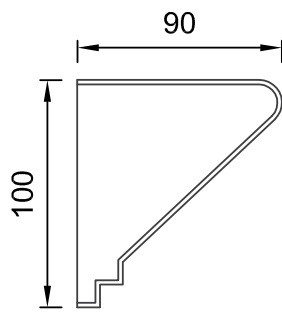

Art.Nr.:FSXAMH

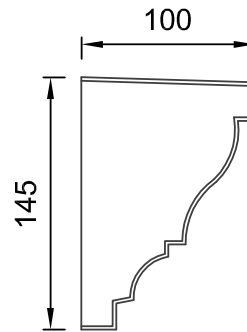

Art.Nr.:FSXAOO

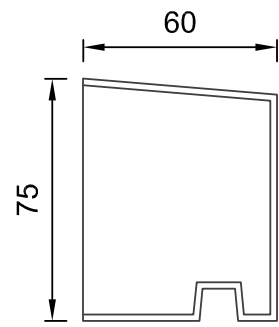

Art.Nr.:FSXAPM



QR-Code einfach scannen und
Austrotherm Materiallisten-Generator
online nutzen.

Austrotherm Sohlbankprofil

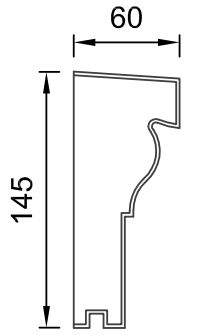

Art.Nr.:FSXAPN

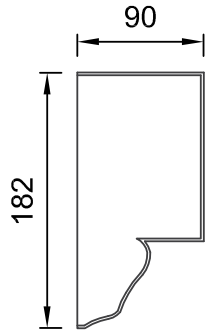

Art.Nr.:FSXAPY

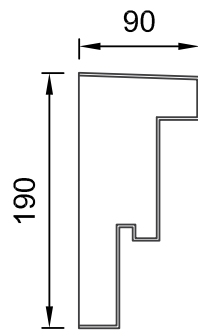

Art.Nr.:FSXARP

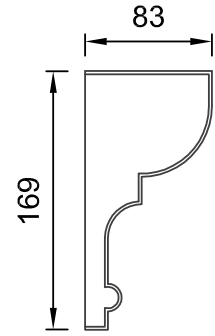

Art.Nr.:FSXARY

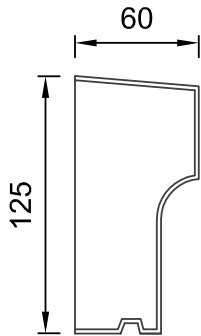

Art.Nr.:FSXAPO

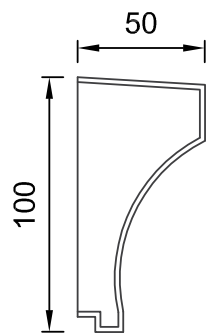

Art.Nr.:FSXAQS

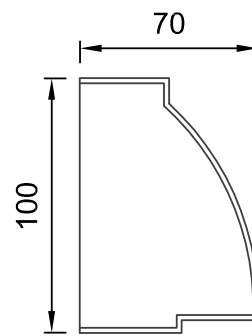

Art.Nr.:FSXARS

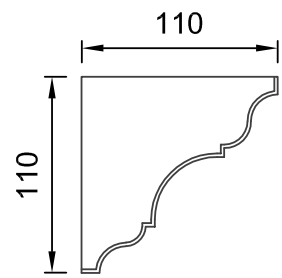

Art.Nr.:FSXASC

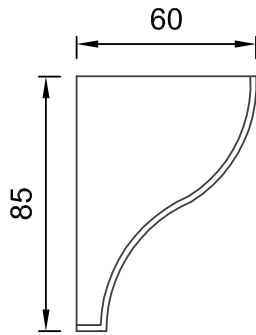

Art.Nr.:FSXAPP

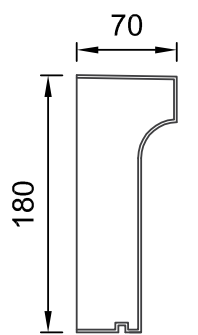

Art.Nr.:FSXAQT

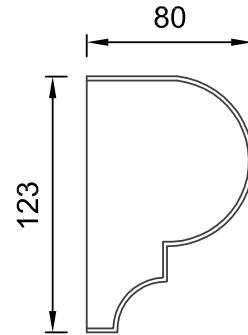

Art.Nr.:FSXARU

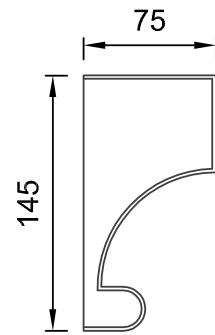

Art.Nr.:FSXASF

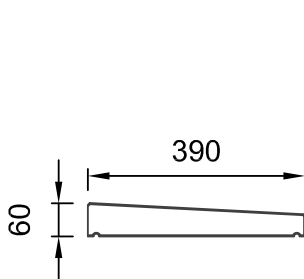

Art.Nr.:FSXAPT

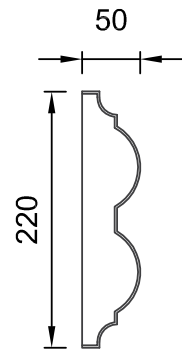

Art.Nr.:FSXARA

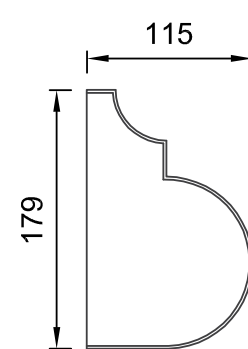

Art.Nr.:FSXARX

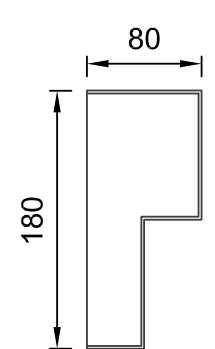

Art.Nr.:FSXASG



QR-Code einfach scannen und
Austrotherm Materiallisten-Generator
online nutzen.

Austrotherm Sohlbankprofil

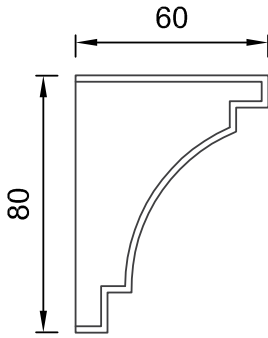

Art.Nr.:FSXASK

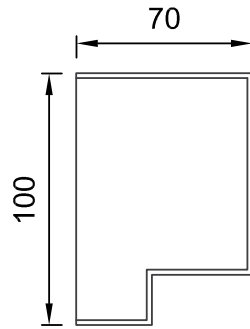

Art.Nr.:FSXAST

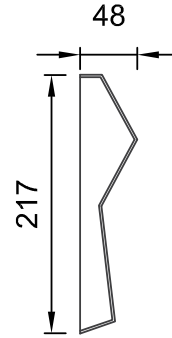

Art.Nr.:FSXATR

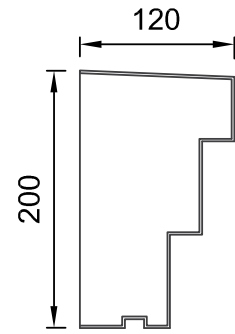

Art.Nr.:FSXATY

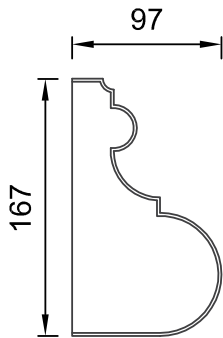

Art.Nr.:FSXASM

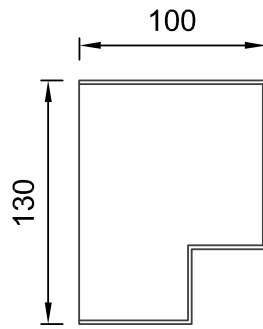

Art.Nr.:FSXASU

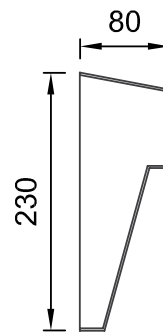

Art.Nr.:FSXATS

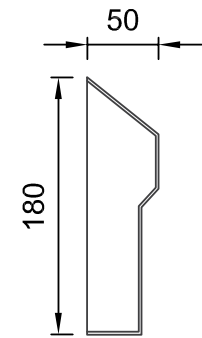

Art.Nr.:FSXAUJ

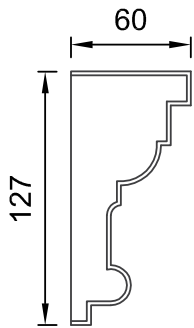

Art.Nr.:FSXASN

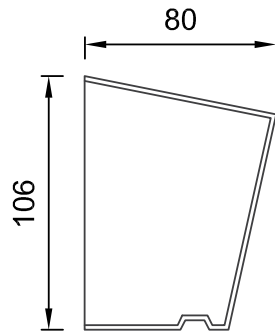

Art.Nr.:FSXATI

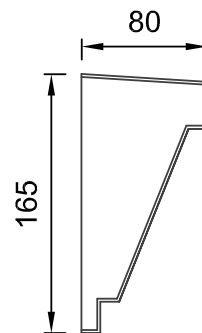

Art.Nr.:FSXATT

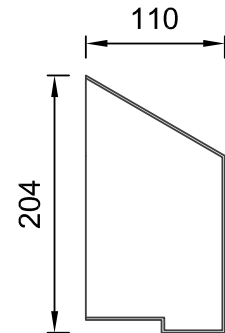

Art.Nr.:FSXAUN

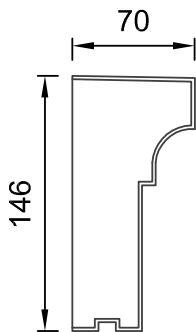

Art.Nr.:FSXASP

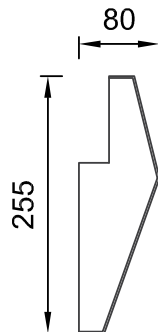

Art.Nr.:FSXATQ

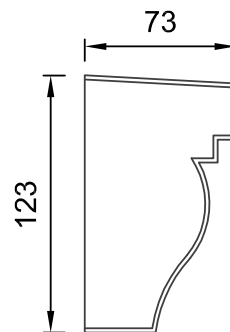

Art.Nr.:FSXATU

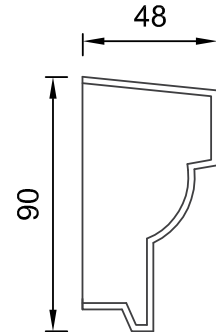

Art.Nr.:FSXAUO



QR-Code einfach scannen und
Austrotherm Materialisten-Generator
online nutzen.

Austrotherm Sohlbankprofil

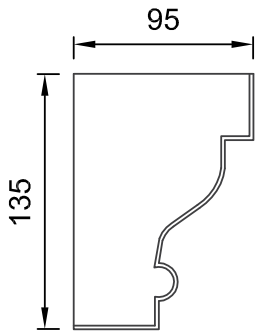

Art.Nr.:FSXAUP

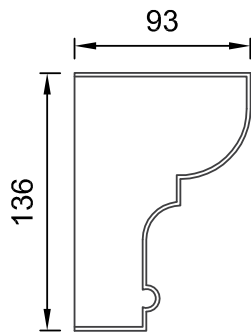

Art.Nr.:FSXAVK

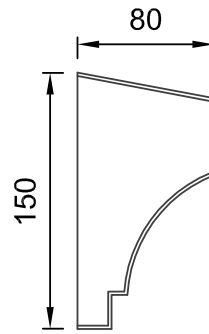

Art.Nr.:FSXAVO

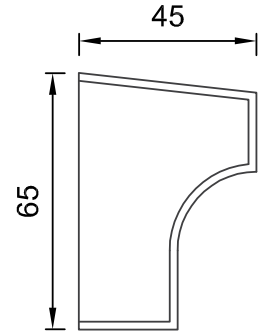

Art.Nr.:FSXAVX

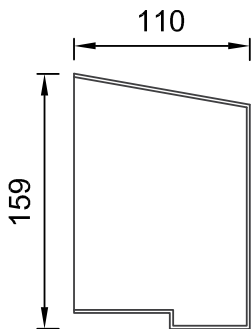

Art.Nr.:FSXAUR

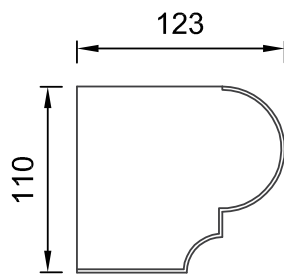

Art.Nr.:FSXAVL

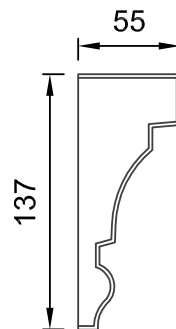

Art.Nr.:FSXAVT

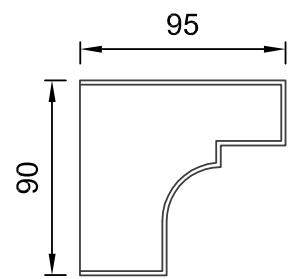

Art.Nr.:FSXAVY

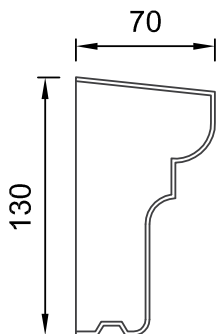

Art.Nr.:FSXAUV

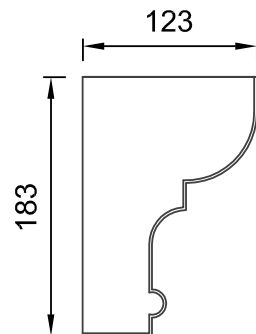

Art.Nr.:FSXAVM

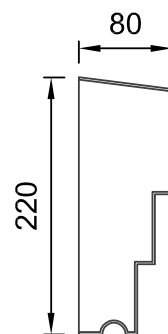

Art.Nr.:FSXAVV

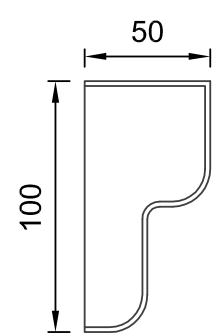

Art.Nr.:FSXAVZ

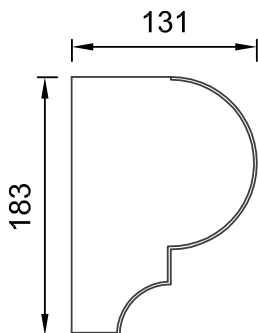

Art.Nr.:FSXAVJ

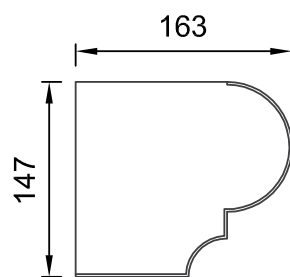

Art.Nr.:FSXAVN

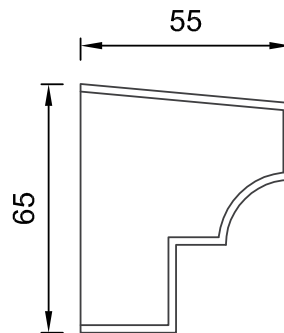

Art.Nr.:FSXAVW

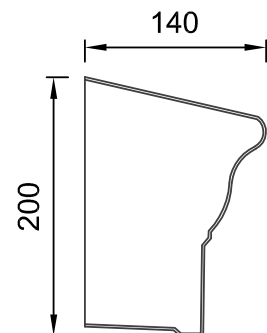

Art.Nr.:FSXAWB



QR-Code einfach scannen und
Austrotherm Materiallisten-Generator
online nutzen.

Austrotherm Sohlbankprofil

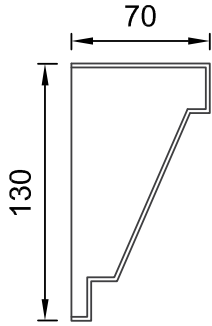

Art.Nr.:FSXAWL

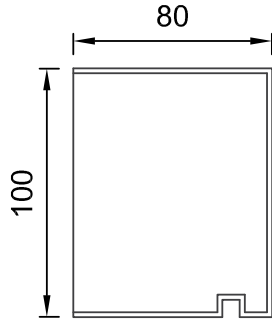

Art.Nr.:FSXAWY

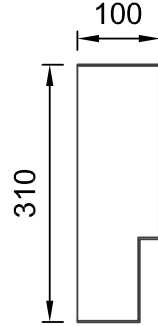

Art.Nr.:FSXAXE

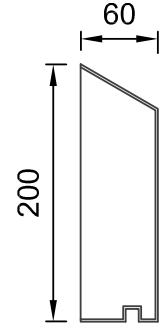

Art.Nr.:FSXAXR

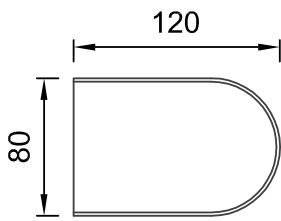

Art.Nr.:FSXAWO

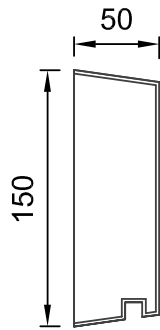

Art.Nr.:FSXAXB

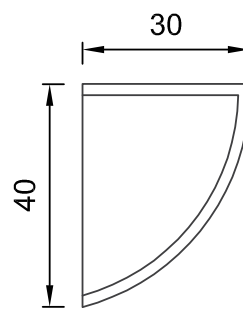

Art.Nr.:FSXAXF

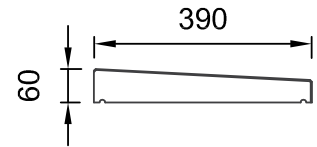

Art.Nr.:FSXAXX

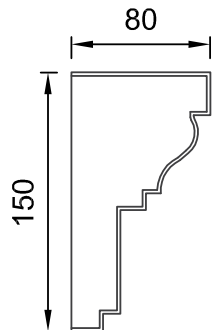

Art.Nr.:FSXAWR

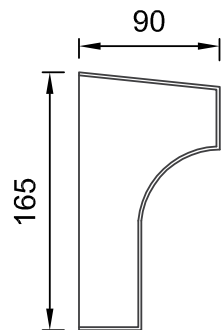

Art.Nr.:FSXAXC

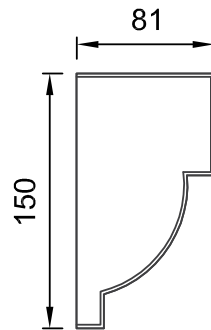

Art.Nr.:FSXAXK

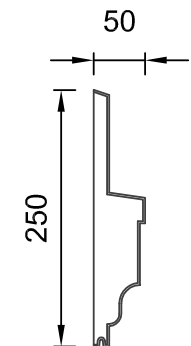

Art.Nr.:FSXAYC

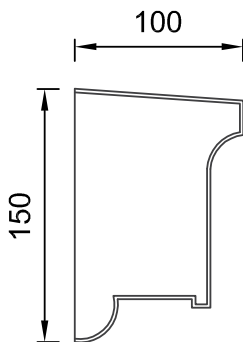

Art.Nr.:FSXAWS

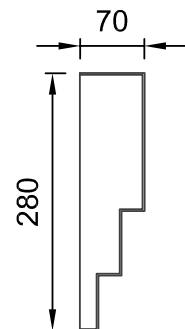

Art.Nr.:FSXAXD

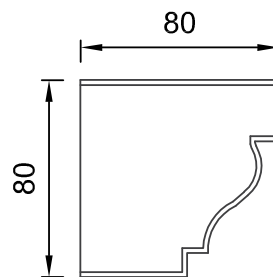

Art.Nr.:FSXAXQ

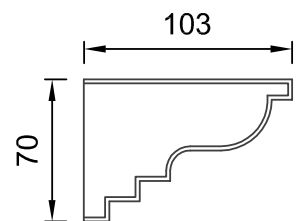

Art.Nr.:FSXAYD



QR-Code einfach scannen und
Austrotherm Materialisten-Generator
online nutzen.

Austrotherm Sohlbankprofil

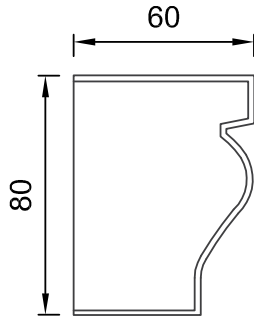

Art.Nr.:FSXAYH

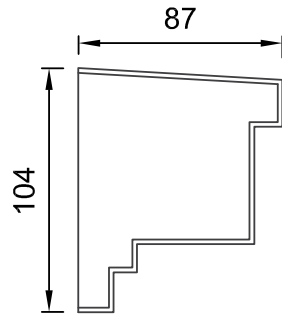

Art.Nr.:FSXAYL

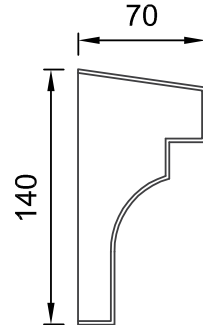

Art.Nr.:FSXAYT

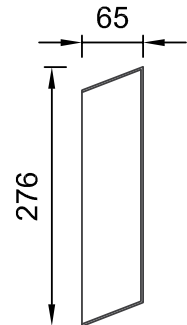

Art.Nr.:FSXAYZ

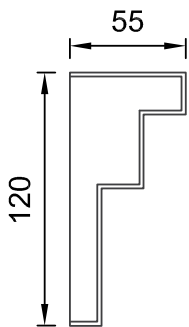

Art.Nr.:FSXAYI

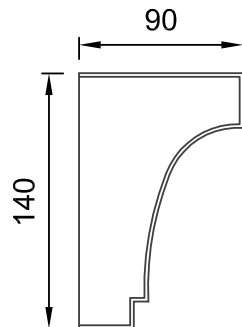

Art.Nr.:FSXAYO

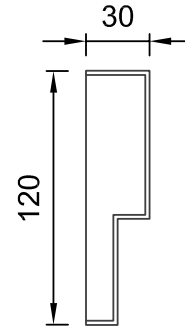

Art.Nr.:FSXAYU

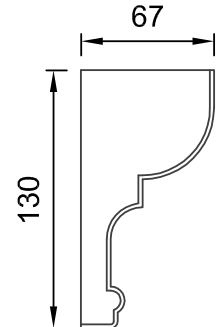

Art.Nr.:FSXAZB

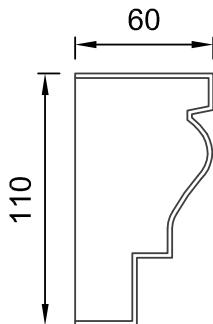

Art.Nr.:FSXAYJ

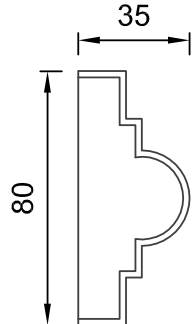

Art.Nr.:FSXAYR

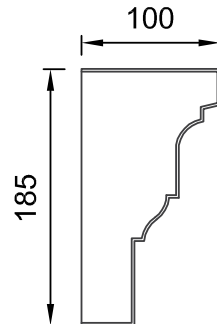

Art.Nr.:FSXAYW

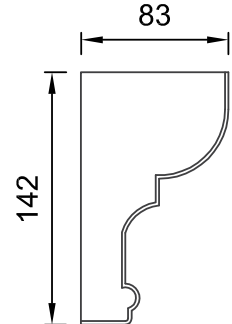

Art.Nr.:FSXAZC

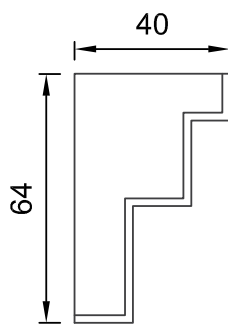

Art.Nr.:FSXAYK

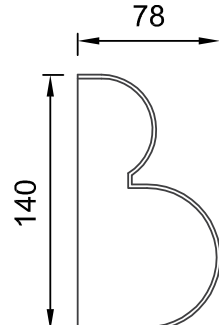

Art.Nr.:FSXAYS

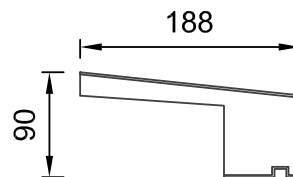

Art.Nr.:FSXAYX

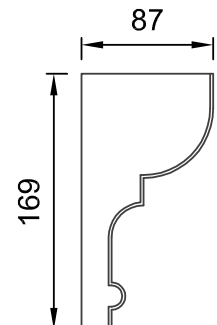

Art.Nr.:FSXAZD



QR-Code einfach scannen und
Austrotherm Materiallisten-Generator
online nutzen.

Austrotherm Sohlbankprofil

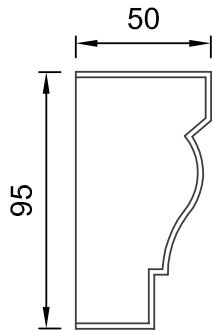

Art.Nr.:FSXAZE

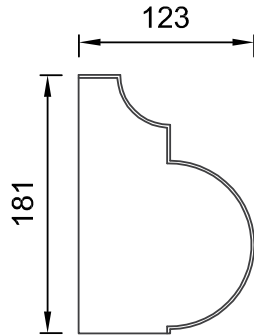

Art.Nr.:FSXAZL

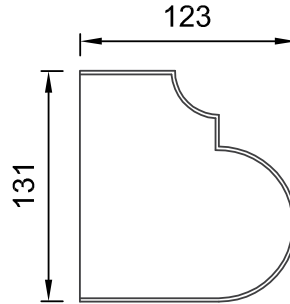

Art.Nr.:FSXAZP

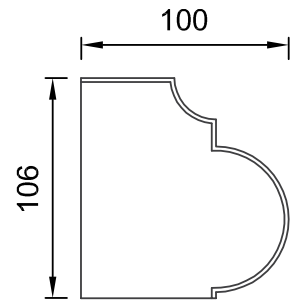

Art.Nr.:FSXAZT

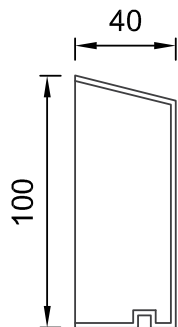

Art.Nr.:FSXAZH

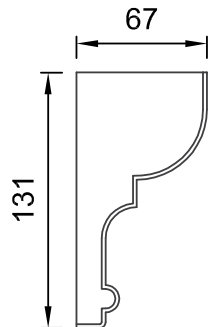

Art.Nr.:FSXAZM

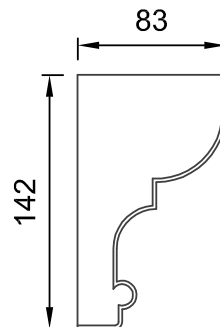

Art.Nr.:FSXAZQ

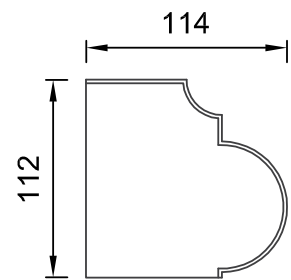

Art.Nr.:FSXAZU

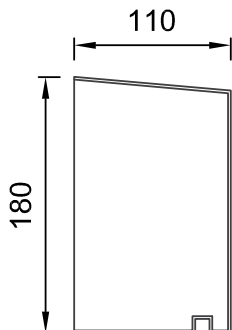

Art.Nr.:FSXAZI

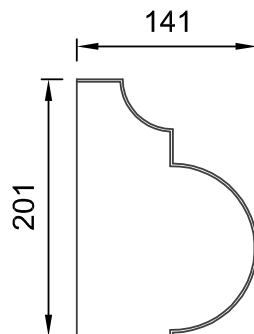

Art.Nr.:FSXAZN

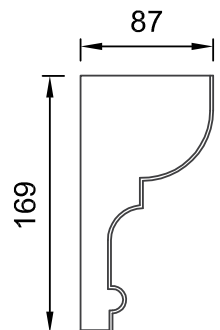

Art.Nr.:FSXAZR

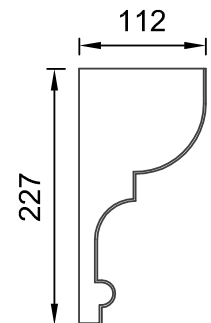

Art.Nr.:FSXAZV

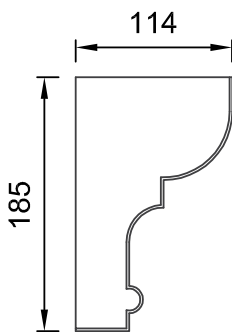

Art.Nr.:FSXAZK

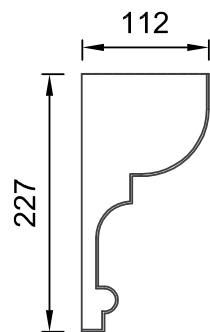

Art.Nr.:FSXAZO

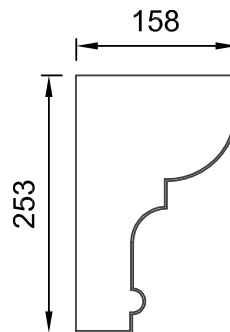

Art.Nr.:FSXAZS

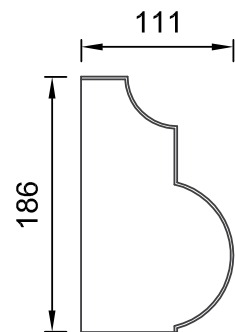

Art.Nr.:FSXAZW



QR-Code einfach scannen und
Austrotherm Materiallist-Generator
online nutzen.

Austrotherm Sohlbankprofil

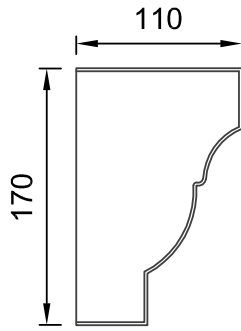

Art.Nr.:FSXBAA

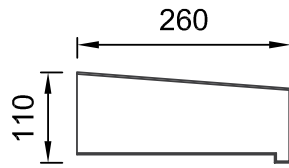

Art.Nr.:FSXBAJ

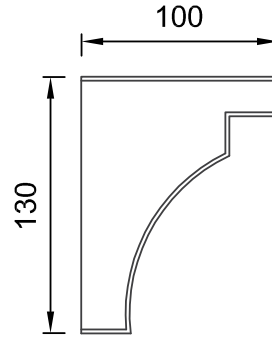

Art.Nr.:FSXBAS

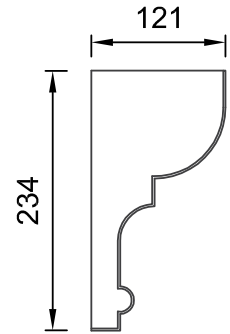

Art.Nr.:FSXBAX

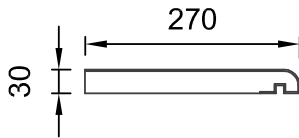

Art.Nr.:FSXBAB

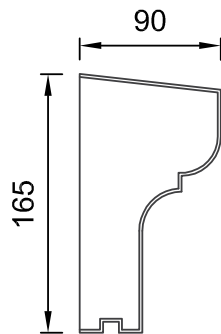

Art.Nr.:FSXBAL

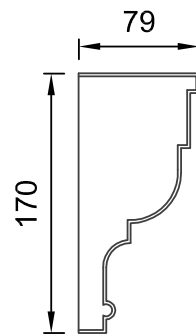

Art.Nr.:FSXBAU

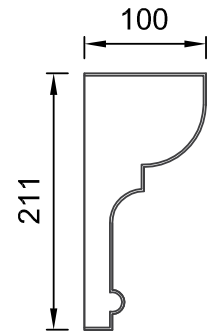

Art.Nr.:FSXBAY

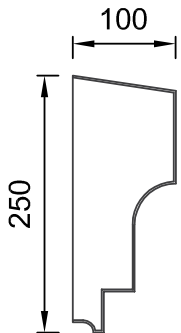

Art.Nr.:FSXBAF

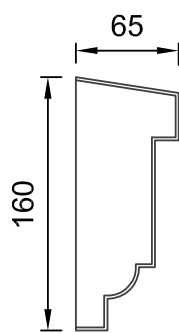

Art.Nr.:FSXBAP

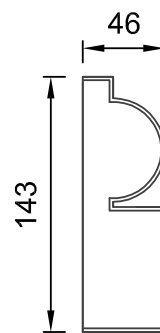

Art.Nr.:FSXBAV

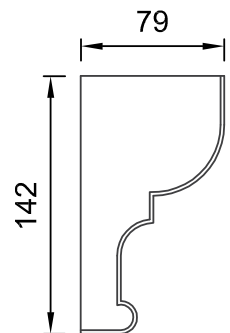

Art.Nr.:FSXBAZ

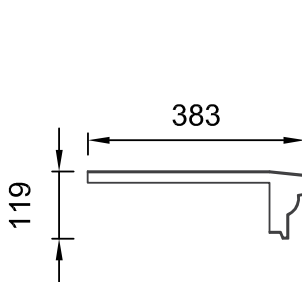

Art.Nr.:FSXBAL

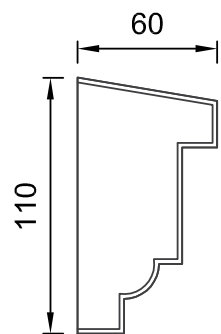

Art.Nr.:FSXBAR

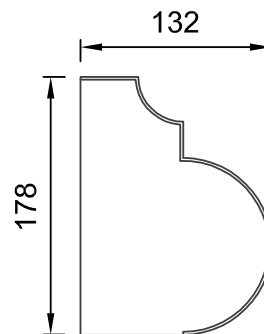

Art.Nr.:FSXBAW

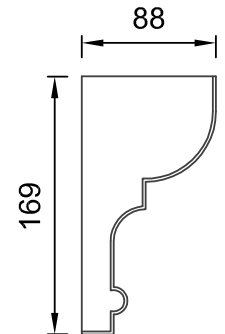

Art.Nr.:FSXBBA



QR-Code einfach scannen und
Austrotherm Materiallist-Generator
online nutzen.

Austrotherm Sohlbankprofil

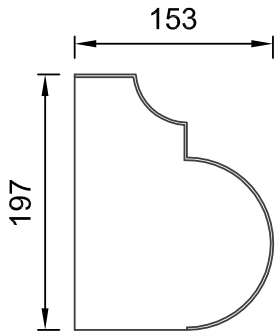

Art.Nr.:FSXBBB

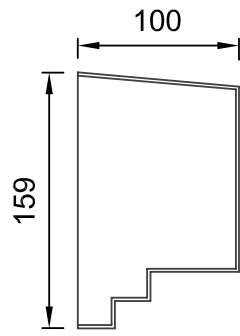

Art.Nr.:FSXBBJ

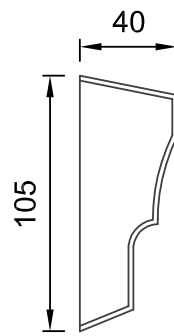

Art.Nr.:FSXBBX

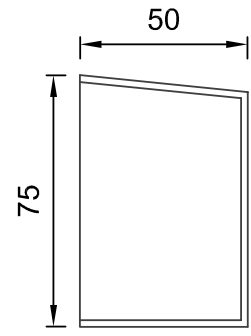

Art.Nr.:FSXBCL

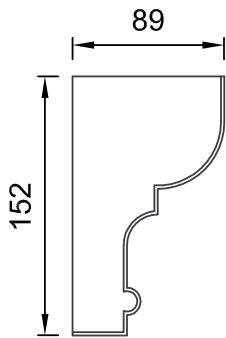

Art.Nr.:FSXBBC

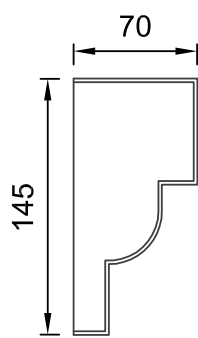

Art.Nr.:FSXBBN

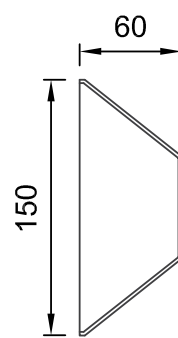

Art.Nr.:FSXBCE

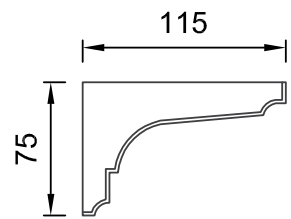

Art.Nr.:FSXBCK

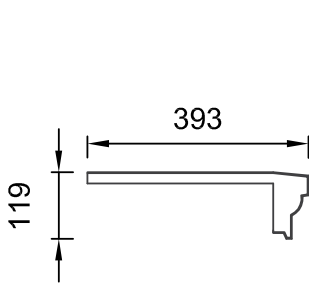

Art.Nr.:FSXBBH

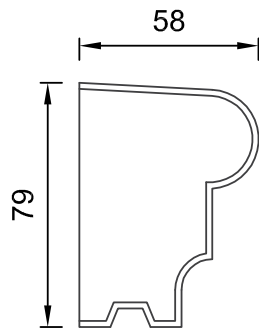

Art.Nr.:FSXBBO

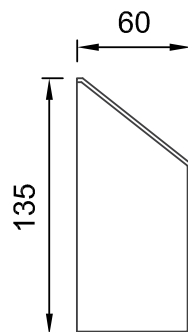

Art.Nr.:FSXBCE

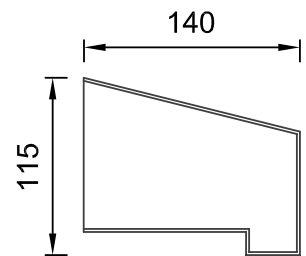

Art.Nr.:FSXBCL

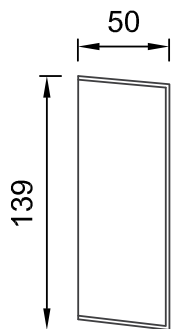

Art.Nr.:FSXBBI

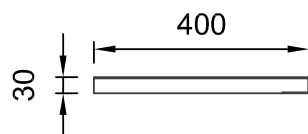

Art.Nr.:FSXBBP

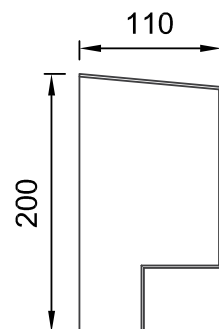

Art.Nr.:FSXBCH

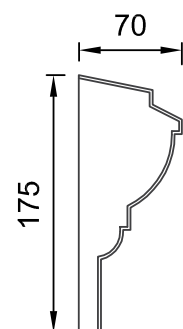

Art.Nr.:FSXBCE



QR-Code einfach scannen und
Austrotherm Materialisten-Generator
online nutzen.

Austrotherm Sohlbankprofil

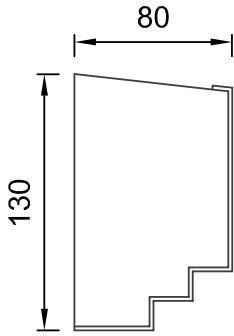

Art.Nr.:FSXBCN

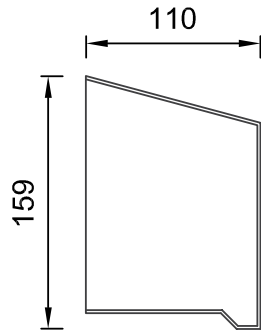

Art.Nr.:FSXBCU

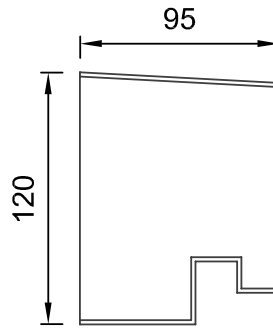

Art.Nr.:FSXBDE

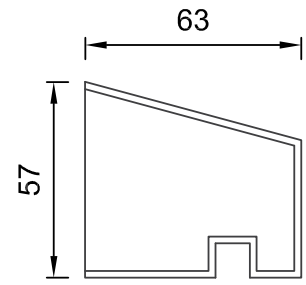

Art.Nr.:FSXBDN

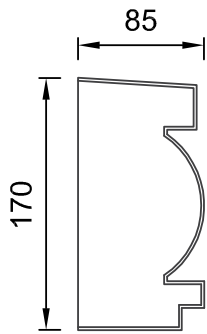

Art.Nr.:FSXBCQ

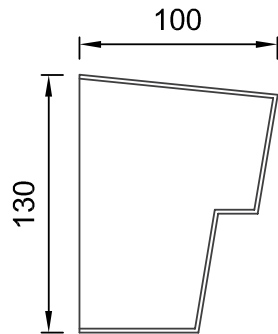

Art.Nr.:FSXBCX

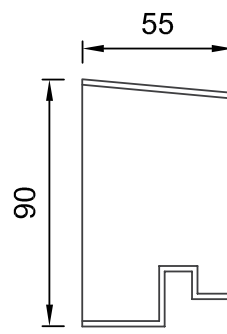

Art.Nr.:FSXBDF

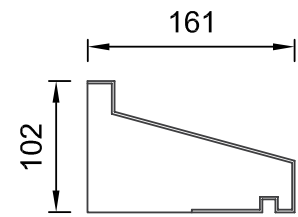

Art.Nr.:FSXBDO

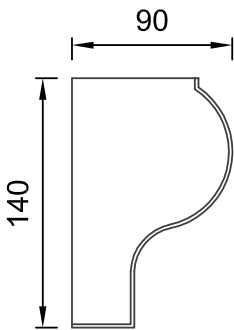

Art.Nr.:FSXBCR

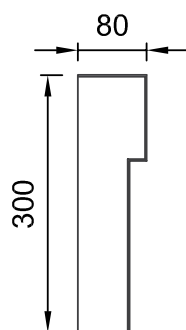

Art.Nr.:FSXBCY

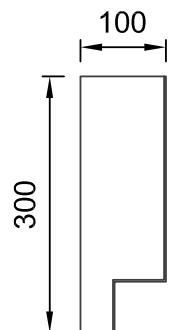

Art.Nr.:FSXBDK

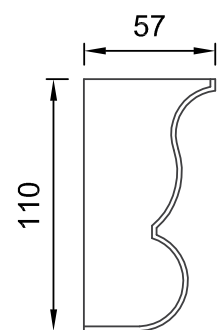

Art.Nr.:FSXBDQ

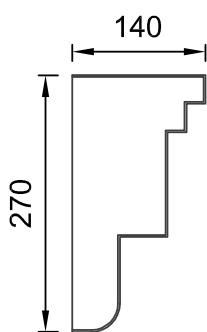

Art.Nr.:FSXBCS

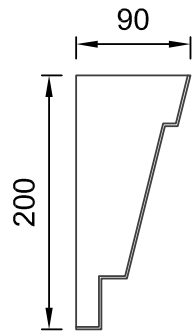

Art.Nr.:FSXBDB

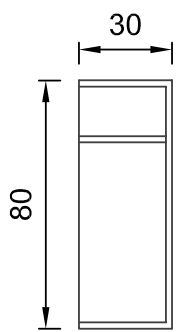

Art.Nr.:FSXBDM

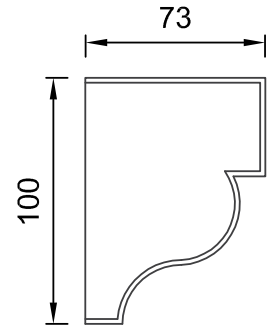

Art.Nr.:FSXBDR



QR-Code einfach scannen und
Austrotherm Materiallisten-Generator
online nutzen.

Austrotherm Sohlbankprofil

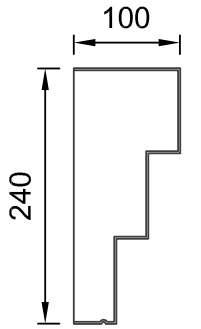

Art.Nr.:FSXBDO

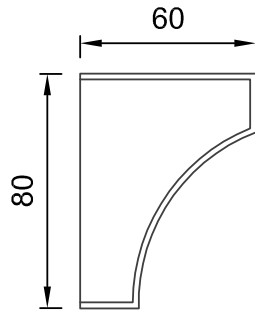

Art.Nr.:FSXBEC

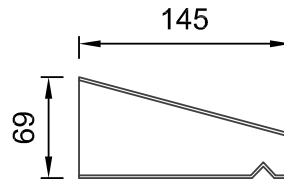

Art.Nr.:FSXBEJ

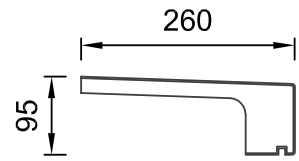

Art.Nr.:FSXBEW

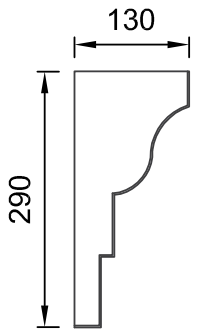

Art.Nr.:FSXBOW

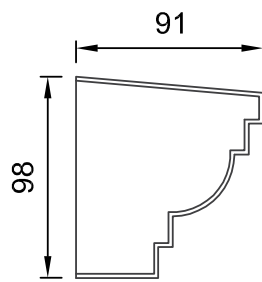

Art.Nr.:FSXBED

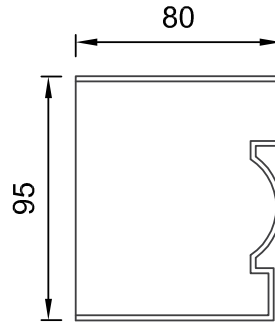

Art.Nr.:FSXBEK

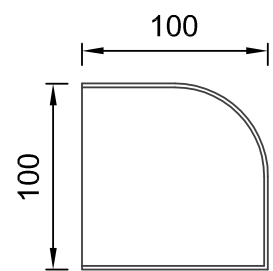

Art.Nr.:FSXBEX

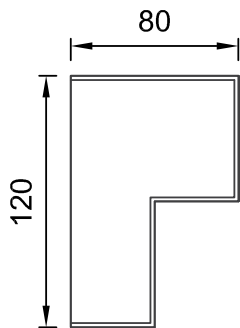

Art.Nr.:FSXBDZ

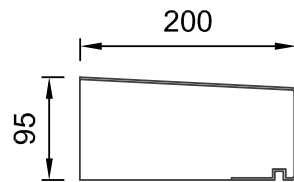

Art.Nr.:FSXBEP

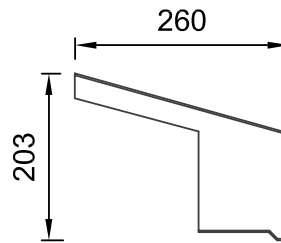

Art.Nr.:FSXBET

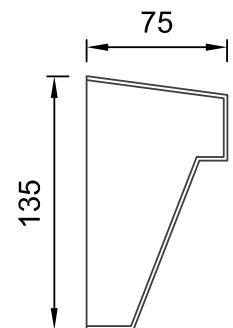

Art.Nr.:FSXBEZ

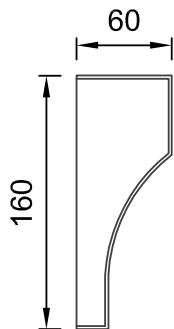

Art.Nr.:FSXBEB

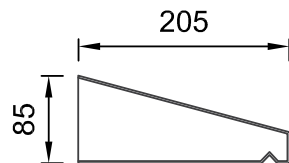

Art.Nr.:FSXBEI

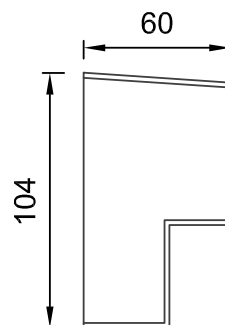

Art.Nr.:FSXBEU

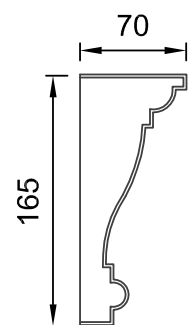

Art.Nr.:FSXBFB



QR-Code einfach scannen und
Austrotherm Materialisten-Generator
online nutzen.

Austrotherm Sohlbankprofil

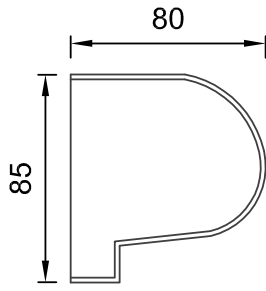

Art.Nr.:FSXBFE

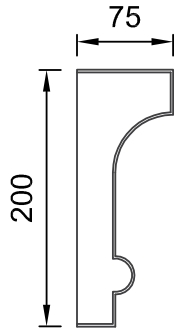

Art.Nr.:FSXBFL

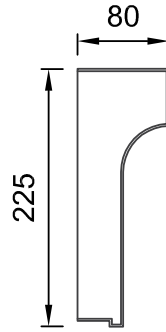

Art.Nr.:FSXBFT

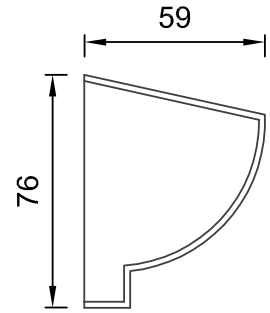

Art.Nr.:FSXBGD

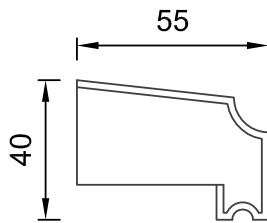

Art.Nr.:FSXBFF

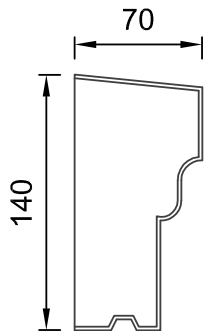

Art.Nr.:FSXBFQ

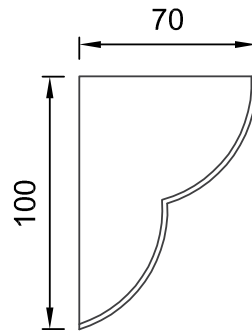

Art.Nr.:FSXBFW

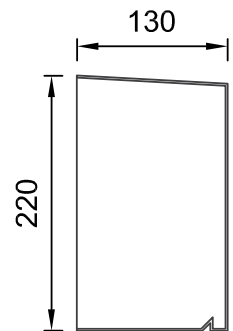

Art.Nr.:FSXBGG

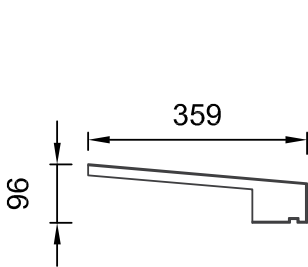

Art.Nr.:FSXBFI

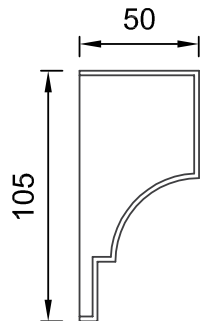

Art.Nr.:FSXBFR

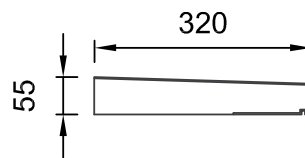

Art.Nr.:FSXBFY

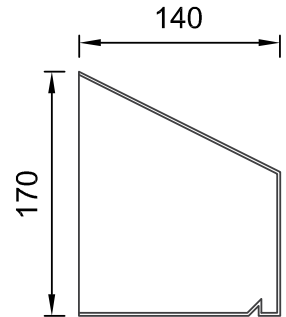

Art.Nr.:FSXBGH

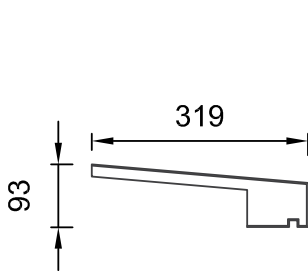

Art.Nr.:FSXBFK

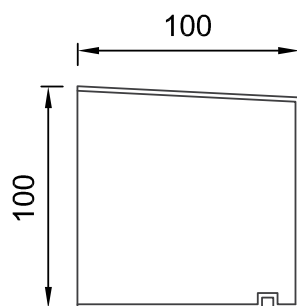

Art.Nr.:FSXBFS

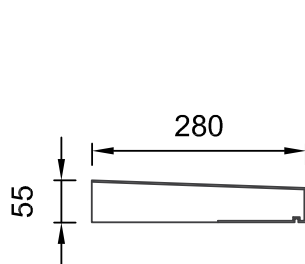

Art.Nr.:FSXBGB

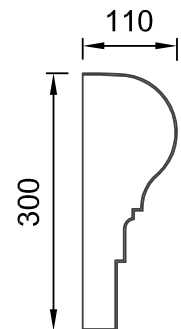

Art.Nr.:FSXBGL



QR-Code einfach scannen und
Austrotherm Materiallisten-Generator
online nutzen.

Austrotherm Sohlbankprofil

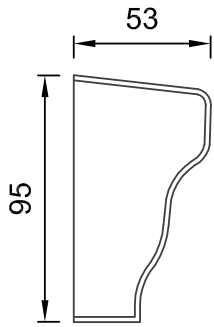

Art.Nr.:FSXBGM

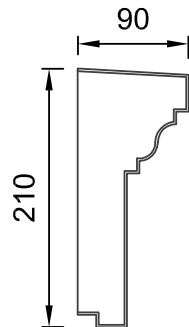

Art.Nr.:FSXBGY

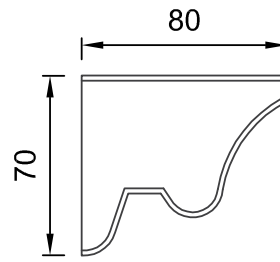

Art.Nr.:FSXBHH

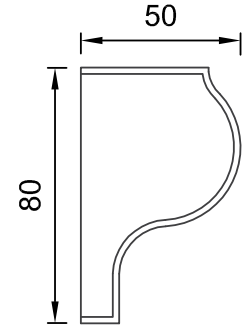

Art.Nr.:FSXBHL

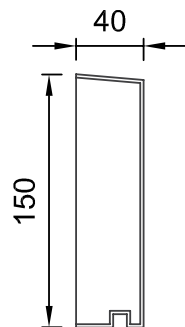

Art.Nr.:FSXBGR

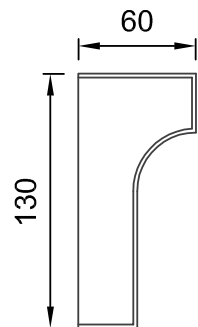

Art.Nr.:FSXBHE

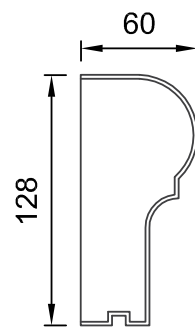

Art.Nr.:FSXBHI

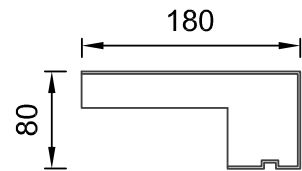

Art.Nr.:FSXBHM

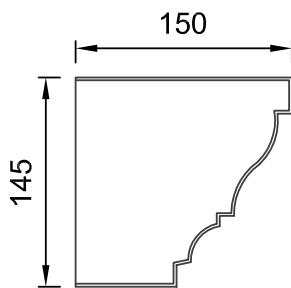

Art.Nr.:FSXBGT

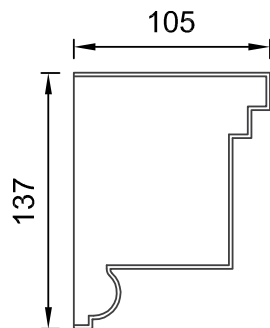

Art.Nr.:FSXBHF

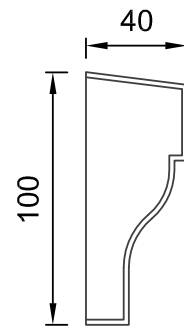

Art.Nr.:FSXBHJ

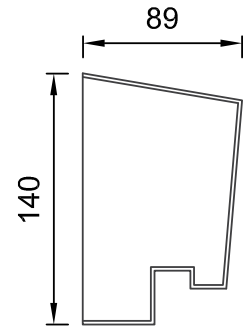

Art.Nr.:FSXBHN

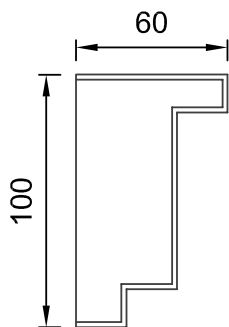

Art.Nr.:FSXBGU

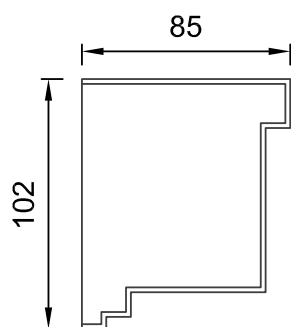

Art.Nr.:FSXBHG

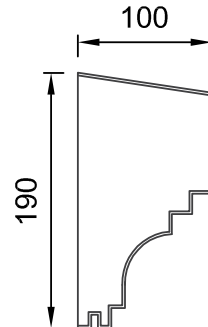

Art.Nr.:FSXBHK

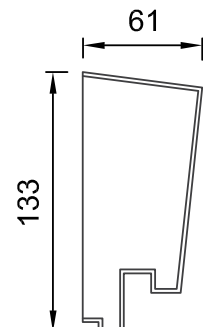

Art.Nr.:FSXBHO



QR-Code einfach scannen und
Austrotherm Materiallisten-Generator
online nutzen.

Austrotherm Sohlbankprofil

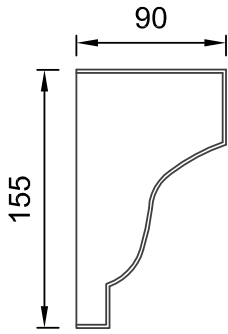

Art.Nr.:FSXBHP

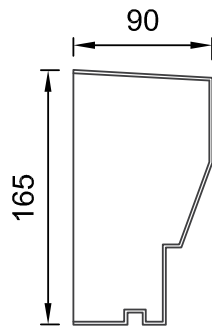

Art.Nr.:FSXBHT

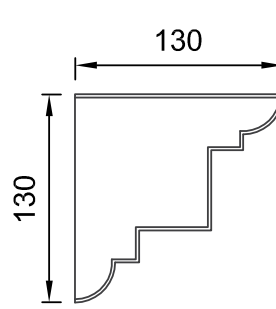

Art.Nr.:FSXBHX

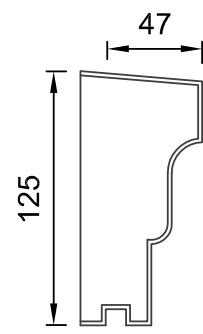

Art.Nr.:FSXBIB

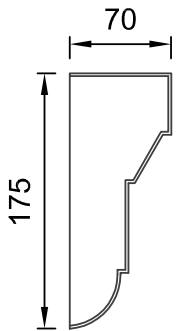

Art.Nr.:FSXBHQ

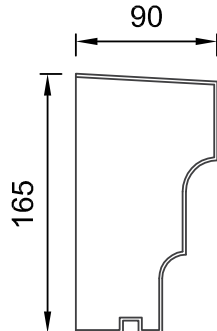

Art.Nr.:FSXBHU

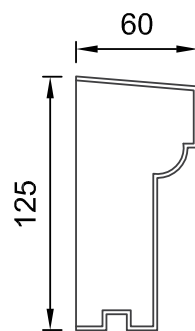

Art.Nr.:FSXBHY

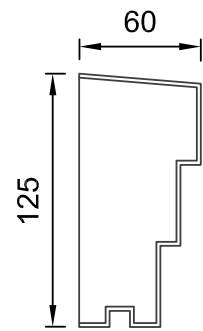

Art.Nr.:FSXBIC

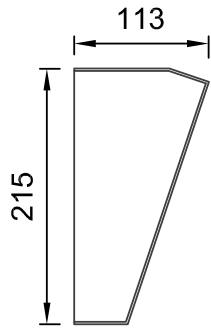

Art.Nr.:FSXBHR

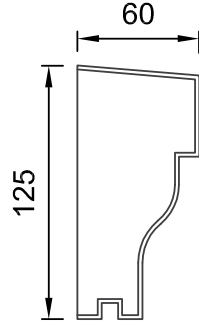

Art.Nr.:FSXBHV

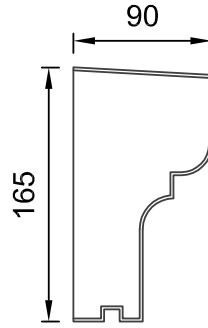

Art.Nr.:FSXBHZ

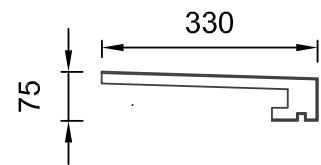

Art.Nr.:FSXBID

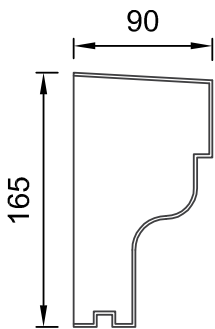

Art.Nr.:FSXBHS

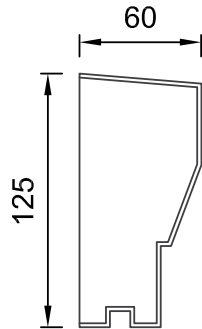

Art.Nr.:FSXBHW

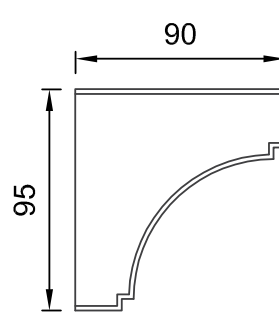

Art.Nr.:FSXBIA

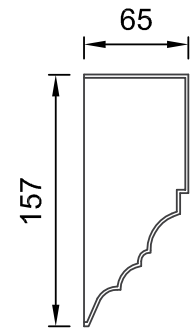

Art.Nr.:FSXBIE



QR-Code einfach scannen und
Austrotherm Materiallist-Generator
online nutzen.

Austrotherm Sohlbankprofil

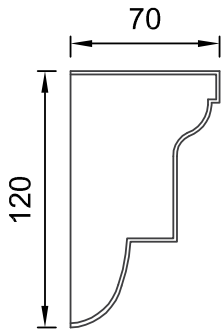

Art.Nr.:FSXBIF

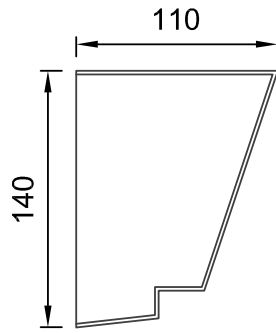

Art.Nr.:FSXBII

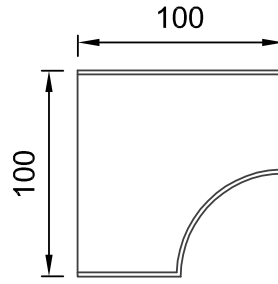

Art.Nr.:FSXBIN

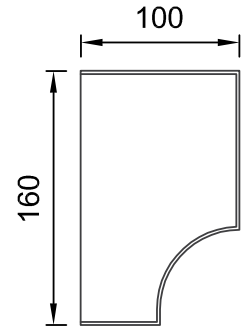

Art.Nr.:FSXBIR

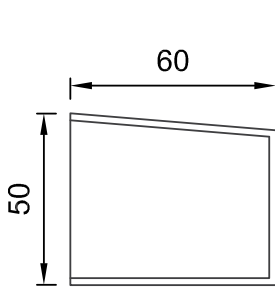

Art.Nr.:FSXBIG

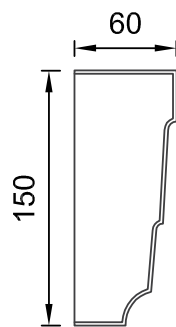

Art.Nr.:FSXBIIK

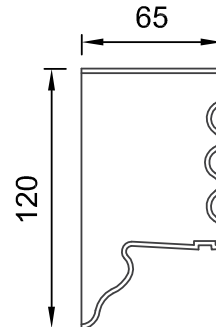

Art.Nr.:FSXBIO

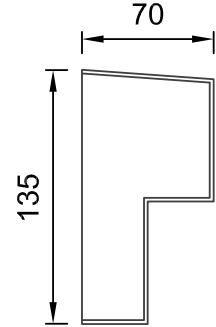

Art.Nr.:FSXBIS

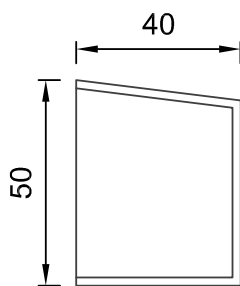

Art.Nr.:FSXBIIH

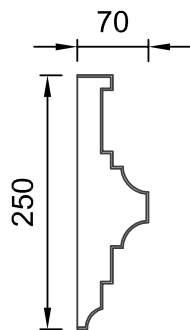

Art.Nr.:FSXBIL

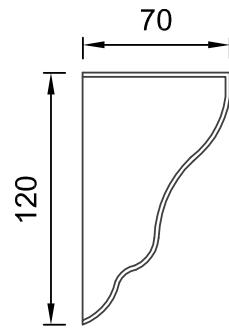

Art.Nr.:FSXBIP

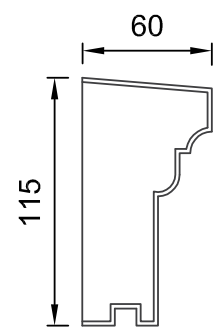

Art.Nr.:FSXBIT

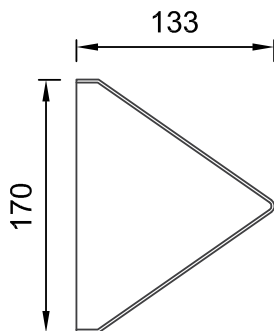

Art.Nr.:FSXBII

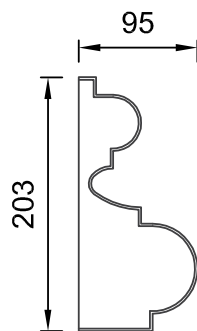

Art.Nr.:FSXBIM

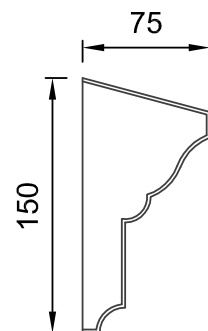

Art.Nr.:FSXBIIQ

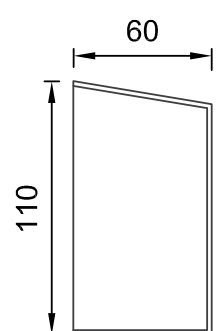

Art.Nr.:FSXBIIU



QR-Code einfach scannen und
Austrotherm Materiallisten-Generator
online nutzen.

Austrotherm Sohlbankprofil

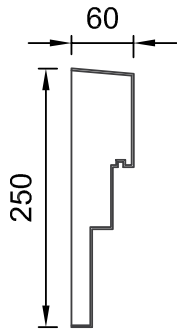

Art.Nr.:FSXBIV

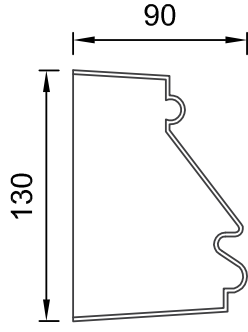

Art.Nr.:FSXBIZ

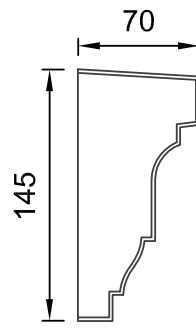

Art.Nr.:FSXBJD

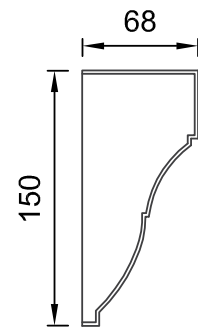

Art.Nr.:FSXBJH

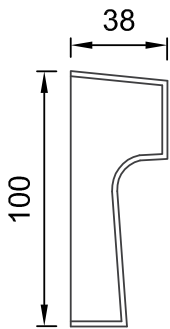

Art.Nr.:FSXBIV

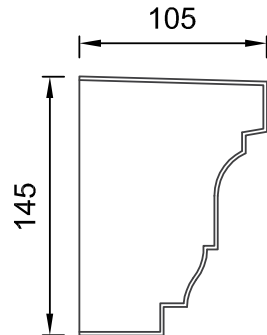

Art.Nr.:FSXBJA

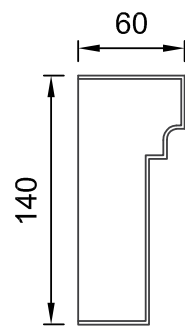

Art.Nr.:FSXBJE

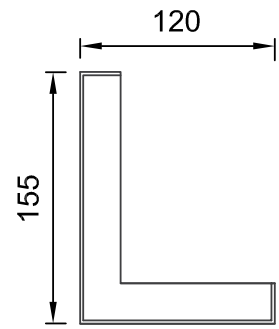

Art.Nr.:FSXBJI

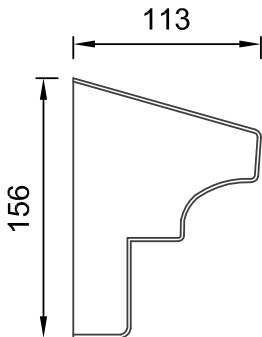

Art.Nr.:FSXBIX

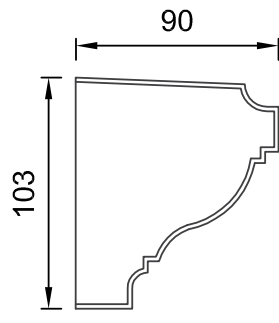

Art.Nr.:FSXBJB

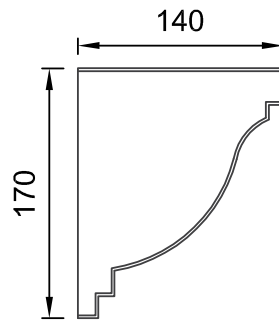

Art.Nr.:FSXBJF

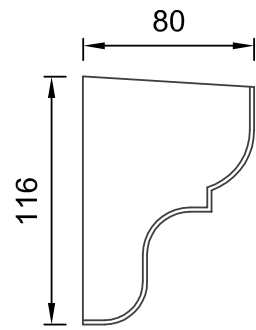

Art.Nr.:FSXBJJ

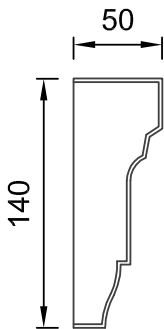

Art.Nr.:FSXBIV

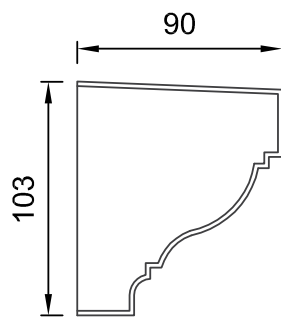

Art.Nr.:FSXBJC

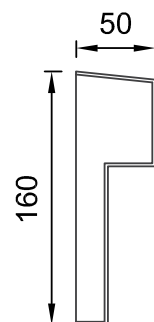

Art.Nr.:FSXBJG

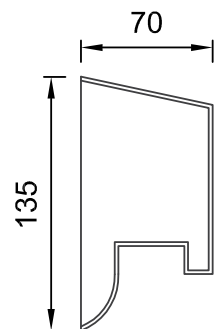

Art.Nr.:FSXBJK



QR-Code einfach scannen und
Austrotherm Materiallisten-Generator
online nutzen.

Austrotherm Sohlbankprofil

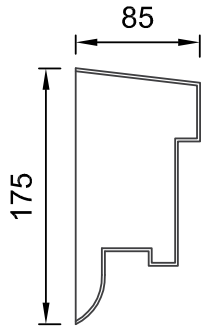

Art.Nr.:FSXBJL

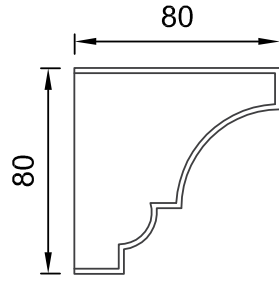

Art.Nr.:FSXBJQ

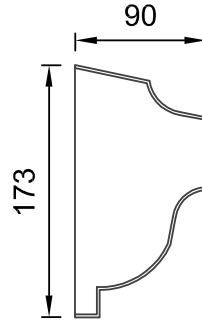

Art.Nr.:FSXBJU

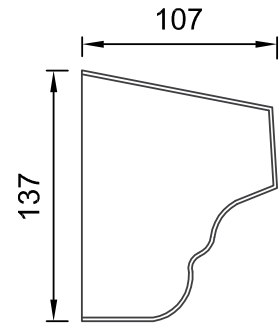

Art.Nr.:FSXBJY

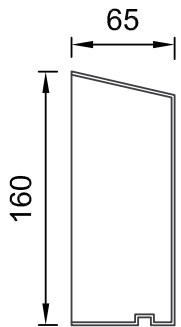

Art.Nr.:FSXBJM

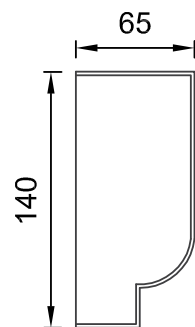

Art.Nr.:FSXBJR

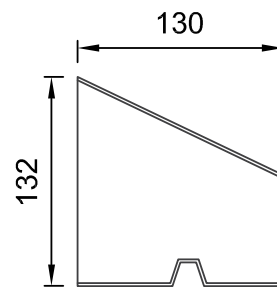

Art.Nr.:FSXBJV

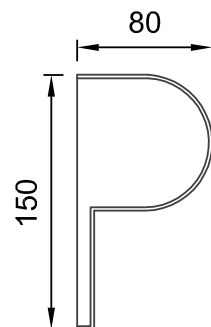

Art.Nr.:FSXBJZ

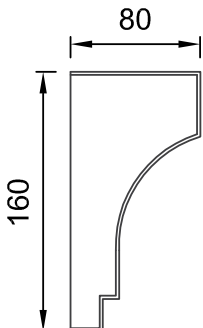

Art.Nr.:FSXBJN

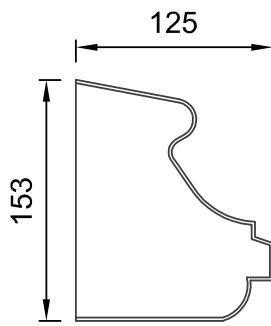

Art.Nr.:FSXBJS

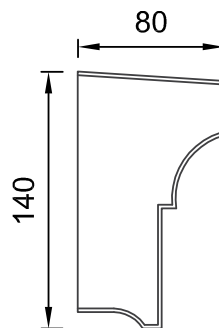

Art.Nr.:FSXBJW

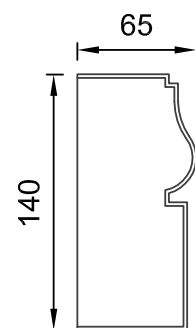

Art.Nr.:FSXBKA

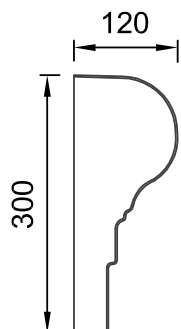

Art.Nr.:FSXBJP

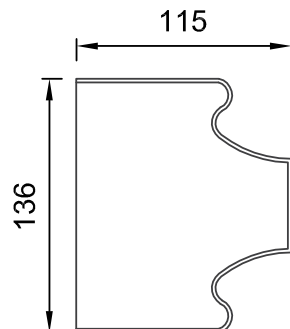

Art.Nr.:FSXBJT

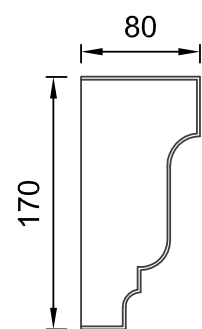

Art.Nr.:FSXBJX

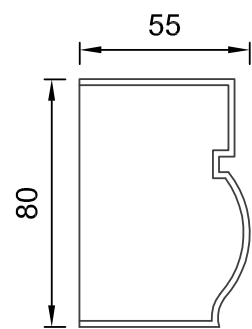

Art.Nr.:FSXBKB



QR-Code einfach scannen und
Austrotherm Materiallisten-Generator
online nutzen.

Austrotherm Sohlbankprofil

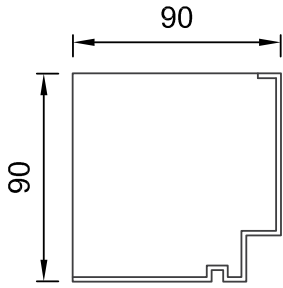

Art.Nr.:FSXBKC

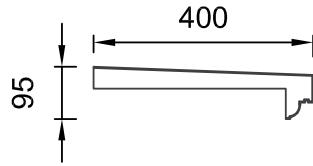

Art.Nr.:FSXBKG

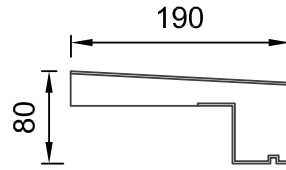

Art.Nr.:FSXBKK

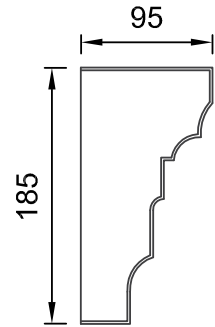

Art.Nr.:FSXBKO

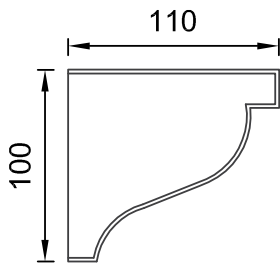

Art.Nr.:FSXBKD

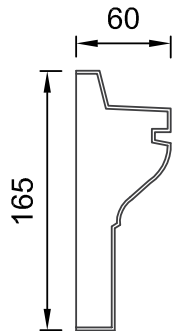

Art.Nr.:FSXBKH

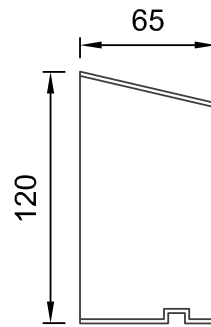

Art.Nr.:FSXBKL

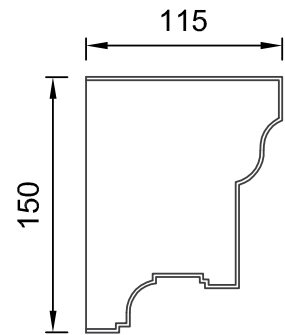

Art.Nr.:FSXBKP

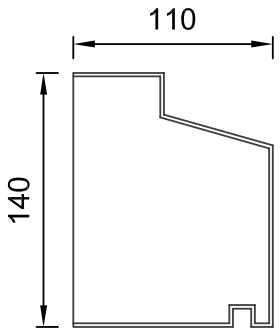

Art.Nr.:FSXBKE

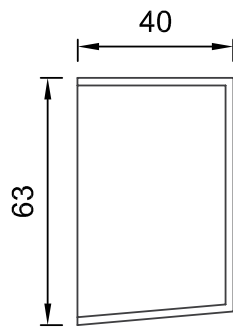

Art.Nr.:FSXBKI

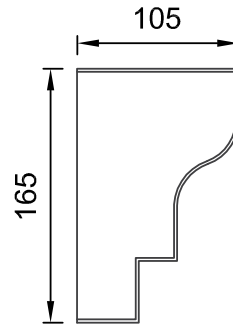

Art.Nr.:FSXBKM

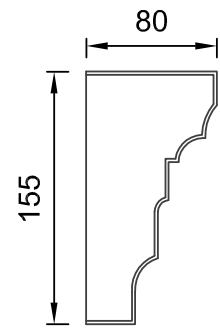

Art.Nr.:FSXBKQ

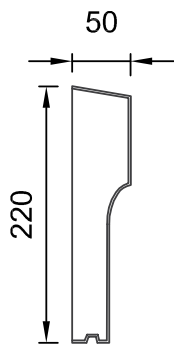

Art.Nr.:FSXBKF

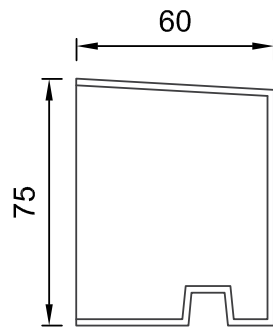

Art.Nr.:FSXBKJ

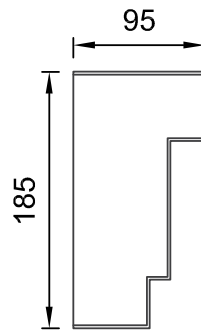

Art.Nr.:FSXBKN

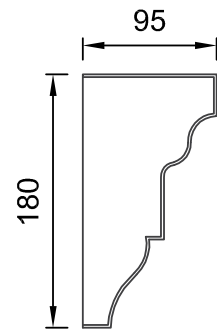

Art.Nr.:FSXBKR



QR-Code einfach scannen und
Austrotherm Materiallisten-Generator
online nutzen.

Austrotherm Sohlbankprofil

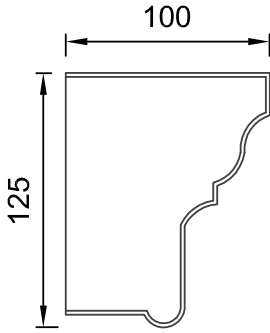

Art.Nr.:FSXBKS

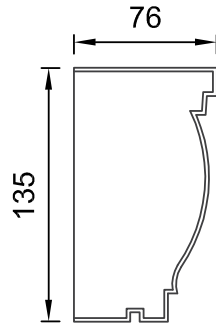

Art.Nr.:FSXBKW

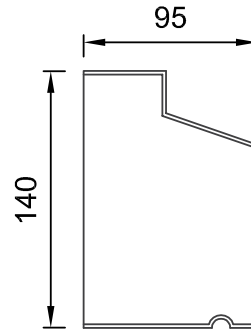

Art.Nr.:FSXBLA

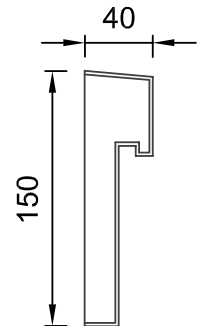

Art.Nr.:FSXBLE

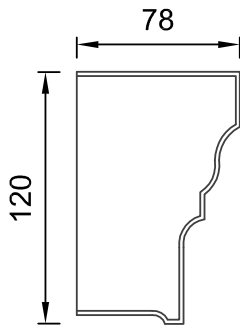

Art.Nr.:FSXBKT

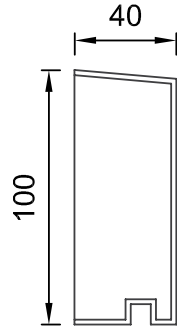

Art.Nr.:FSXBKX

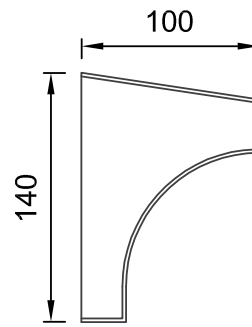

Art.Nr.:FSXBLB

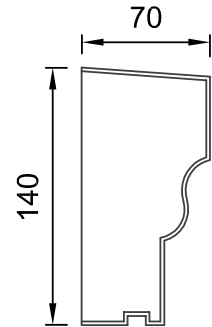

Art.Nr.:FSXBLF

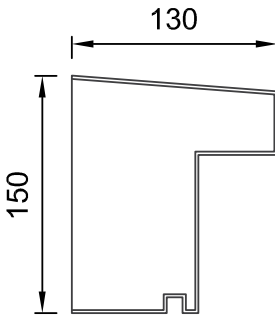

Art.Nr.:FSXBKU

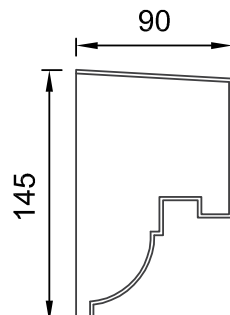

Art.Nr.:FSXBKY

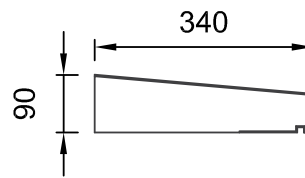

Art.Nr.:FSXBLC

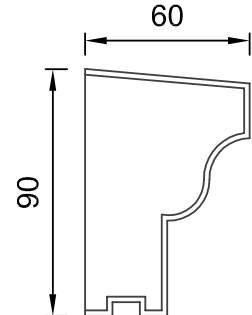

Art.Nr.:FSXBLG

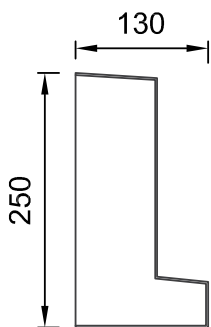

Art.Nr.:FSXBKV

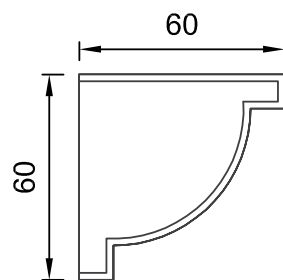

Art.Nr.:FSXBKZ

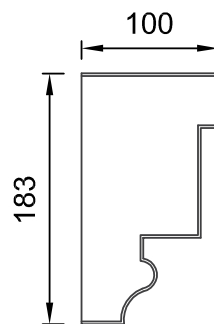

Art.Nr.:FSXBLD

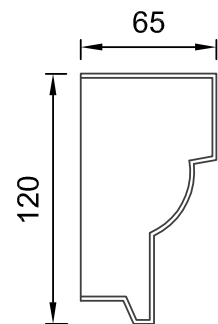

Art.Nr.:FSXBLH



QR-Code einfach scannen und
Austrotherm Materiallisten-Generator
online nutzen.

Austrotherm Sohlbankprofil

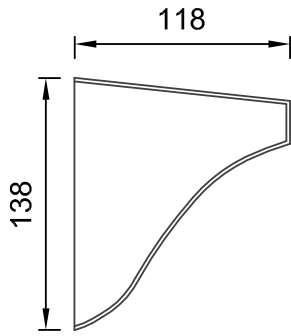

Art.Nr.:FSXBLL

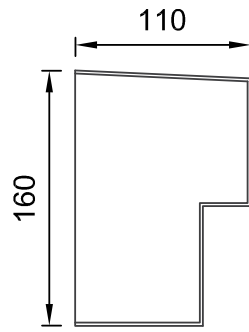

Art.Nr.:FSXBLM

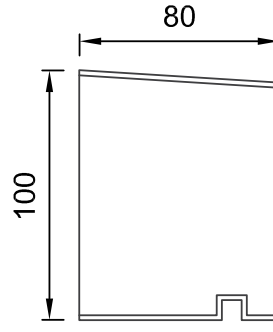

Art.Nr.:FSXBLQ

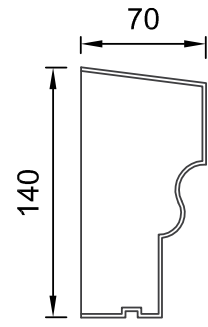

Art.Nr.:FSXBLU

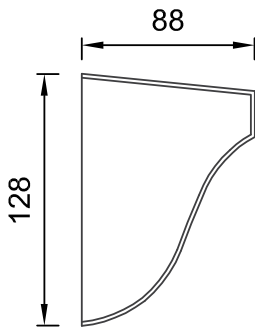

Art.Nr.:FSXBLLJ

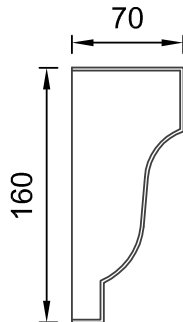

Art.Nr.:FSXBLN

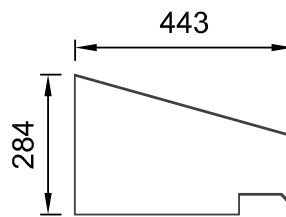

Art.Nr.:FSXBLR

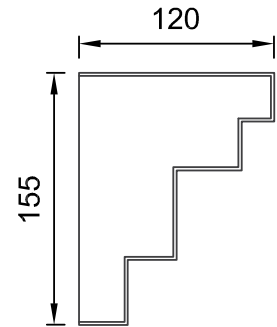

Art.Nr.:FSXBLV

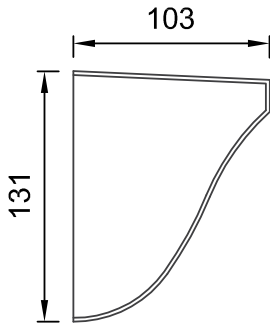

Art.Nr.:FSXBLLK

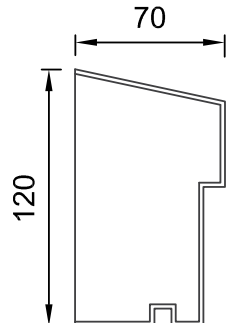

Art.Nr.:FSXBLO

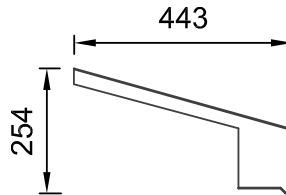

Art.Nr.:FSXBLS

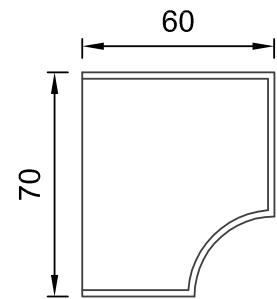

Art.Nr.:FSXBLLW

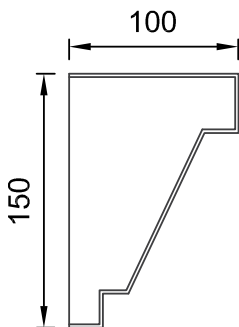

Art.Nr.:FSXBLLL

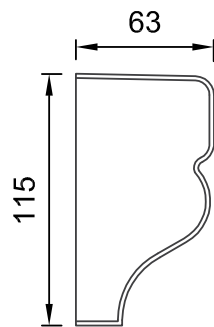

Art.Nr.:FSXBLLP

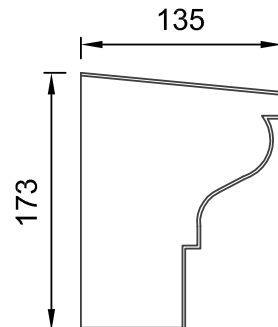

Art.Nr.:FSXBLLT

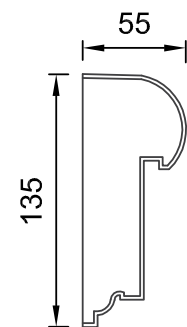

Art.Nr.:FSXBLLX



QR-Code einfach scannen und
Austrotherm Materiallisten-Generator
online nutzen.

Austrotherm Sohlbankprofil

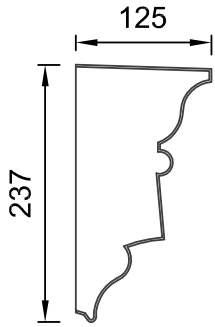

Art.Nr.:FSXBLY

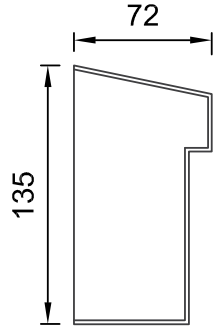

Art.Nr.:FSXBMC

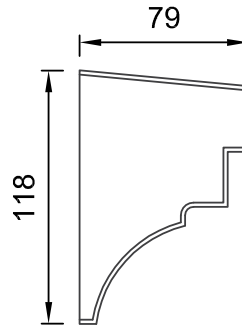

Art.Nr.:FSXBMG

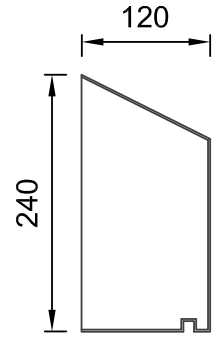

Art.Nr.:FSXBMK

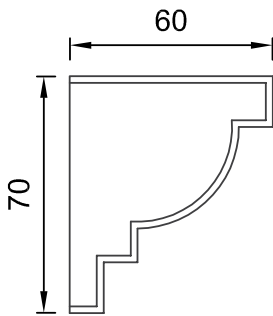

Art.Nr.:FSXBLZ

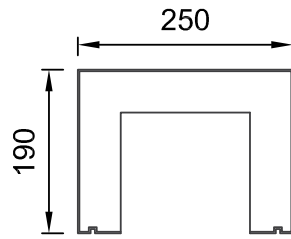

Art.Nr.:FSXBMD

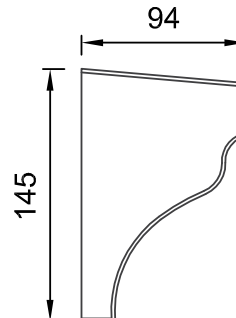

Art.Nr.:FSXBMH

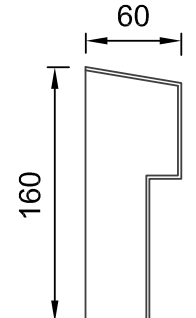

Art.Nr.:FSXBML

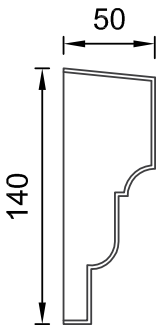

Art.Nr.:FSXBMA

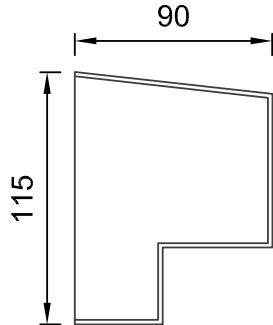

Art.Nr.:FSXBME

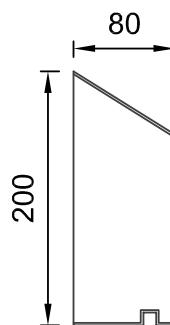

Art.Nr.:FSXBMI

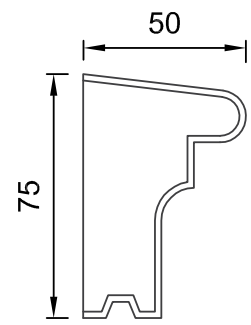

Art.Nr.:FSXBMM

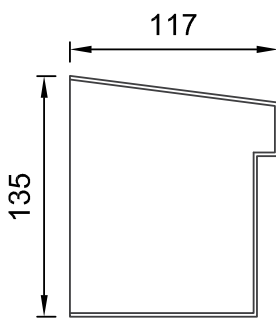

Art.Nr.:FSXBMB

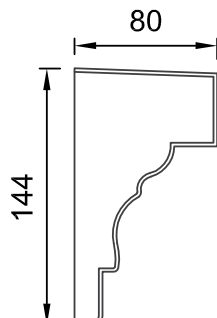

Art.Nr.:FSXBMF

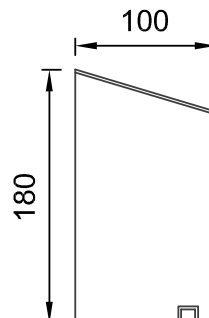

Art.Nr.:FSXBMJ

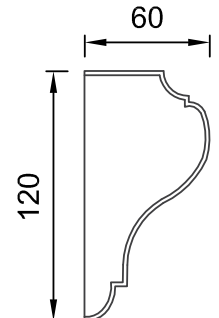

Art.Nr.:FSXBMN



QR-Code einfach scannen und
Austrotherm Materiallisten-Generator
online nutzen.

Austrotherm Sohlbankprofil

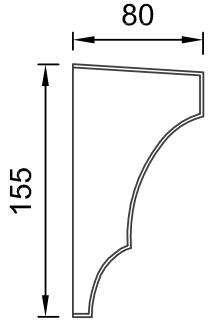

Art.Nr.:FSXBMO

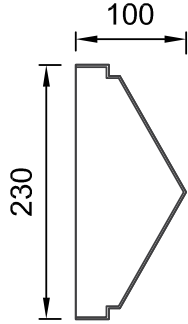

Art.Nr.:FSXBMS

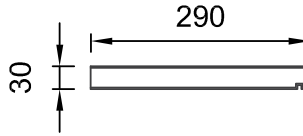

Art.Nr.:FSXBMX

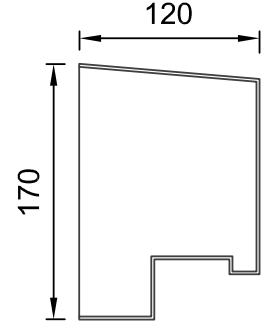

Art.Nr.:FSXBNB

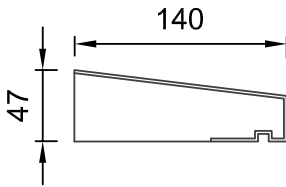

Art.Nr.:FSXBMP

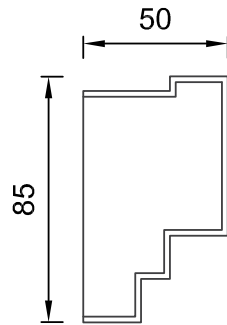

Art.Nr.:FSXBMT

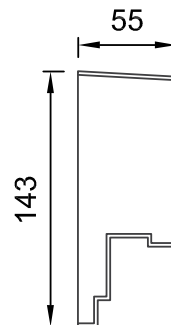

Art.Nr.:FSXBMY

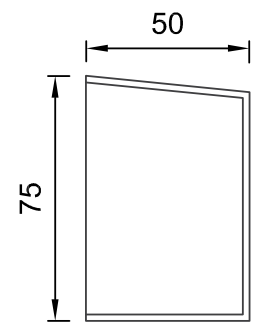

Art.Nr.:FSXBNC

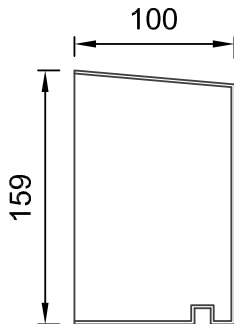

Art.Nr.:FSXBMQ

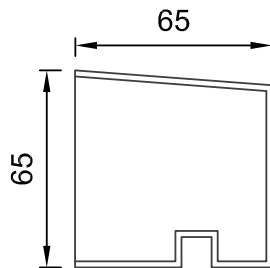

Art.Nr.:FSXBMU

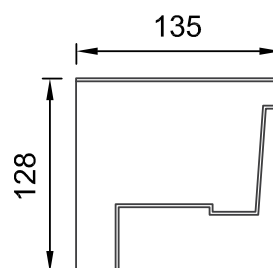

Art.Nr.:FSXBMZ

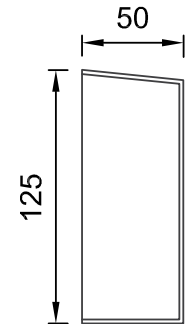

Art.Nr.:FSXBND

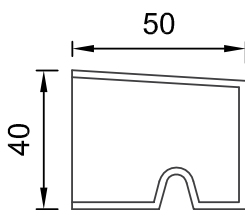

Art.Nr.:FSXBMR

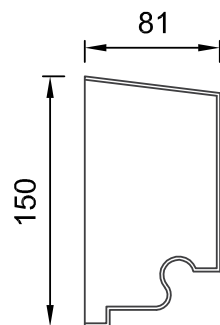

Art.Nr.:FSXBMW

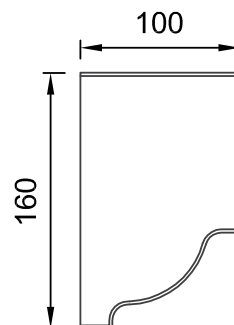

Art.Nr.:FSXBNA

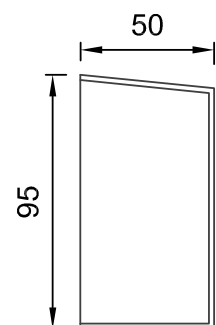

Art.Nr.:FSXBNE



QR-Code einfach scannen und
Austrotherm Materiallisten-Generator
online nutzen.

Austrotherm Sohlbankprofil

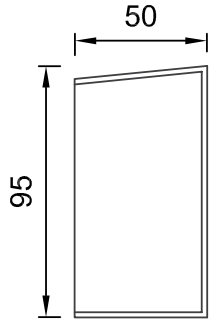

Art.Nr.:FSXBNF

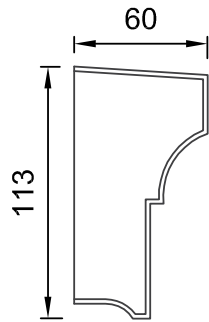

Art.Nr.:FSXBNL

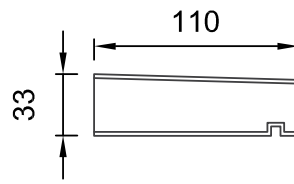

Art.Nr.:FSXBNT

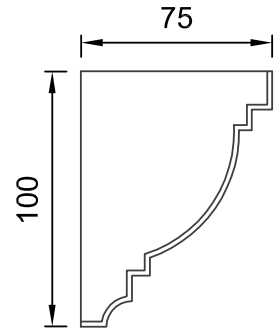

Art.Nr.:FSXBNX

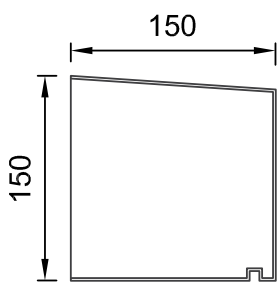

Art.Nr.:FSXBNG

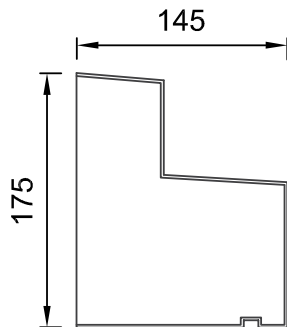

Art.Nr.:FSXBNM

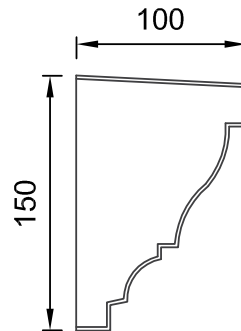

Art.Nr.:FSXBNU

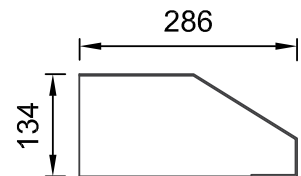

Art.Nr.:FSXBNY

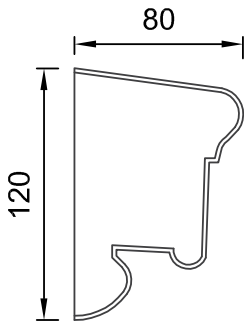

Art.Nr.:FSXBNH

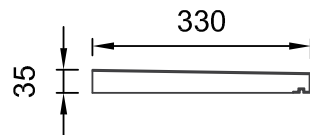

Art.Nr.:FSXBNN

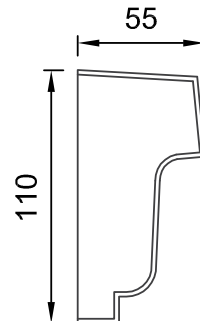

Art.Nr.:FSXBNV

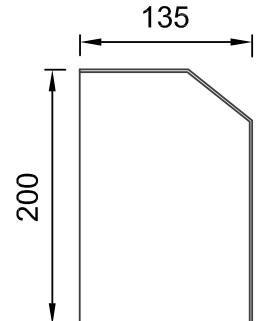

Art.Nr.:FSXBNZ

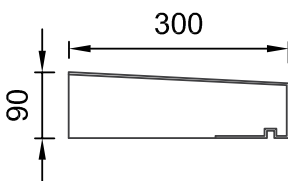

Art.Nr.:FSXBNI

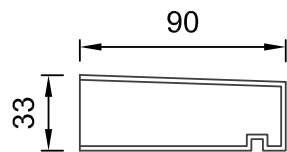

Art.Nr.:FSXBNS

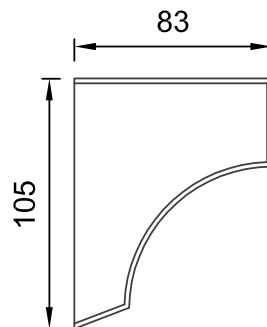

Art.Nr.:FSXBNW

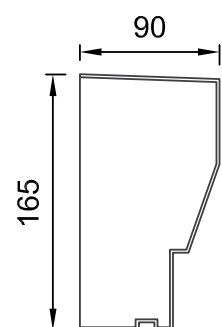

Art.Nr.:FSXBOA



QR-Code einfach scannen und
Austrotherm Materiallisten-Generator
online nutzen.

Austrotherm Sohlbankprofil

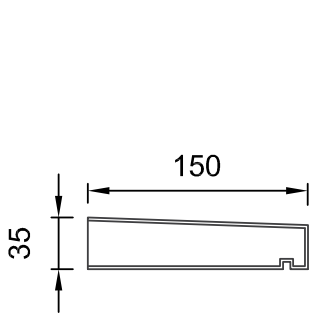

Art.Nr.:FSXBOD

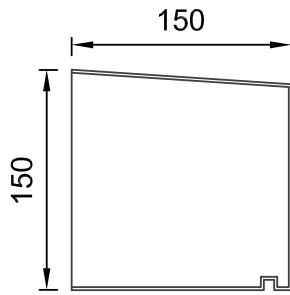

Art.Nr.:FSXBOG

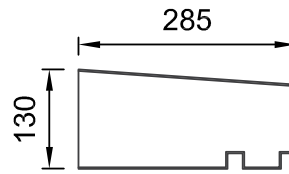

Art.Nr.:FSXBOK

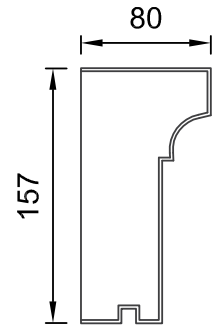

Art.Nr.:FSXBOO

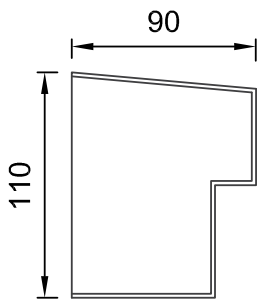

Art.Nr.:FSXBOD

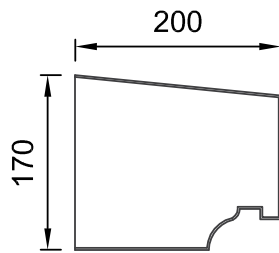

Art.Nr.:FSXBOH

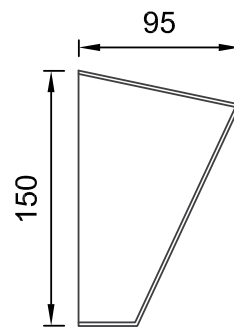

Art.Nr.:FSXBOL

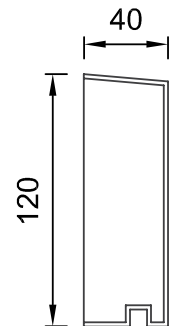

Art.Nr.:FSXBOP

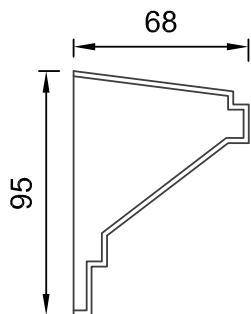

Art.Nr.:FSXBOE

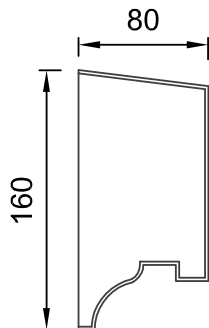

Art.Nr.:FSXBOI

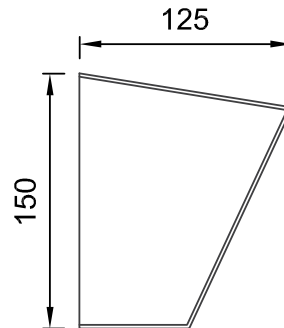

Art.Nr.:FSXBOM

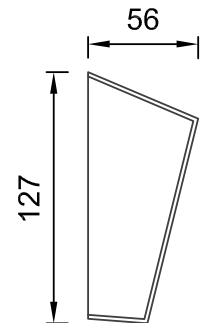

Art.Nr.:FSXBOQ

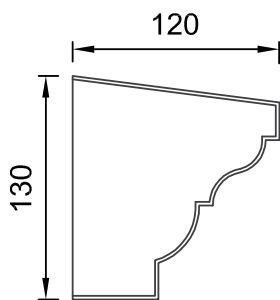

Art.Nr.:FSXBOD

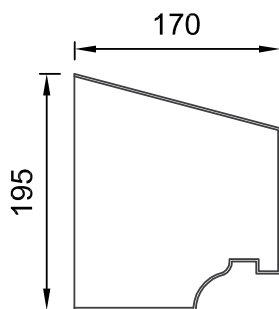

Art.Nr.:FSXBOJ

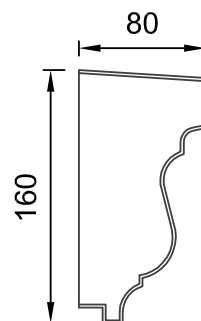

Art.Nr.:FSXBON

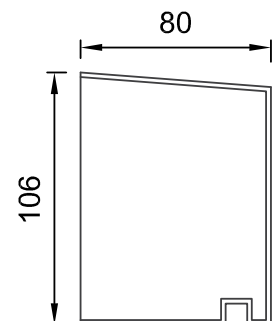

Art.Nr.:FSXBOR



QR-Code einfach scannen und
Austrotherm Materiallisten-Generator
online nutzen.

Austrotherm Sohlbankprofil

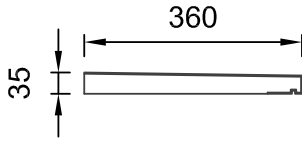

Art.Nr.:FSXBOV

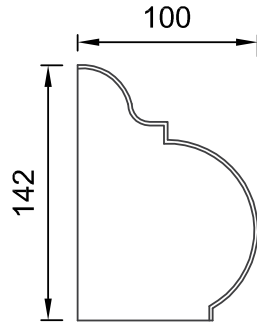

Art.Nr.:FSXBOZ

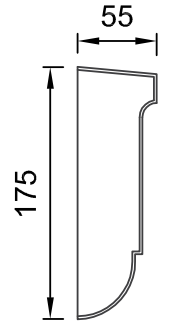

Art.Nr.:FSXCWH

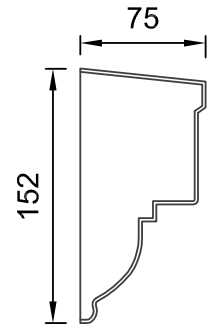

Art.Nr.:FSXCWL

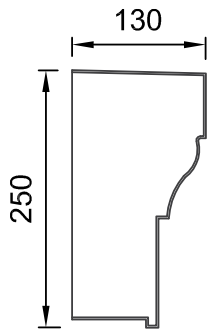

Art.Nr.:FSXBOW

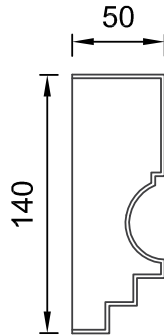

Art.Nr.:FSXBPA

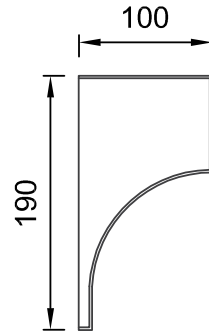

Art.Nr.:FSXCWI

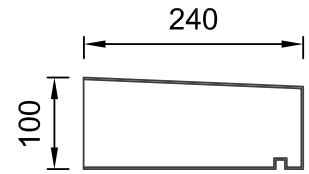

Art.Nr.:FSXCWM

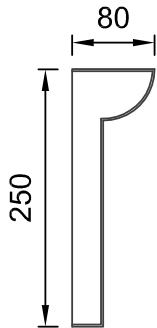

Art.Nr.:FSXBOX

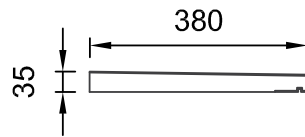

Art.Nr.:FSXBPC

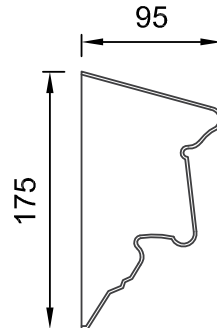

Art.Nr.:FSXCWJ

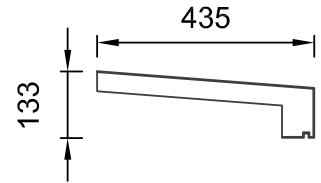

Art.Nr.:FSXCWQ

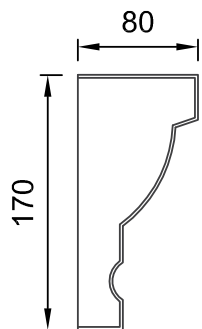

Art.Nr.:FSXBOY

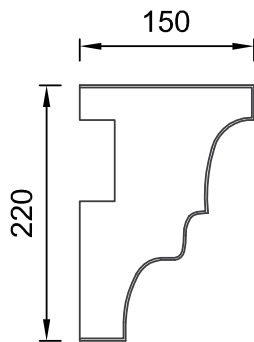

Art.Nr.:FSXCWG

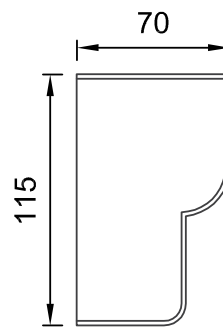

Art.Nr.:FSXCWK

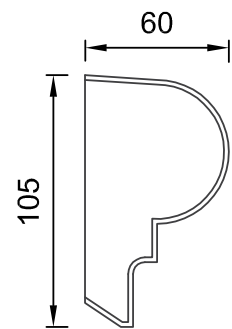

Art.Nr.:FSXCWX



QR-Code einfach scannen und
Austrotherm Materiallisten-Generator
online nutzen.

Austrotherm Sohlbankprofil

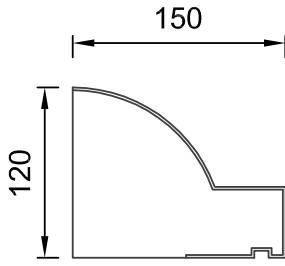

Art.Nr.:FSXCWY

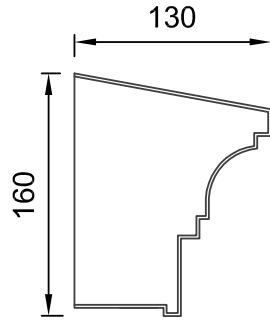

Art.Nr.:FSXCXC

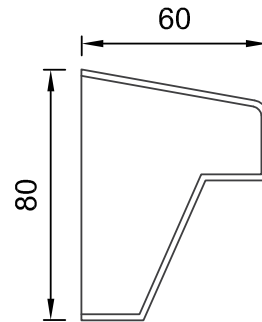

Art.Nr.:FSXCXG

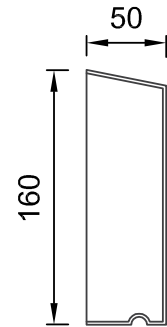

Art.Nr.:FSXCXL

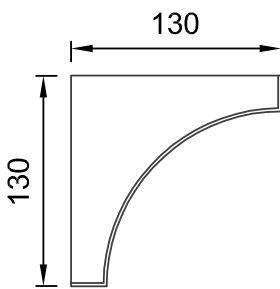

Art.Nr.:FSXCWZ

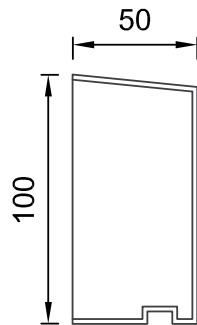

Art.Nr.:FSXCXD

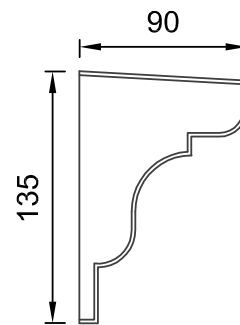

Art.Nr.:FSXCXH

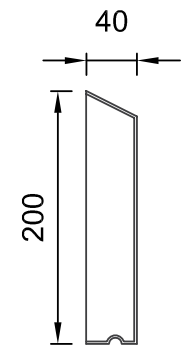

Art.Nr.:FSXCXM

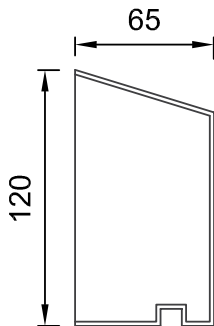

Art.Nr.:FSXCXA

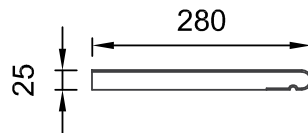

Art.Nr.:FSXCXE

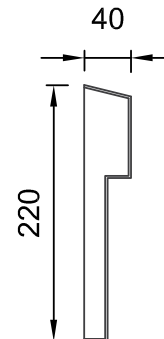

Art.Nr.:FSXCXJ

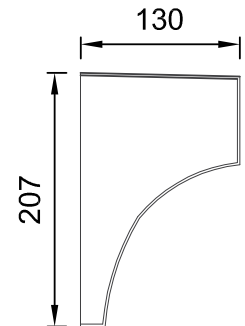

Art.Nr.:FSXCXN

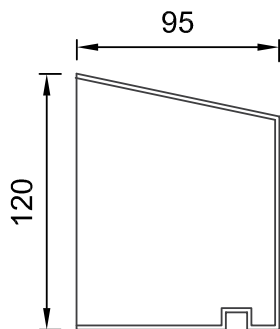

Art.Nr.:FSXCXB

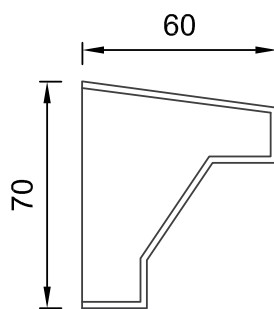

Art.Nr.:FSXCXF

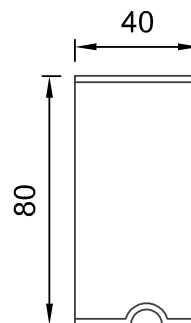

Art.Nr.:FSXCXK

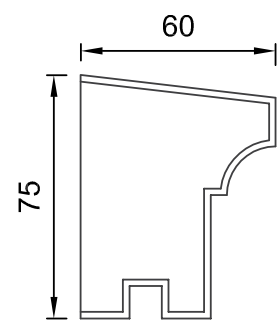

Art.Nr.:FSXCXO



QR-Code einfach scannen und
Austrotherm Materiallisten-Generator
online nutzen.

Austrotherm Sohlbankprofil

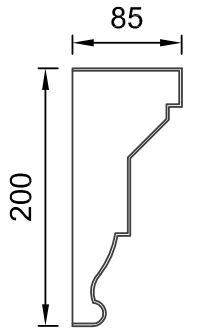

Art.Nr.:FSXCXP

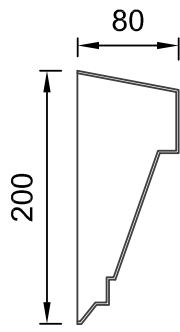

Art.Nr.:FSXCXU

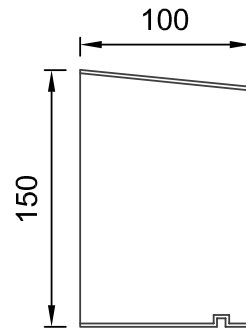

Art.Nr.:FSXCXY

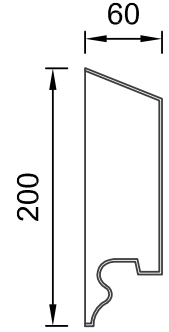

Art.Nr.:FSXCYC

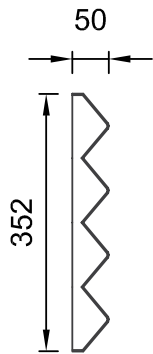

Art.Nr.:FSXCXQ

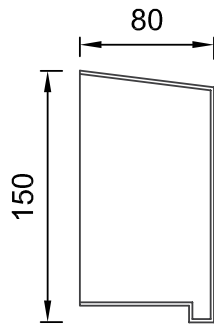

Art.Nr.:FSXCXV

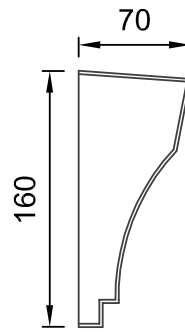

Art.Nr.:FSXCXZ

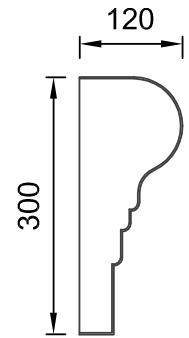

Art.Nr.:FSXCXD

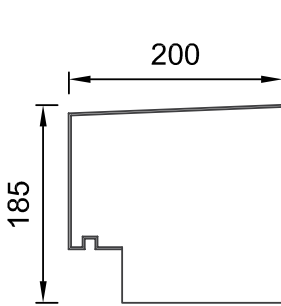

Art.Nr.:FSXCXS

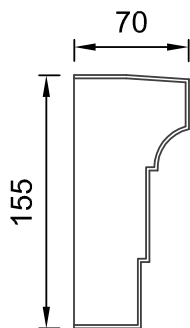

Art.Nr.:FSXCXW

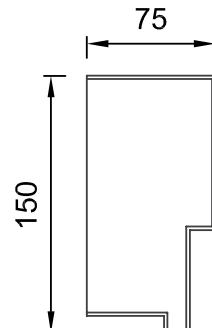

Art.Nr.:FSXCYA

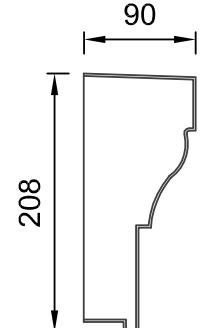

Art.Nr.:FSXCYE

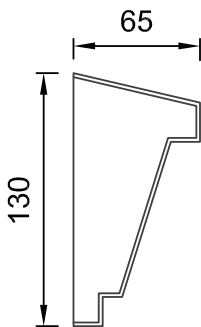

Art.Nr.:FSXCXT

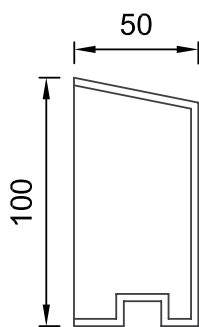

Art.Nr.:FSXCXX

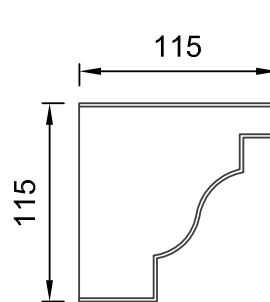

Art.Nr.:FSXCYB

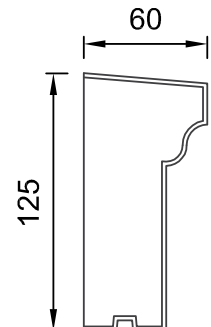

Art.Nr.:FSXCYF



QR-Code einfach scannen und
Austrotherm Materialisten-Generator
online nutzen.

Austrotherm Sohlbankprofil

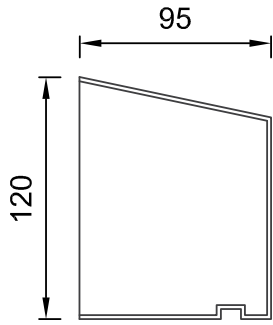

Art.Nr.:FSXCYG

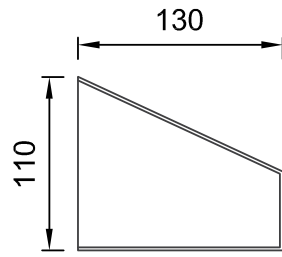

Art.Nr.:FSXCYL

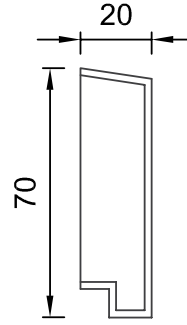

Art.Nr.:FSXCYQ

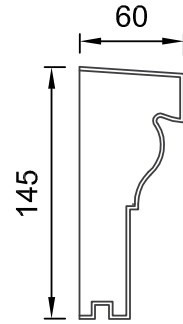

Art.Nr.:FSXCYX

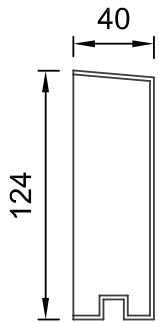

Art.Nr.:FSXCYH

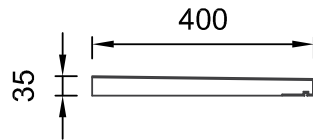

Art.Nr.:FSXCYN

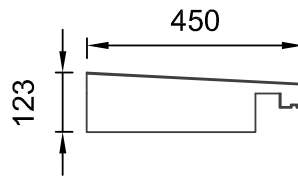

Art.Nr.:FSXCYR

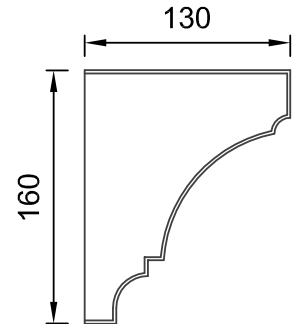

Art.Nr.:FSXCYZ

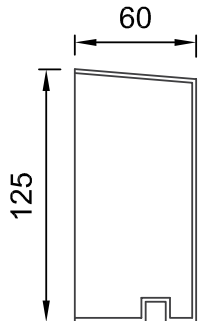

Art.Nr.:FSXCYI

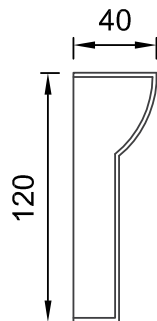

Art.Nr.:FSXCYO

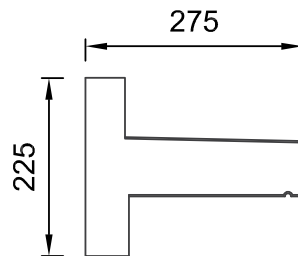

Art.Nr.:FSXCYT

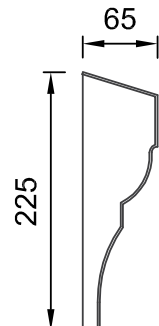

Art.Nr.:FSXCYZ

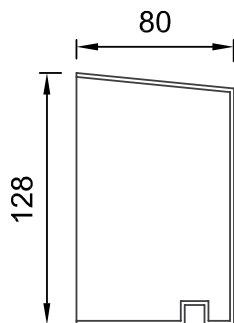

Art.Nr.:FSXCYJ

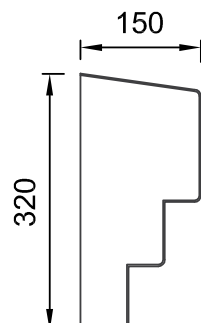

Art.Nr.:FSXCYP

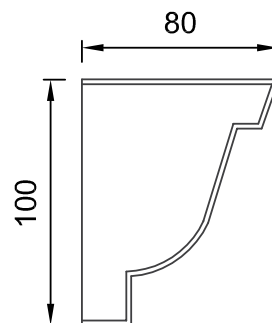

Art.Nr.:FSXCYW

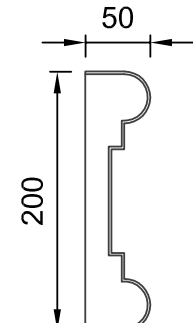

Art.Nr.:FSXCZA



QR-Code einfach scannen und
Austrotherm Materiallisten-Generator
online nutzen.

Austrotherm Sohlbankprofil

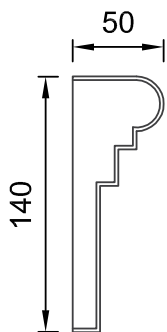

Art.Nr.:FSXCZB

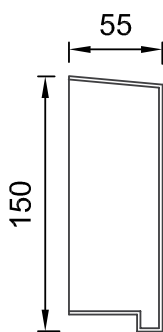

Art.Nr.:FSXCZF

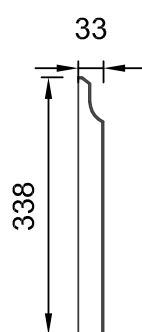

Art.Nr.:FSXCZJ

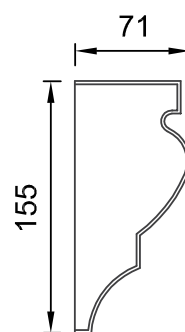

Art.Nr.:FSXCZO

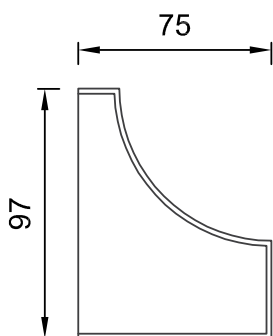

Art.Nr.:FSXCZC

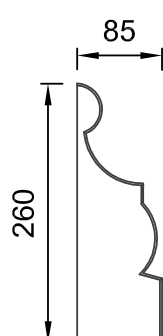

Art.Nr.:FSXCZG

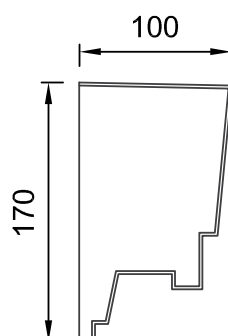

Art.Nr.:FSXCZK

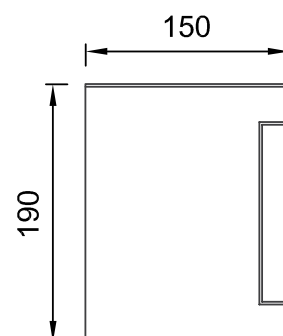

Art.Nr.:FSXCZP

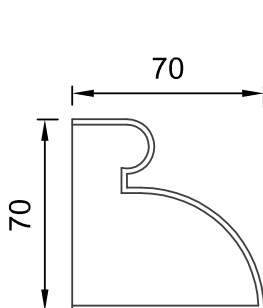

Art.Nr.:FSXCZD

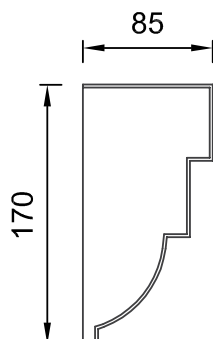

Art.Nr.:FSXCZH

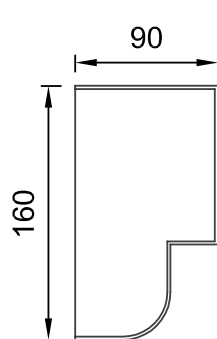

Art.Nr.:FSXCZL

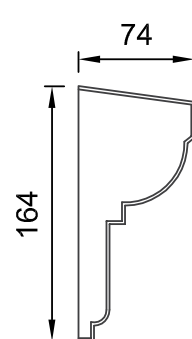

Art.Nr.:FSXCZQ

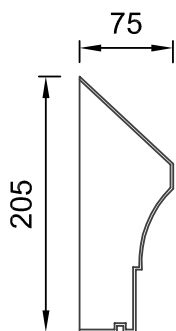

Art.Nr.:FSXCZE

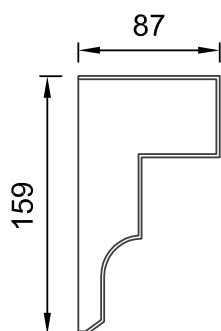

Art.Nr.:FSXCZI

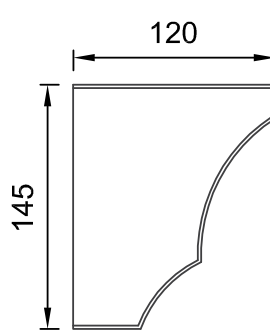

Art.Nr.:FSXCZM

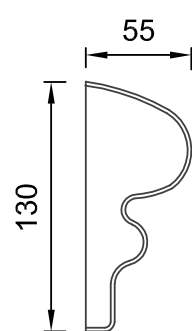

Art.Nr.:FSXCZR



QR-Code einfach scannen und
Austrotherm Materialisten-Generator
online nutzen.

Austrotherm Sohlbankprofil

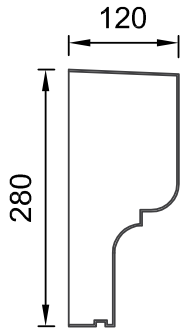

Art.Nr.:FSXCZS

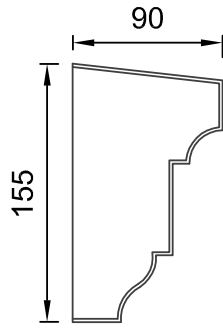

Art.Nr.:FSXCZX

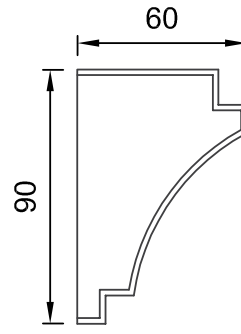

Art.Nr.:FSXDAC

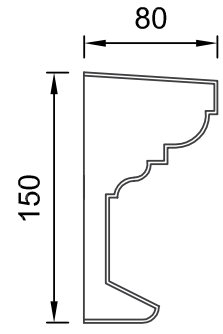

Art.Nr.:FSXDAG

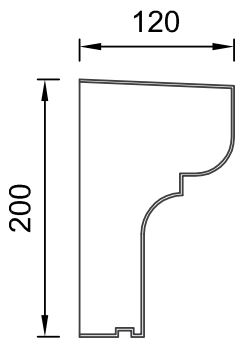

Art.Nr.:FSXCZT

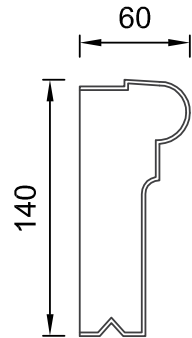

Art.Nr.:FSXCZY

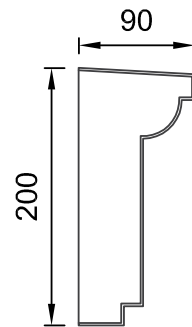

Art.Nr.:FSXDAD

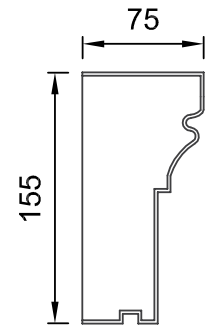

Art.Nr.:FSXDAH

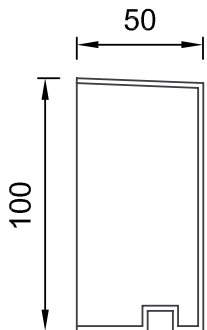

Art.Nr.:FSXCZV

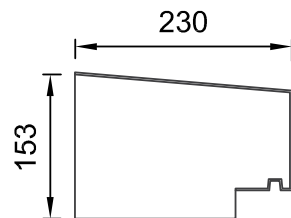

Art.Nr.:FSXCZZ

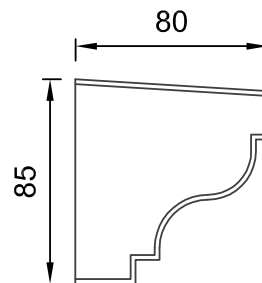

Art.Nr.:FSXDAE

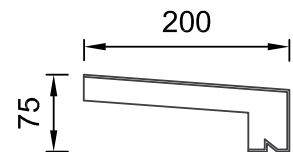

Art.Nr.:FSXDAI

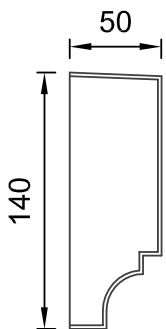

Art.Nr.:FSXCZW

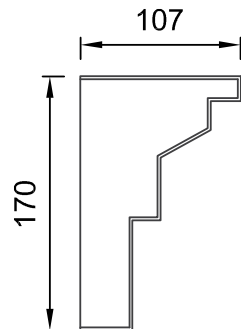

Art.Nr.:FSXDAB

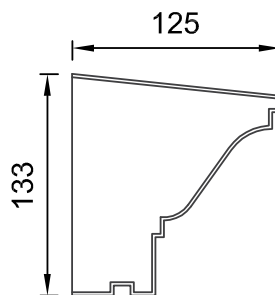

Art.Nr.:FSXDAB

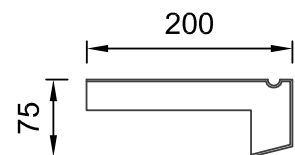

Art.Nr.:FSXDAK



QR-Code einfach scannen und
Austrotherm Materiallisten-Generator
online nutzen.

Austrotherm Sohlbankprofil

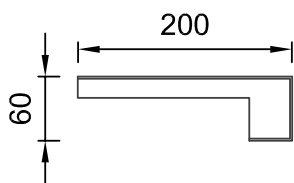

Art.Nr.:FSXDAM

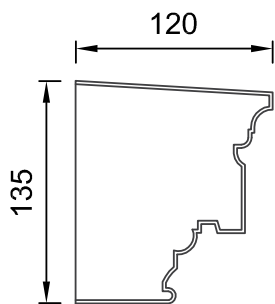

Art.Nr.:FSXDAR

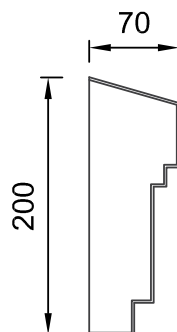

Art.Nr.:FSXDAW

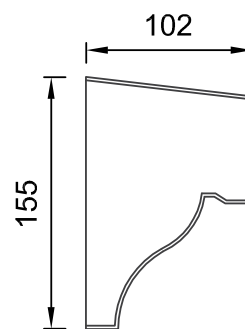

Art.Nr.:FSXDBA

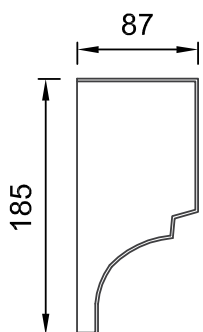

Art.Nr.:FSXDAA

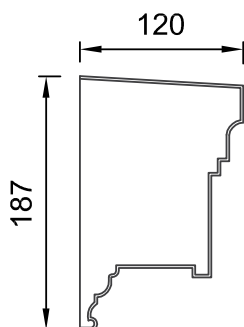

Art.Nr.:FSXDAS

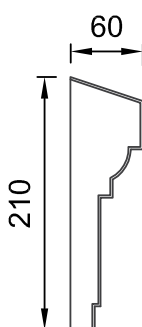

Art.Nr.:FSXDAX

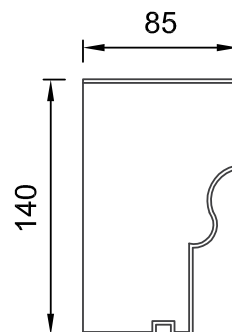

Art.Nr.:FSXDAB

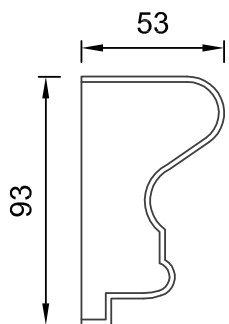

Art.Nr.:FSXDAP

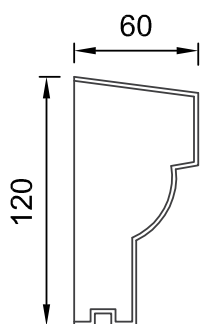

Art.Nr.:FSXDAU

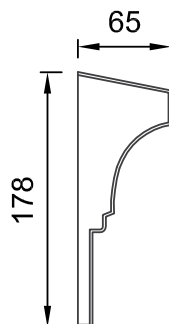

Art.Nr.:FSXDAY

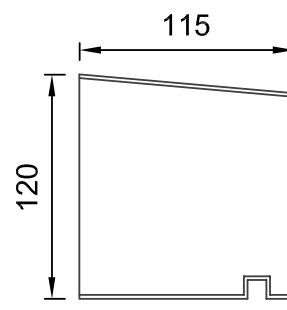

Art.Nr.:FSXDAB

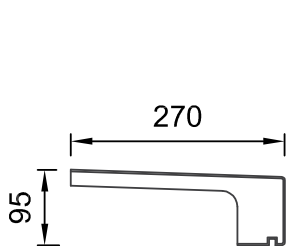

Art.Nr.:FSXDAA

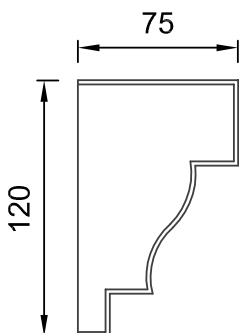

Art.Nr.:FSXDAV

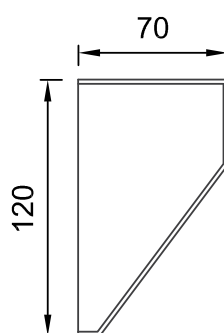

Art.Nr.:FSXDAZ

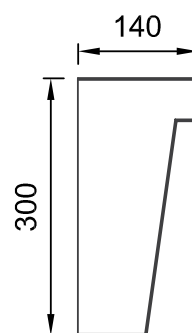

Art.Nr.:FSXDAB



QR-Code einfach scannen und
Austrotherm Materiallisten-Generator
online nutzen.

Austrotherm Sohlbankprofil

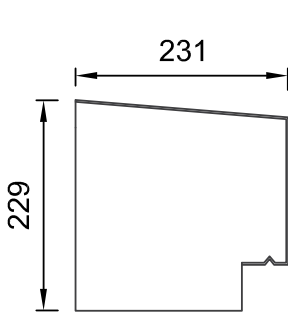

Art.Nr.:FSXDBE

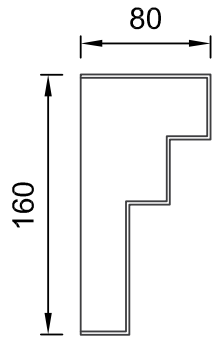

Art.Nr.:FSXDBK

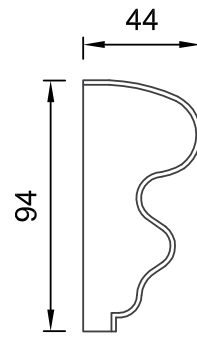

Art.Nr.:FSXDBO

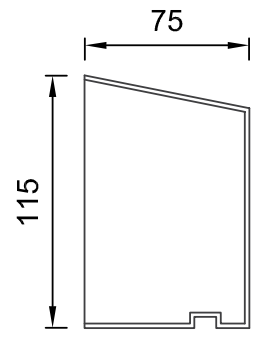

Art.Nr.:FSXDBT

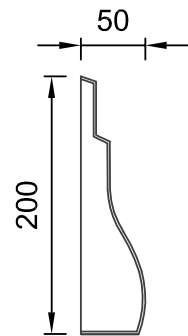

Art.Nr.:FSXDBH

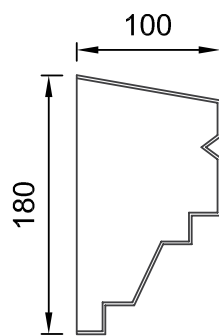

Art.Nr.:FSXDBL

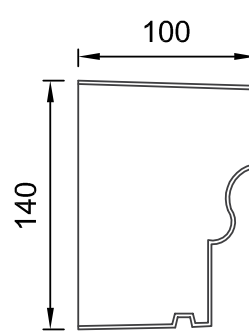

Art.Nr.:FSXDBP

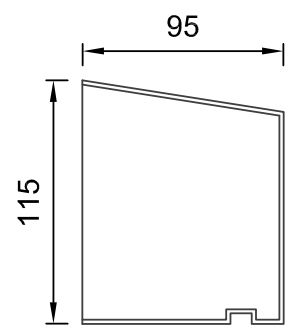

Art.Nr.:FSXDBU

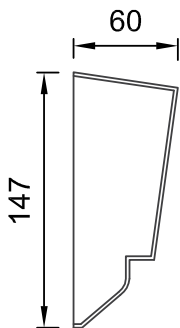

Art.Nr.:FSXDBI

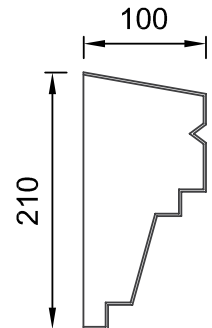

Art.Nr.:FSXDBM

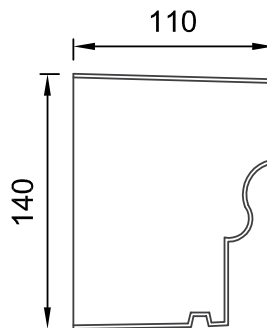

Art.Nr.:FSXDBQ

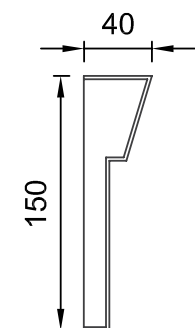

Art.Nr.:FSXDBV

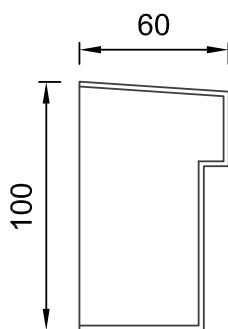

Art.Nr.:FSXDBJ

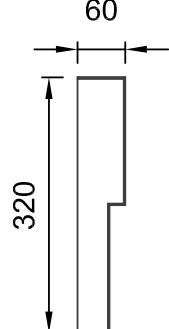

Art.Nr.:FSXDBN

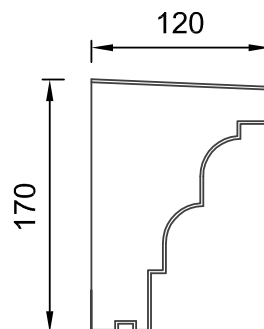

Art.Nr.:FSXDBS

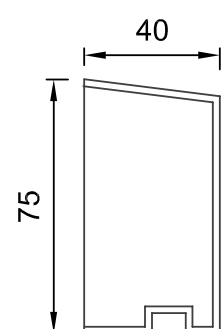

Art.Nr.:FSXDBW



QR-Code einfach scannen und
Austrotherm Materiallisten-Generator
online nutzen.

Austrotherm Sohlbankprofil

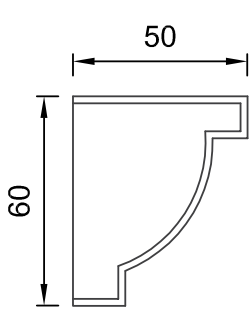

Art.Nr.:FSXDBX

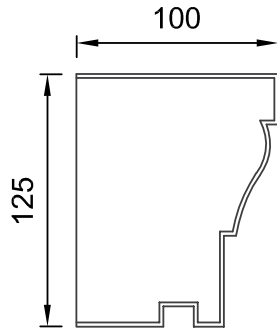

Art.Nr.:FSXDCC

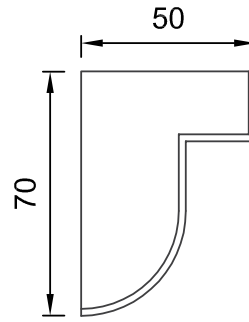

Art.Nr.:FSXDCl

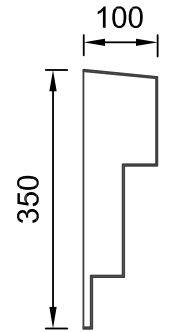

Art.Nr.:FSXDcM

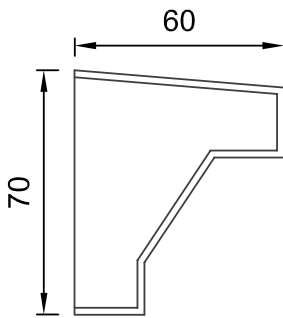

Art.Nr.:FSXDBy

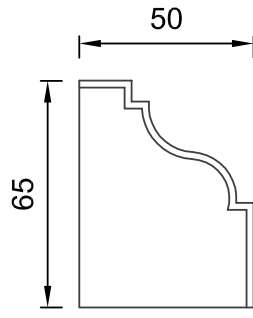

Art.Nr.:FSXDcD

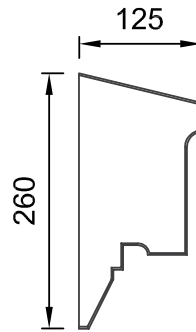

Art.Nr.:FSXDcJ

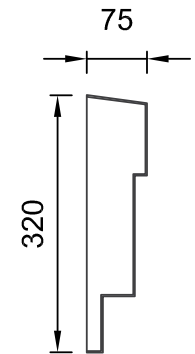

Art.Nr.:FSXDcN

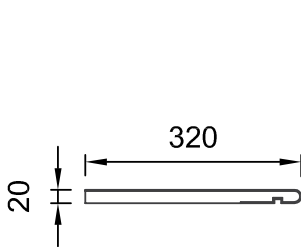

Art.Nr.:FSXDcZ

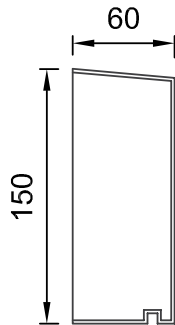

Art.Nr.:FSXDcG

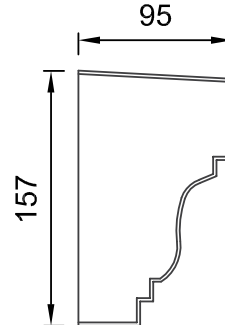

Art.Nr.:FSXDcK

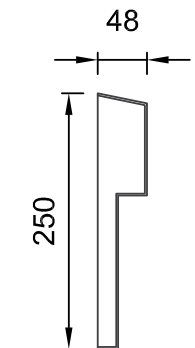

Art.Nr.:FSXDcO

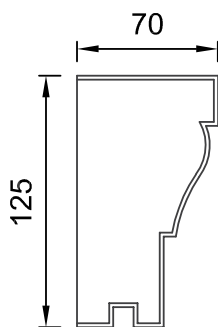

Art.Nr.:FSXDcB

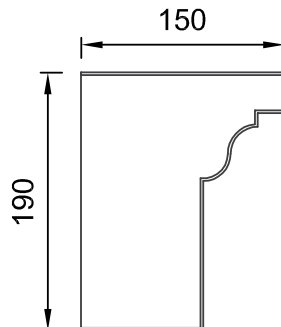

Art.Nr.:FSXDcH

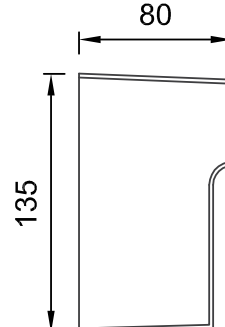

Art.Nr.:FSXDcL

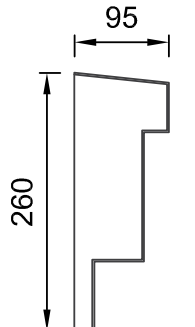

Art.Nr.:FSXDcP



QR-Code einfach scannen und
Austrotherm Materiallisten-Generator
online nutzen.

Austrotherm Sohlbankprofil

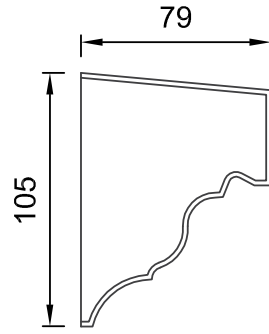

Art.Nr.:FSXDCQ

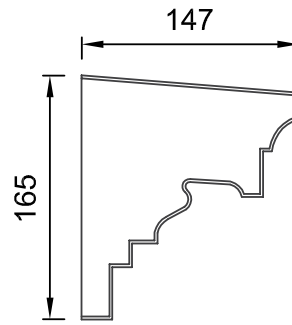

Art.Nr.:FSXDCU

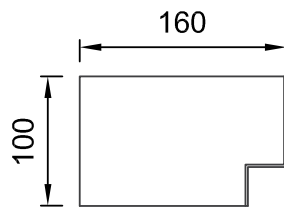

Art.Nr.:FSXDCR

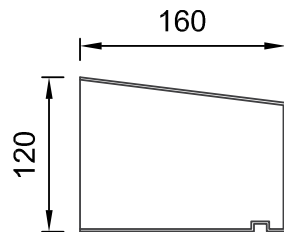

Art.Nr.:FSXDSC

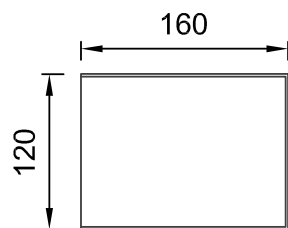

Art.Nr.:FSXDCT



QR-Code einfach scannen und
Austrotherm Materialisten-Generator
online nutzen.

Austrotherm Rahmenprofil

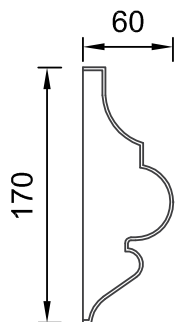

Art.Nr.: FFXAAC

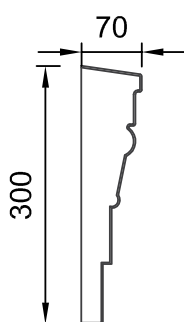

Art.Nr.: FFXAAG

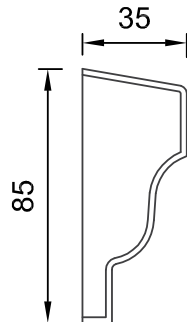

Art.Nr.: FFXAAM

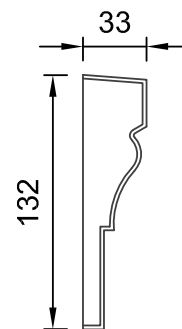

Art.Nr.: FFXAAR

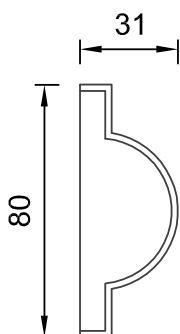

Art.Nr.: FFXAAD

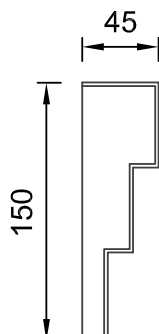

Art.Nr.: FFXAAH

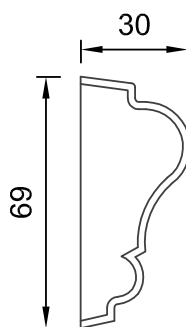

Art.Nr.: FFXAAN

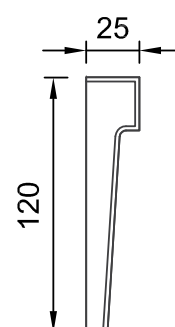

Art.Nr.: FFXAAS

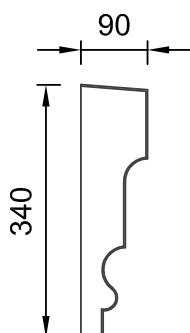

Art.Nr.: FFXAAE

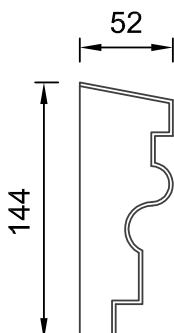

Art.Nr.: FFXAAI

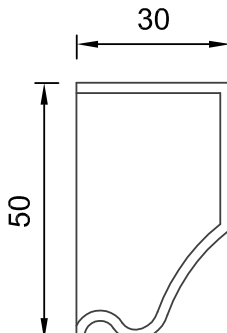

Art.Nr.: FFXAAO

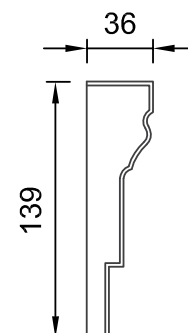

Art.Nr.: FFXAAT

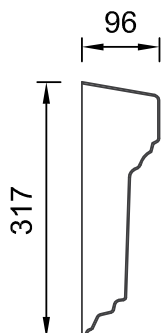

Art.Nr.: FFXAAF

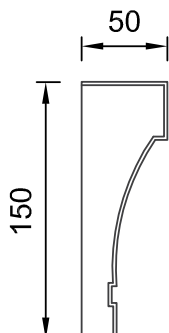

Art.Nr.: FFXAAK

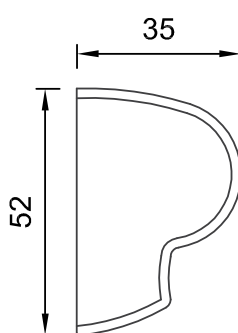

Art.Nr.: FFXAAP

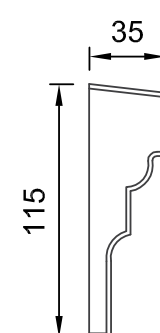

Art.Nr.: FFXAAU



QR-Code einfach scannen und
Austrotherm Materiallisten-Generator
online nutzen.

Austrotherm Rahmenprofil

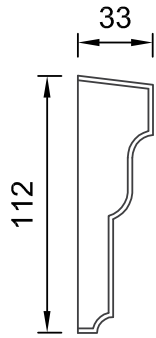

Art.Nr.: FFXAAV

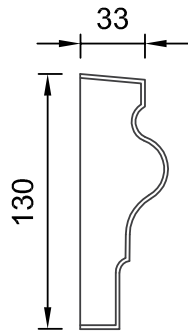

Art.Nr.: FFXABA

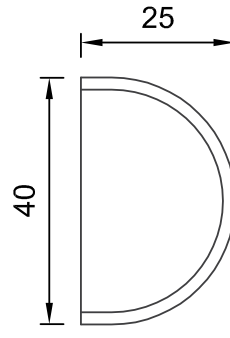

Art.Nr.: FFXABE

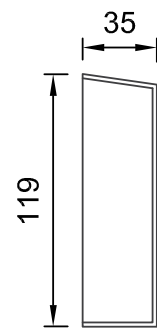

Art.Nr.: FFXABI

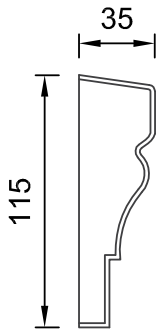

Art.Nr.: FFXAAX

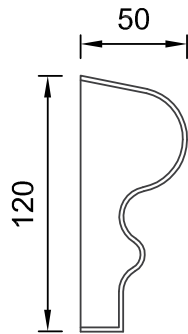

Art.Nr.: FFXABB

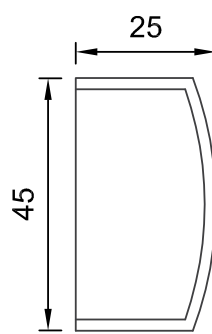

Art.Nr.: FFXABF

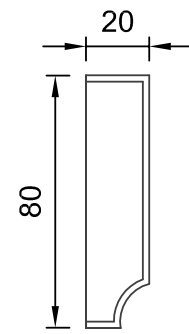

Art.Nr.: FFXABK

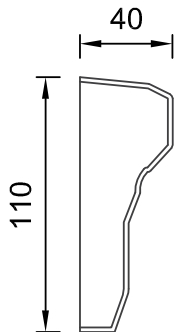

Art.Nr.: FFXAAY

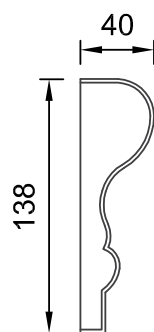

Art.Nr.: FFXABC

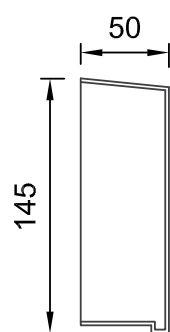

Art.Nr.: FFXABG

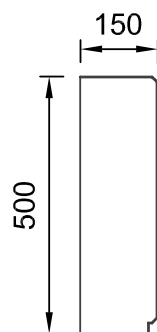

Art.Nr.: FFXABL

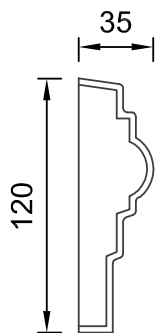

Art.Nr.: FFXAAZ

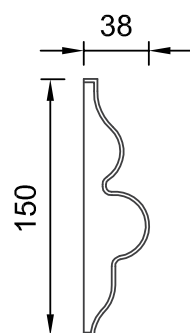

Art.Nr.: FFXABD

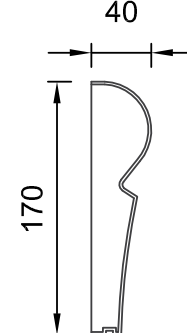

Art.Nr.: FFXABH

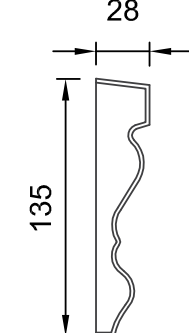

Art.Nr.: FFXABM



QR-Code einfach scannen und
Austrotherm Materialisten-Generator
online nutzen.

Austrotherm Rahmenprofil

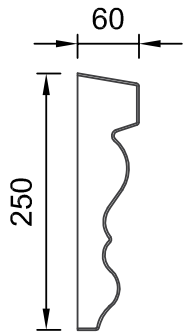

Art.Nr.: FFXABN

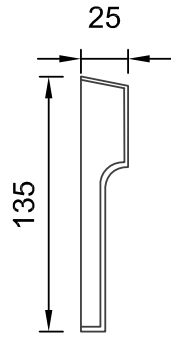

Art.Nr.: FFXABR

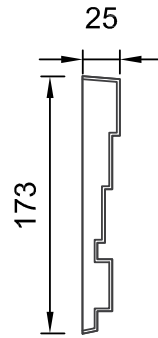

Art.Nr.: FFXABV

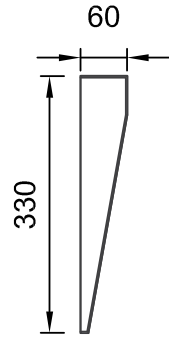

Art.Nr.: FFXABZ

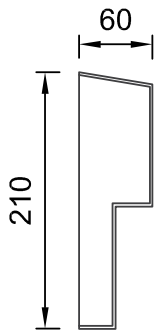

Art.Nr.: FFXABO

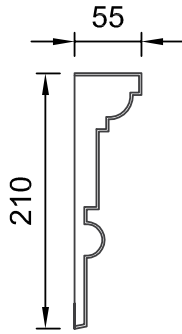

Art.Nr.: FFXABS

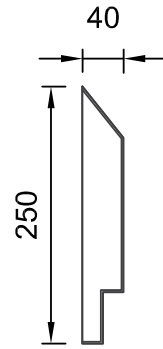

Art.Nr.: FFXABW

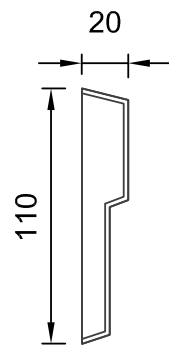

Art.Nr.: FFXACA

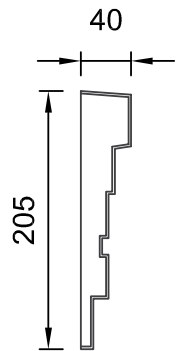

Art.Nr.: FFXABP

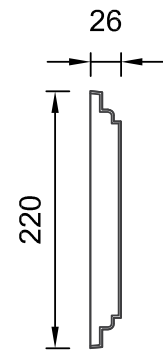

Art.Nr.: FFXABT

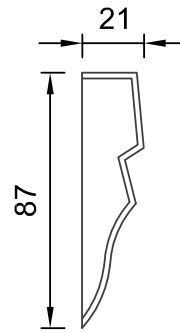

Art.Nr.: FFXABX

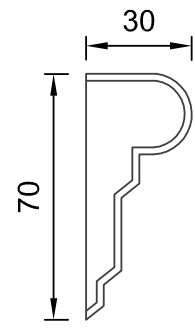

Art.Nr.: FFXACB

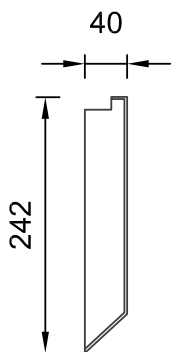

Art.Nr.: FFXABQ

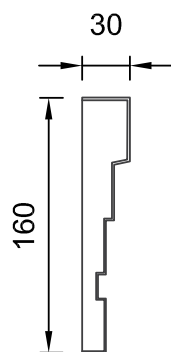

Art.Nr.: FFXABU

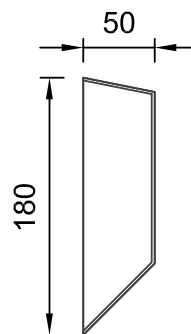

Art.Nr.: FFXABY

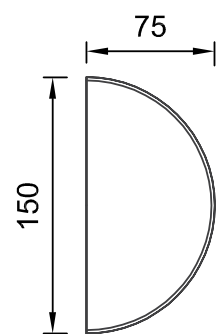

Art.Nr.: FFXACC



QR-Code einfach scannen und
Austrotherm Materialisten-Generator
online nutzen.

Austrotherm Rahmenprofil

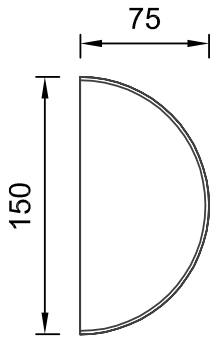

Art.Nr.: FFXACC

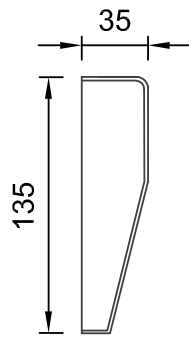

Art.Nr.: FFXACG

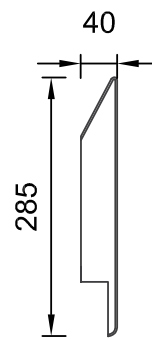

Art.Nr.: FFXACK

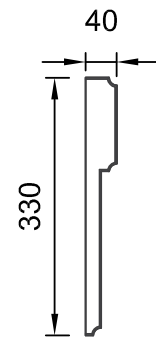

Art.Nr.: FFXACP

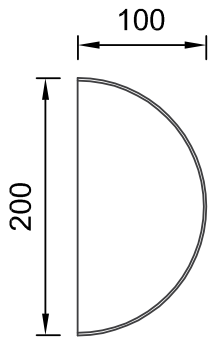

Art.Nr.: FFXACD

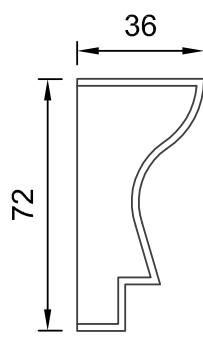

Art.Nr.: FFXACH

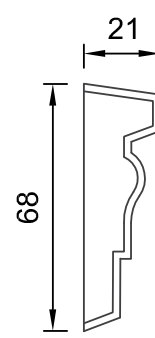

Art.Nr.: FFXACL

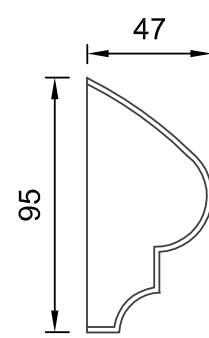

Art.Nr.: FFXACQ

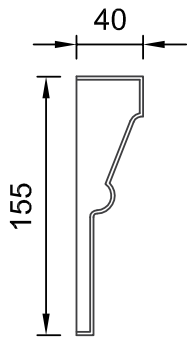

Art.Nr.: FFXACE

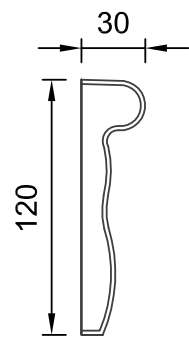

Art.Nr.: FFXACI

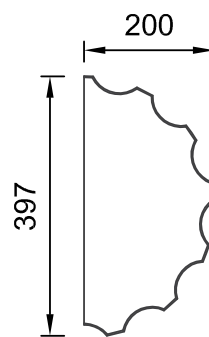

Art.Nr.: FFXACN

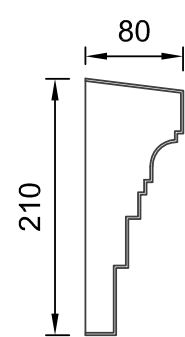

Art.Nr.: FFXACR

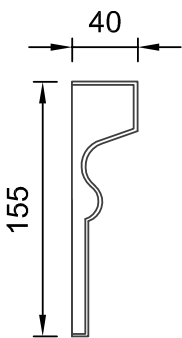

Art.Nr.: FFXACF

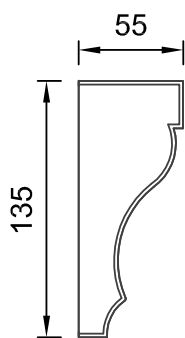

Art.Nr.: FFXACJ

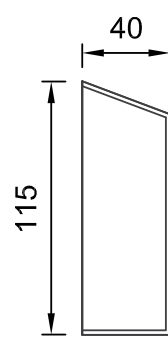

Art.Nr.: FFXACO

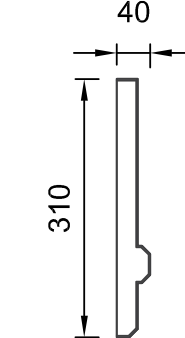

Art.Nr.: FFXACS



QR-Code einfach scannen und
Austrotherm Materialisten-Generator
online nutzen.

Austrotherm Rahmenprofil

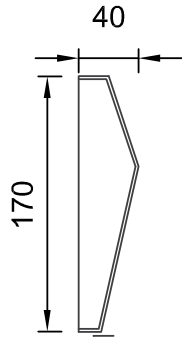

Art.Nr.: FFXACT

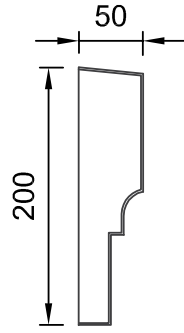

Art.Nr.: FFXACX

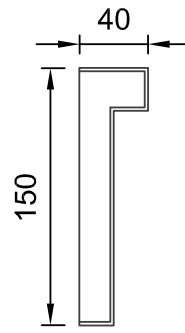

Art.Nr.: FFXADC

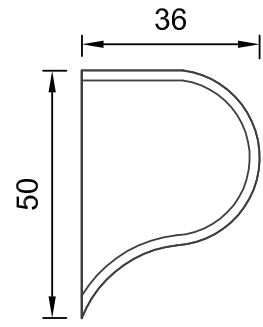

Art.Nr.: FFXADG

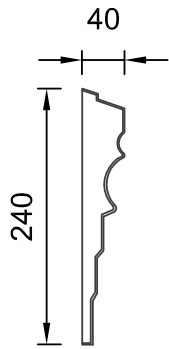

Art.Nr.: FFXACU

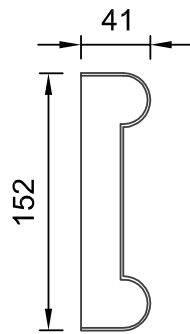

Art.Nr.: FFXACY

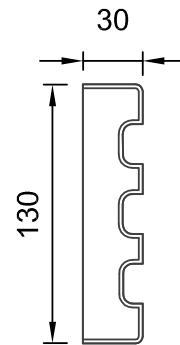

Art.Nr.: FFXADD

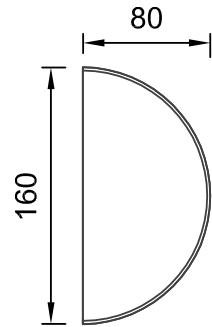

Art.Nr.: FFXADH

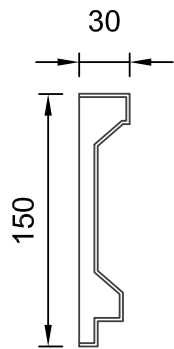

Art.Nr.: FFXACV

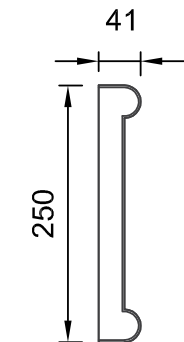

Art.Nr.: FFXACZ

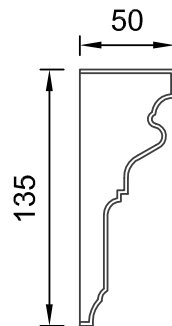

Art.Nr.: FFXADE

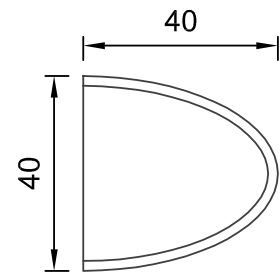

Art.Nr.: FFXADI

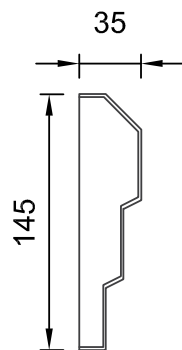

Art.Nr.: FFXACW

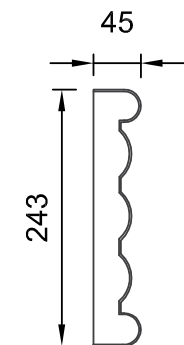

Art.Nr.: FFXADA

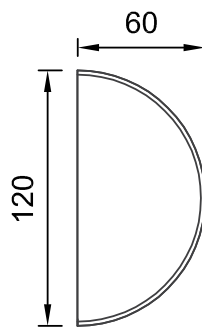

Art.Nr.: FFXADF

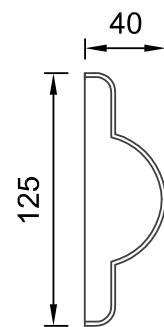

Art.Nr.: FFXADJ



QR-Code einfach scannen und
Austrotherm Materiallist-Generator
online nutzen.

Austrotherm Rahmenprofil

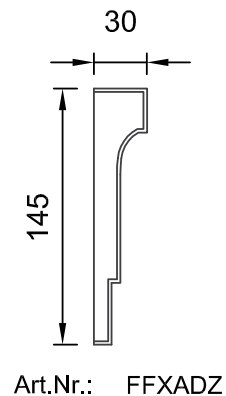
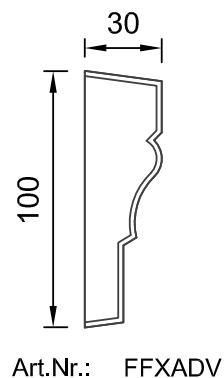
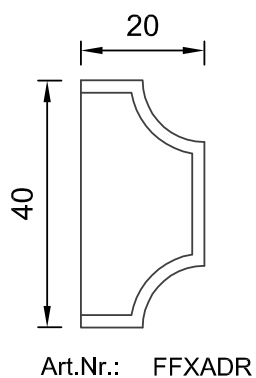
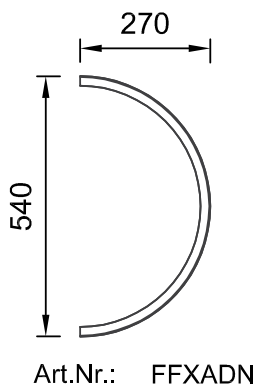
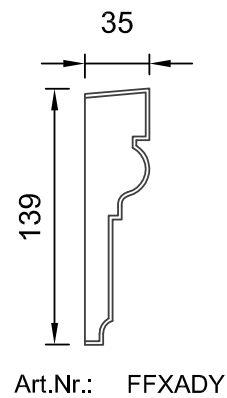
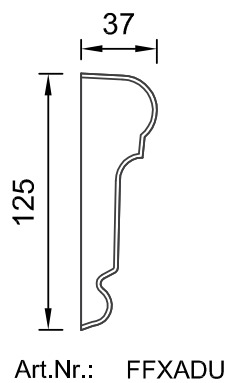
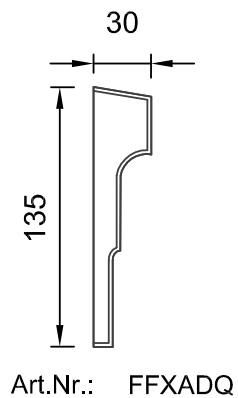
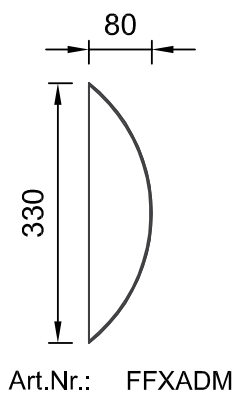
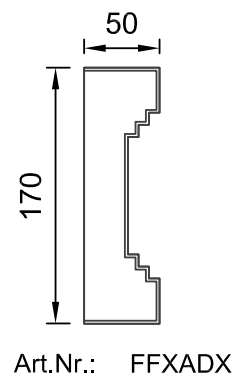
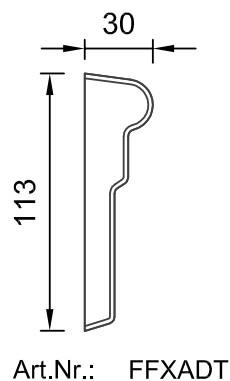
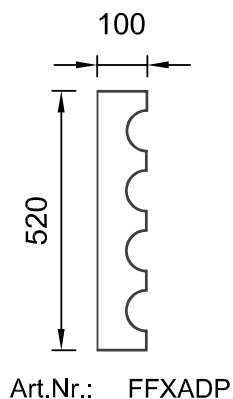
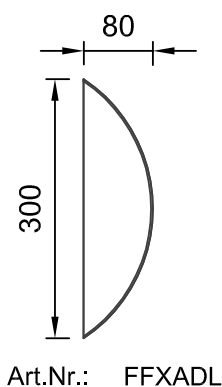
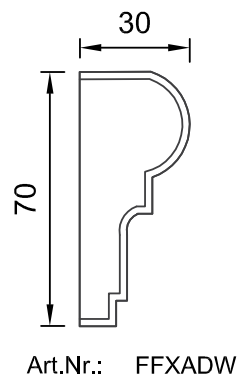
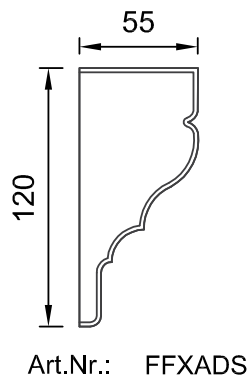
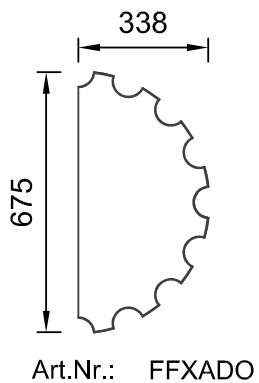
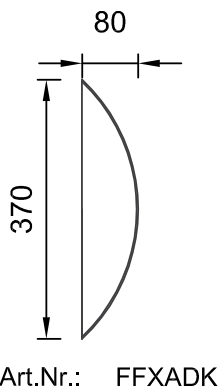

QR-Code einfach scannen und
Austrotherm Materialisten-Generator
online nutzen.

Austrotherm Rahmenprofil

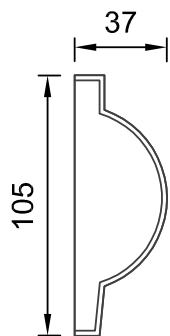

Art.Nr.: FFXAEA

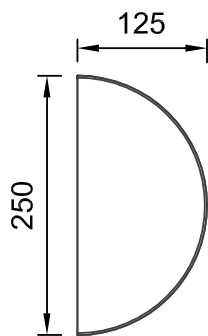

Art.Nr.: FFXAEE

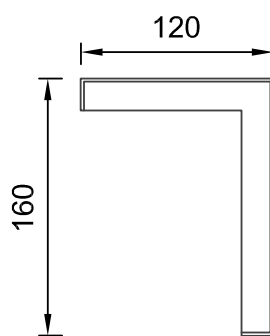

Art.Nr.: FFXAEI

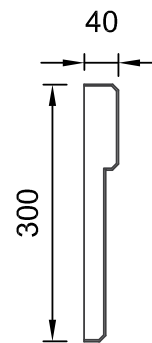

Art.Nr.: FFXAEM

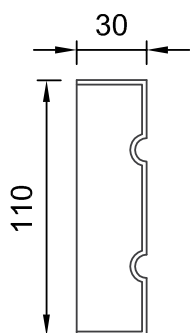

Art.Nr.: FFXAEB

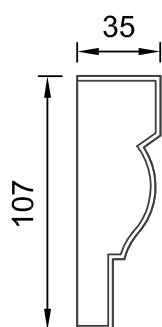

Art.Nr.: FFXAEF

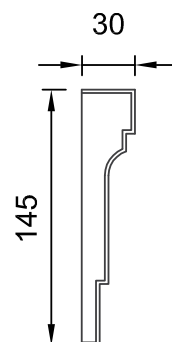

Art.Nr.: FFXAEJ

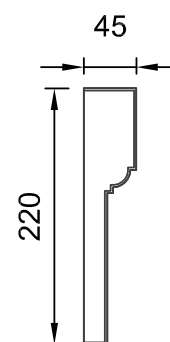

Art.Nr.: FFXAEO

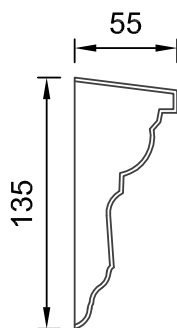

Art.Nr.: FFXAEC

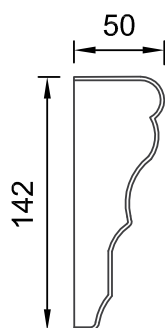

Art.Nr.: FFXAEG

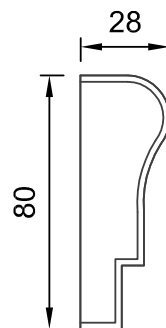

Art.Nr.: FFXAEK

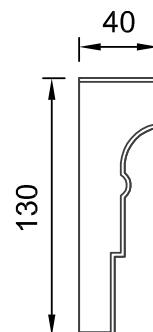

Art.Nr.: FFXAEP

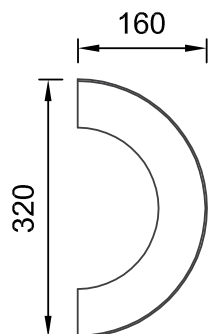

Art.Nr.: FFXAED

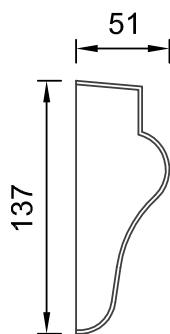

Art.Nr.: FFXAEH

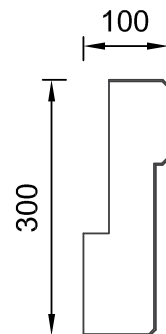

Art.Nr.: FFXAEL

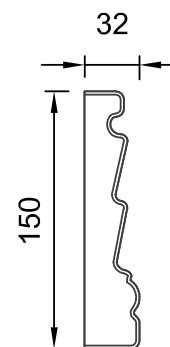

Art.Nr.: FFXAEQ



QR-Code einfach scannen und
Austrotherm Materiallisten-Generator
online nutzen.

Austrotherm Rahmenprofil

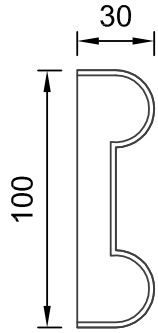

Art.Nr.: FFXAET

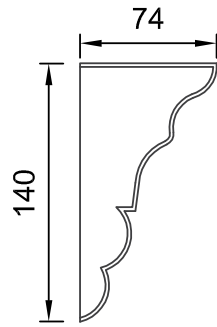

Art.Nr.: FFXAEX

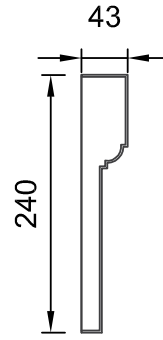

Art.Nr.: FFXAFB

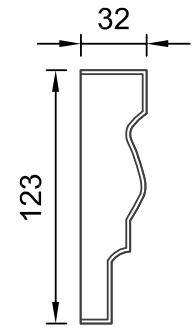

Art.Nr.: FFXAFF

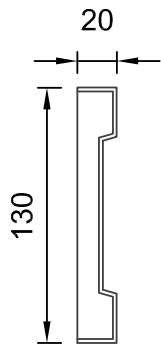

Art.Nr.: FFXAEU

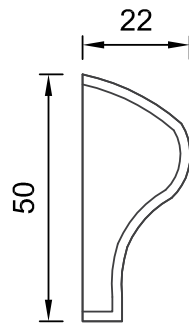

Art.Nr.: FFXAEY

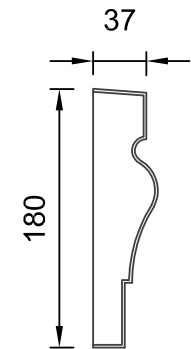
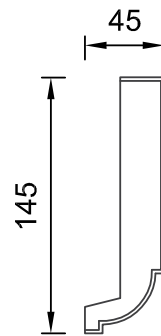

Art.Nr.: FFXAFG

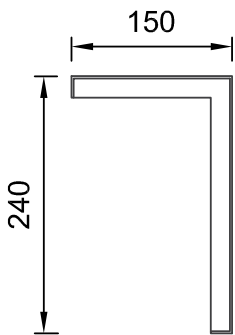

Art.Nr.: FFXAEV

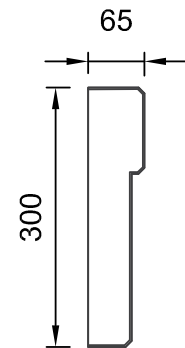

Art.Nr.: FFXAEZ

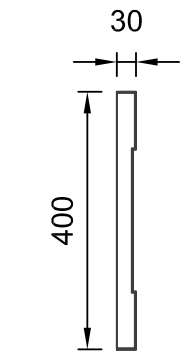
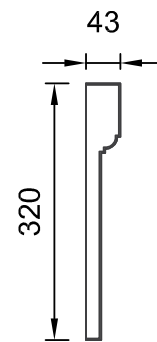

Art.Nr.: FFXAFH

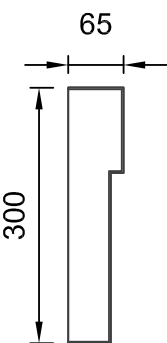

Art.Nr.: FFXAEW

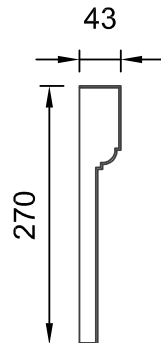

Art.Nr.: FFXAFA

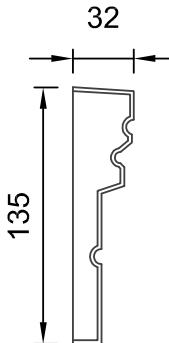

Art.Nr.: FFXAFE

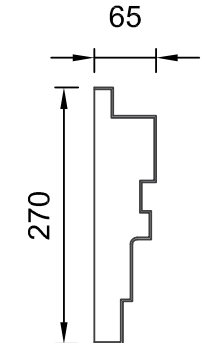

Art.Nr.: FFXAFI



QR-Code einfach scannen und
Austrotherm Materialisten-Generator
online nutzen.

Austrotherm Rahmenprofil

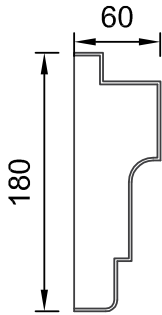

Art.Nr.: FFXAFJ

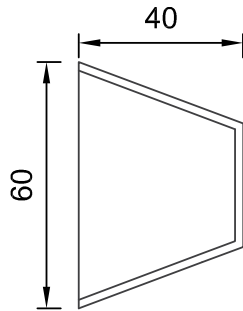

Art.Nr.: FFXAFN

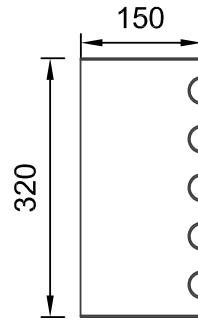

Art.Nr.: FFXAFR

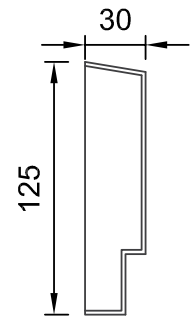

Art.Nr.: FFXAFV

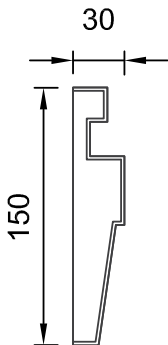

Art.Nr.: FFXAFK

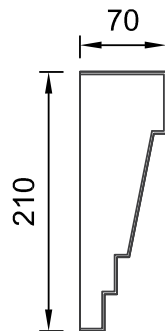

Art.Nr.: FFXAFO

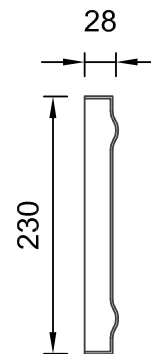

Art.Nr.: FFXAFS

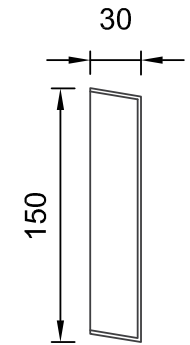

Art.Nr.: FFXAFW

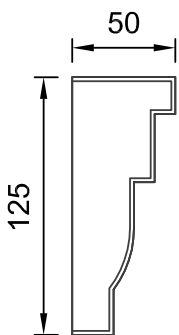

Art.Nr.: FFXAFL

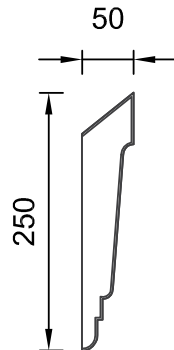

Art.Nr.: FFXAFP

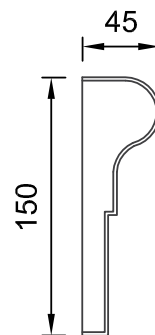

Art.Nr.: FFXAFT

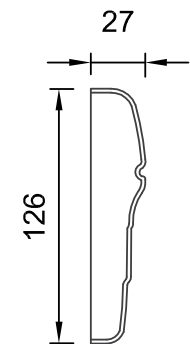

Art.Nr.: FFXAFX

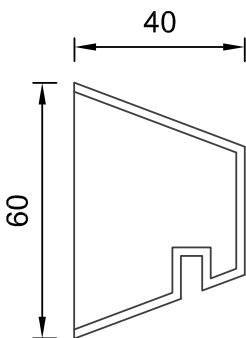

Art.Nr.: FFXAFM

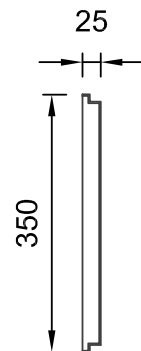

Art.Nr.: FFXAFQ

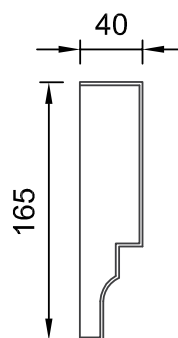

Art.Nr.: FFXAFU

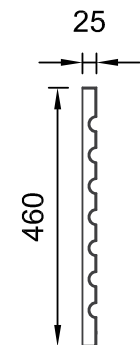

Art.Nr.: FFXAFY



QR-Code einfach scannen und
Austrotherm Materiallisten-Generator
online nutzen.

Austrotherm Rahmenprofil

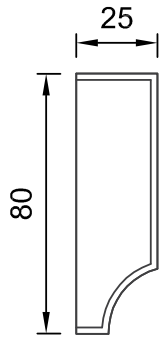

Art.Nr.: FFXAFZ

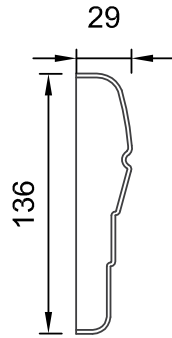

Art.Nr.: FFXAGD

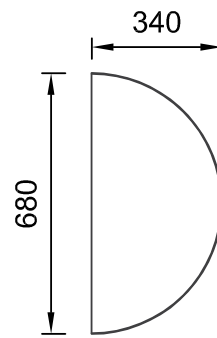

Art.Nr.: FFXAGI

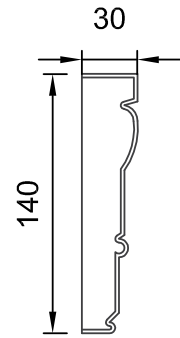

Art.Nr.: FFXAGW

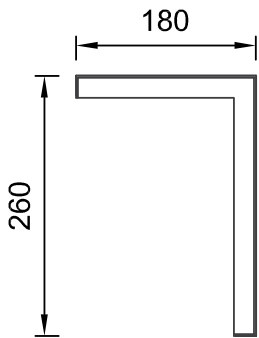

Art.Nr.: FFXAGA

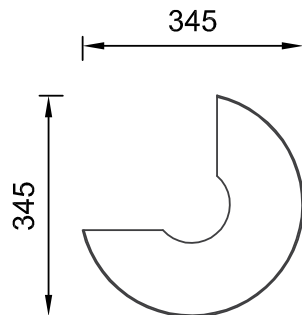

Art.Nr.: FFXAGE

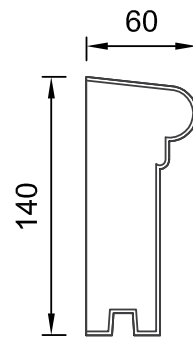

Art.Nr.: FFXAGJ

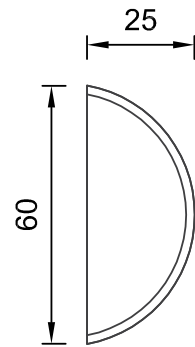

Art.Nr.: FFXAGX

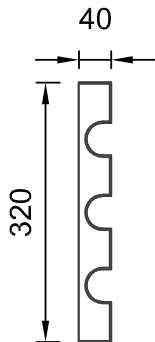

Art.Nr.: FFXAGB

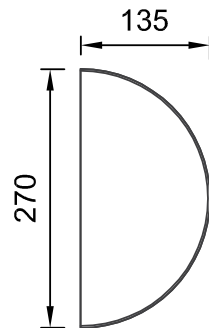

Art.Nr.: FFXAGG

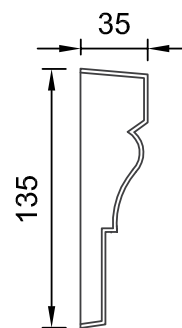

Art.Nr.: FFXAGO

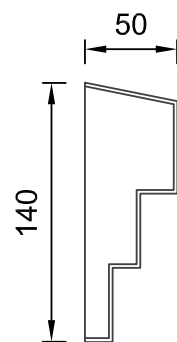

Art.Nr.: FFXAGY

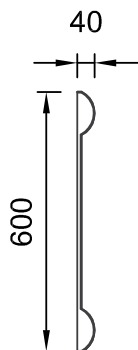

Art.Nr.: FFXAGC

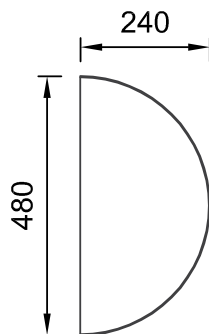

Art.Nr.: FFXAGH

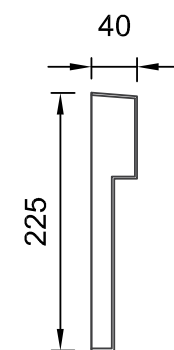

Art.Nr.: FFXAGR

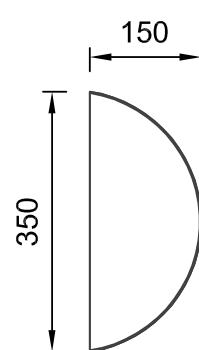

Art.Nr.: FFXAGZ



QR-Code einfach scannen und
Austrotherm Materiallisten-Generator
online nutzen.

Austrotherm Rahmenprofil

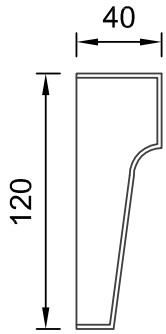

Art.Nr.: FFXAHA

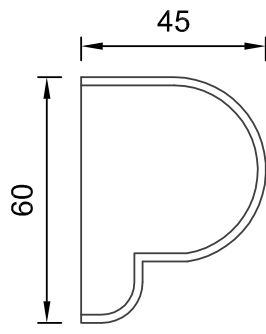

Art.Nr.: FFXAHM

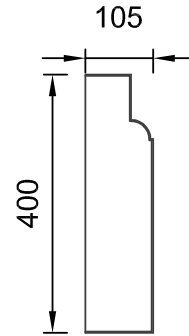

Art.Nr.: FFXAHU

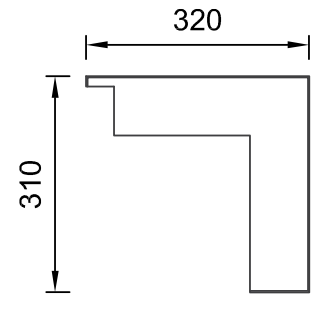

Art.Nr.: FFXAIB

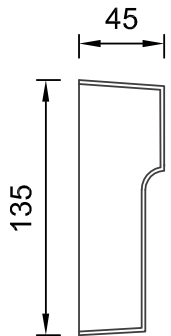

Art.Nr.: FFXAHC

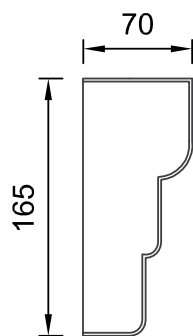

Art.Nr.: FFXAHN

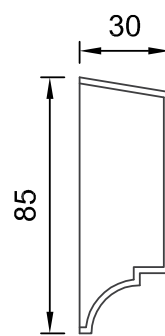

Art.Nr.: FFXAHV

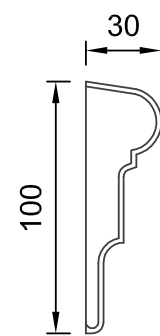

Art.Nr.: FFXAIC

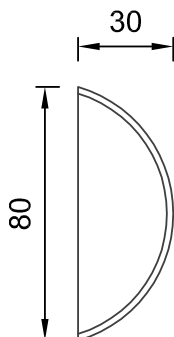

Art.Nr.: FFXAHE

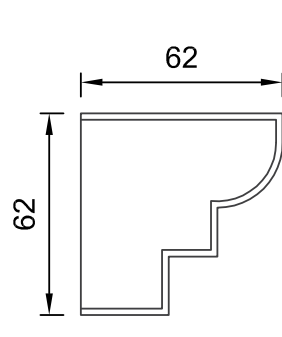

Art.Nr.: FFXAHP

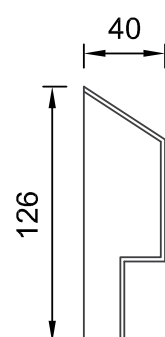

Art.Nr.: FFXAHW

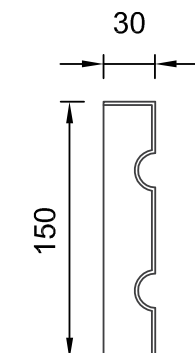

Art.Nr.: FFXAIH

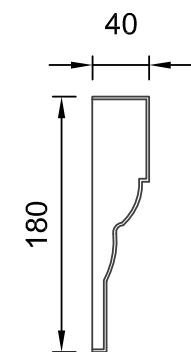

Art.Nr.: FFXAHL

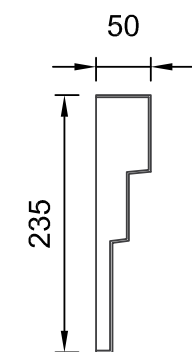

Art.Nr.: FFXAHR

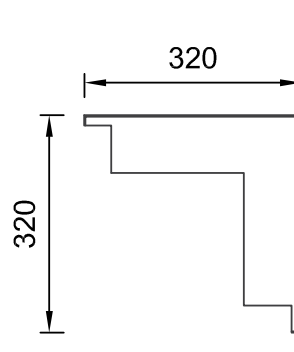

Art.Nr.: FFXAIA

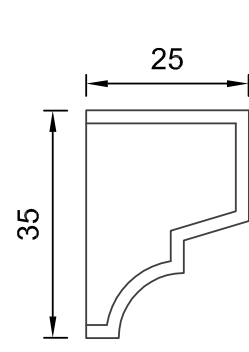

Art.Nr.: FFXAIJ



QR-Code einfach scannen und
Austrotherm Materiallisten-Generator
online nutzen.

Austrotherm Rahmenprofil

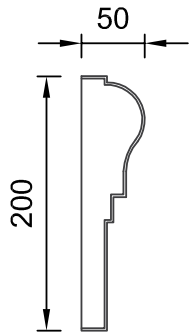

Art.Nr.: FFXAIK

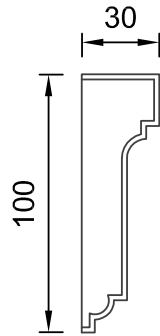

Art.Nr.: FFXAIP

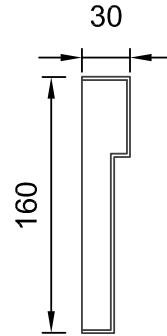

Art.Nr.: FFXAIV

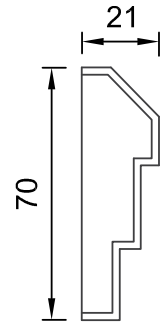

Art.Nr.: FFXAJE

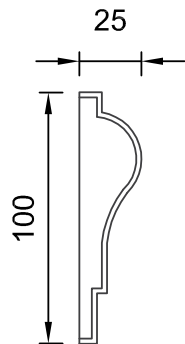

Art.Nr.: FFXAIM

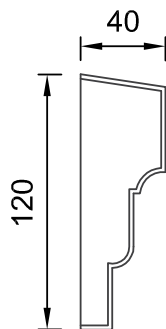

Art.Nr.: FFXAIQ

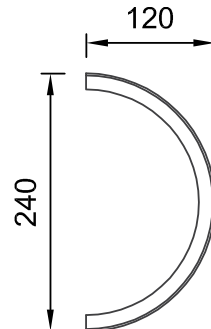

Art.Nr.: FFXAIY

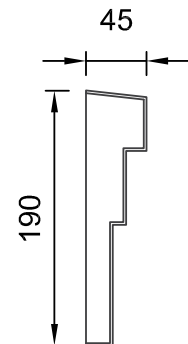

Art.Nr.: FFXAJJ

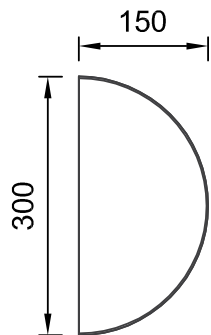

Art.Nr.: FFXAIN

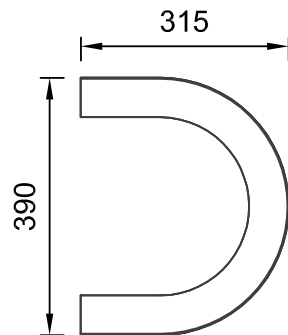

Art.Nr.: FFXAIS

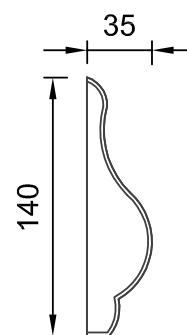

Art.Nr.: FFXAJB

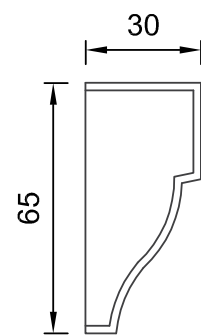

Art.Nr.: FFXAJO

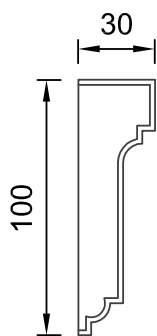

Art.Nr.: FFXAIP

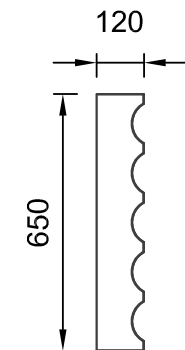

Art.Nr.: FFXAIT

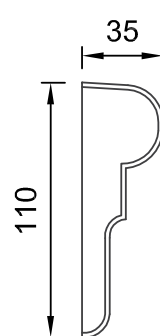

Art.Nr.: FFXAJD

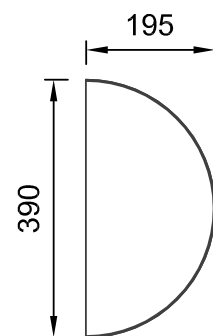

Art.Nr.: FFXAJQ



QR-Code einfach scannen und
Austrotherm Materiallist-Generator
online nutzen.

Austrotherm Rahmenprofil

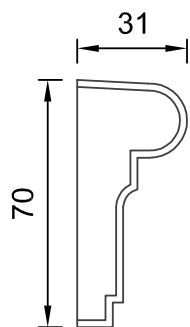

Art.Nr.: FFXAJR

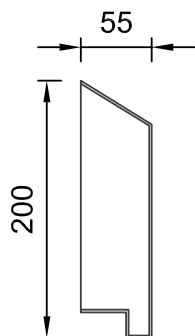

Art.Nr.: FFXAKD

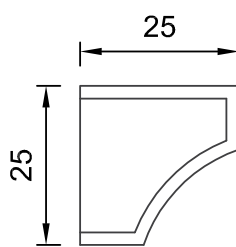

Art.Nr.: FFXAKJ

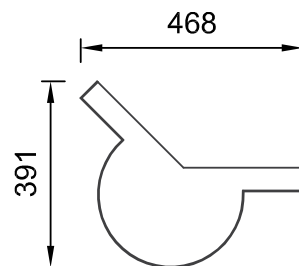

Art.Nr.: FFXAKN

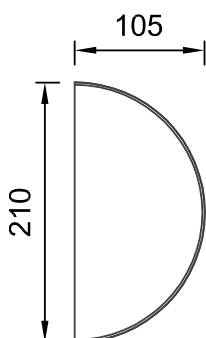

Art.Nr.: FFXAJS

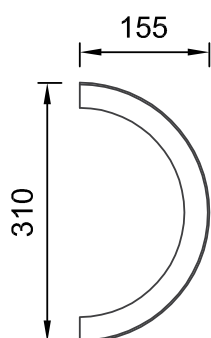

Art.Nr.: FFXAKE

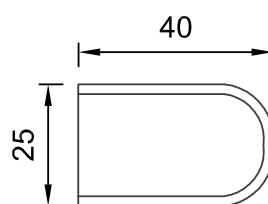

Art.Nr.: FFXAKK

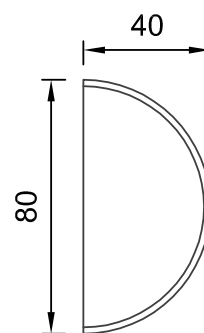

Art.Nr.: FFXAKO

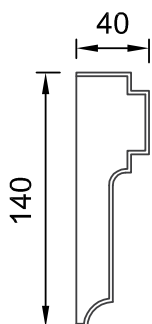

Art.Nr.: FFXAJT

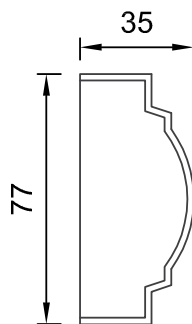

Art.Nr.: FFXAKH

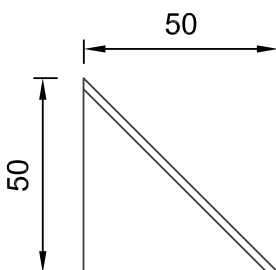

Art.Nr.: FFXAKL

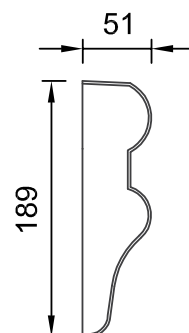

Art.Nr.: FFXAKP

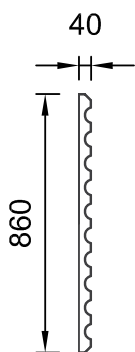

Art.Nr.: FFXAJX

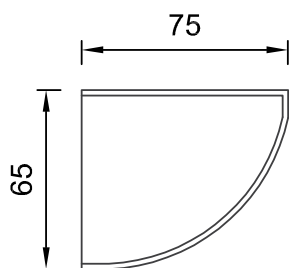

Art.Nr.: FFXAKI

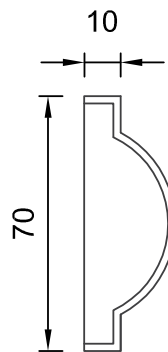

Art.Nr.: FFXAKM

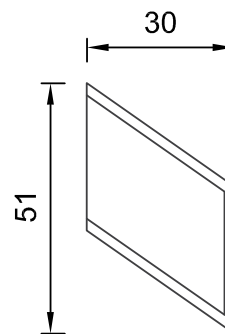

Art.Nr.: FFXAKU



QR-Code einfach scannen und
Austrotherm Materialisten-Generator
online nutzen.

Austrotherm Rahmenprofil

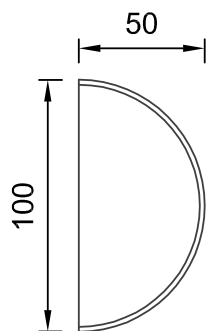

Art.Nr.: FFXALA

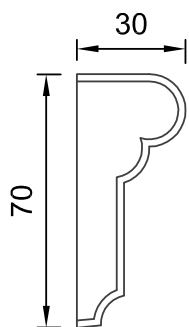

Art.Nr.: FFXALN

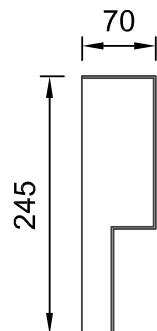

Art.Nr.: FFXALZ

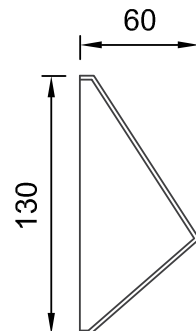

Art.Nr.: FFXAMH

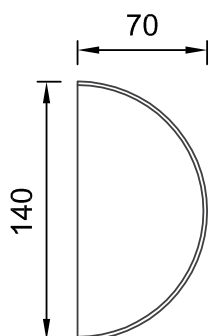

Art.Nr.: FFXALB

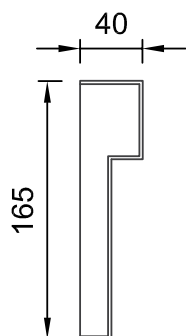

Art.Nr.: FFXALP

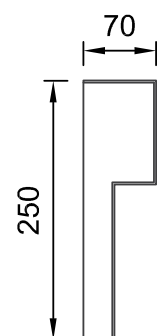

Art.Nr.: FFXAMA

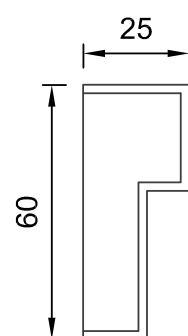

Art.Nr.: FFXAML

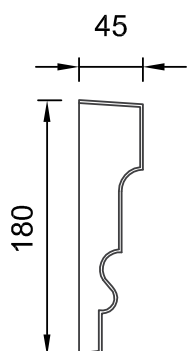

Art.Nr.: FFXALI

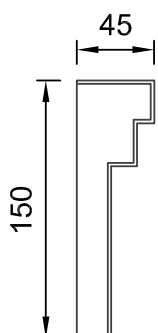

Art.Nr.: FFXALQ

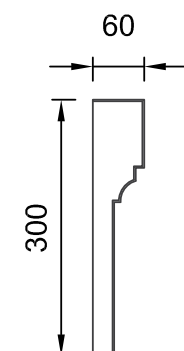

Art.Nr.: FFXAME

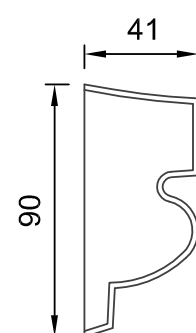

Art.Nr.: FFXAMO

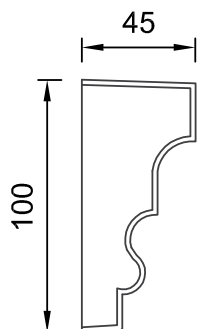

Art.Nr.: FFXALJ

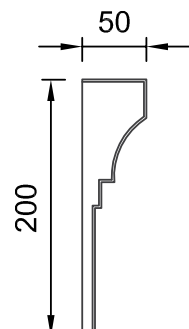

Art.Nr.: FFXALS

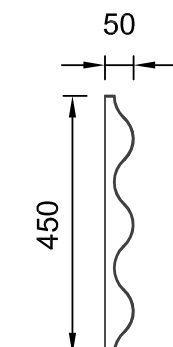

Art.Nr.: FFXAMG

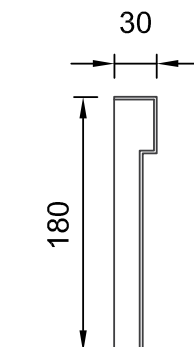

Art.Nr.: FFXAMX



QR-Code einfach scannen und
Austrotherm Materialisten-Generator
online nutzen.

Austrotherm Rahmenprofil

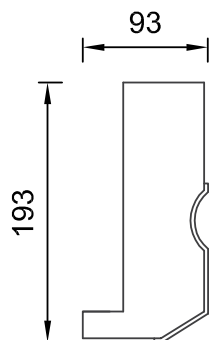

Art.Nr.: FFXAMZ

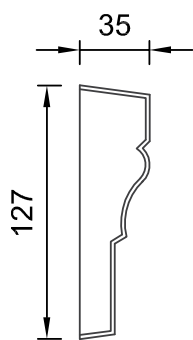

Art.Nr.: FFXANK

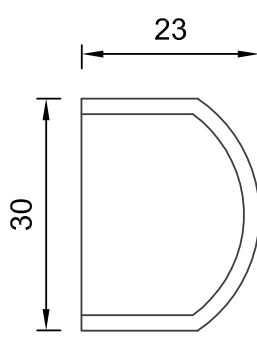

Art.Nr.: FFXANQ

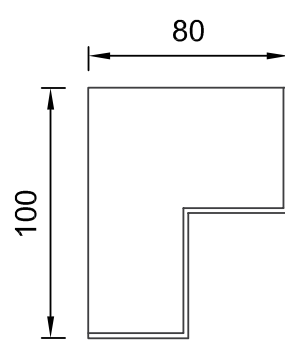

Art.Nr.: FFXAOE

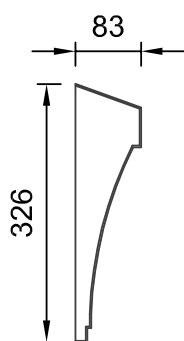

Art.Nr.: FFXANA

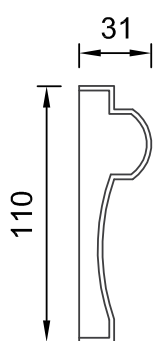

Art.Nr.: FFXANN

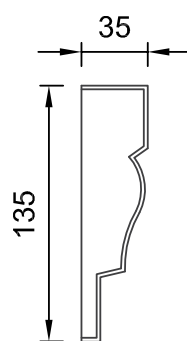

Art.Nr.: FFXANU

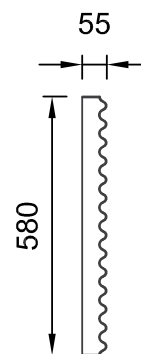

Art.Nr.: FFXAOF

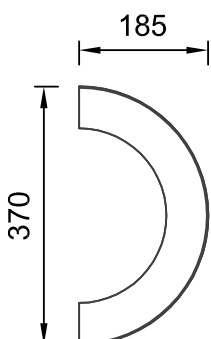

Art.Nr.: FFXAND

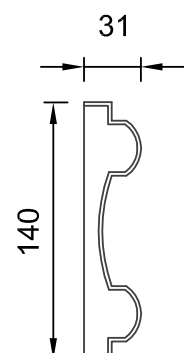

Art.Nr.: FFXANO

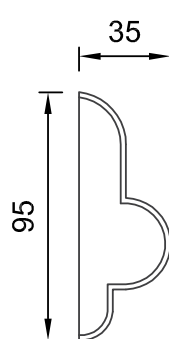

Art.Nr.: FFXAOB

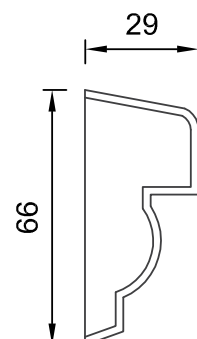

Art.Nr.: FFXAOH

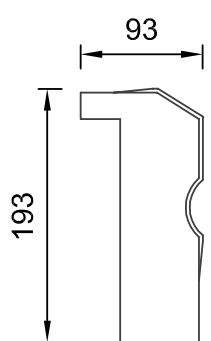

Art.Nr.: FFXANJ

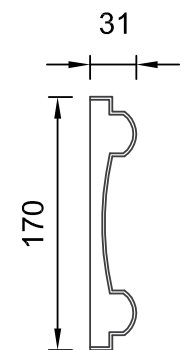

Art.Nr.: FFXANP

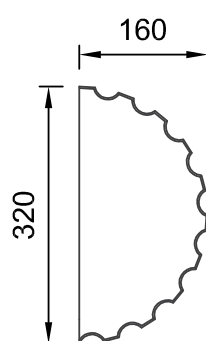

Art.Nr.: FFXAOD

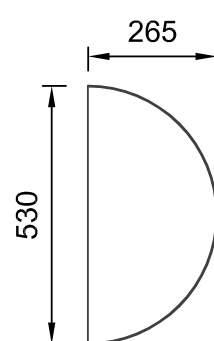

Art.Nr.: FFXAON



QR-Code einfach scannen und
Austrotherm Materialisten-Generator
online nutzen.

Austrotherm Rahmenprofil

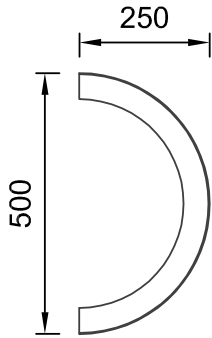

Art.Nr.: FFXAOQ

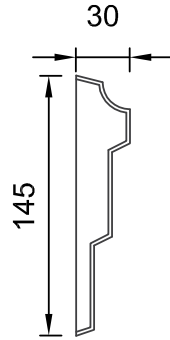

Art.Nr.: FFXAOW

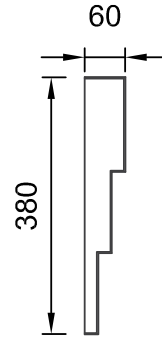

Art.Nr.: FFXAPJ

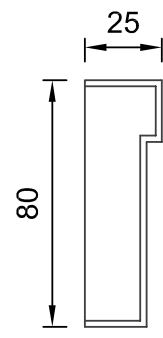

Art.Nr.: FFXAPO

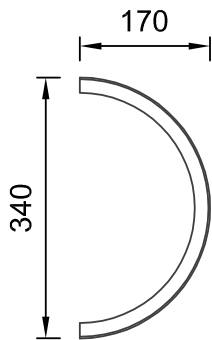

Art.Nr.: FFXAOR

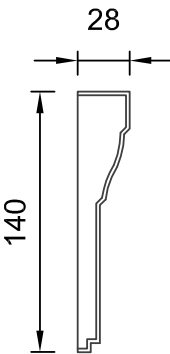

Art.Nr.: FFXAOX

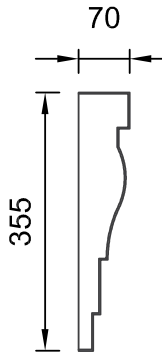

Art.Nr.: FFXAPL

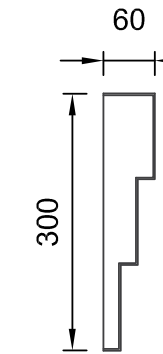

Art.Nr.: FFXAPR

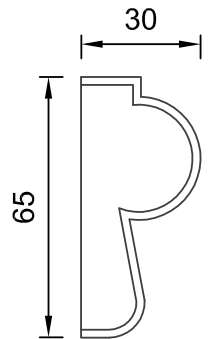

Art.Nr.: FFXAOU

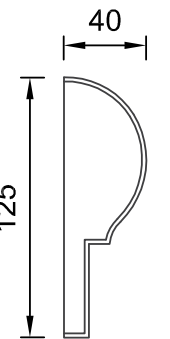

Art.Nr.: FFXAOY

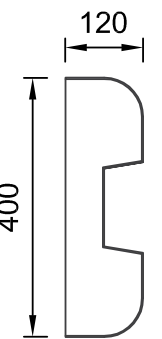

Art.Nr.: FFXAPM

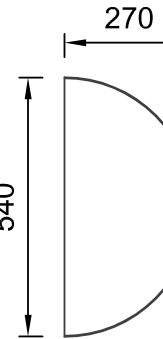

Art.Nr.: FFXAPT

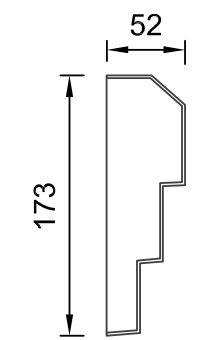

Art.Nr.: FFXAOV

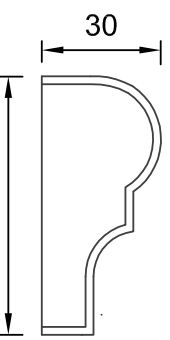

Art.Nr.: FFXAPE

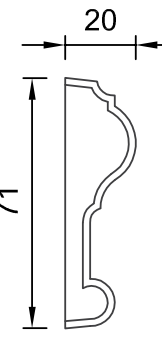

Art.Nr.: FFXAPN

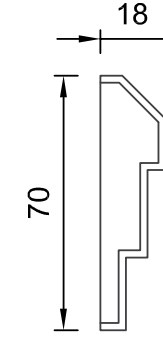

Art.Nr.: FFXAPU



QR-Code einfach scannen und
Austrotherm Materiallisten-Generator
online nutzen.

Austrotherm Rahmenprofil

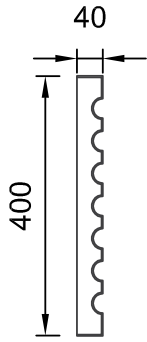

Art.Nr.: FFXAPV

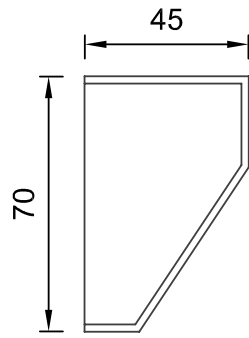

Art.Nr.: FFXAQB

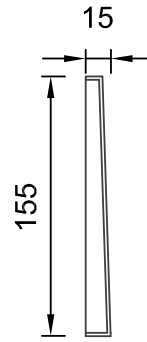

Art.Nr.: FFXAQZ

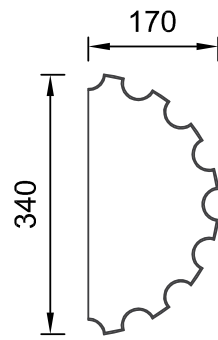

Art.Nr.: FFXARH

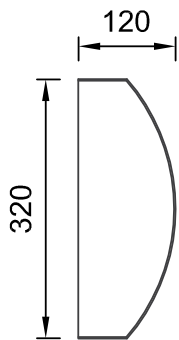

Art.Nr.: FFXAPX

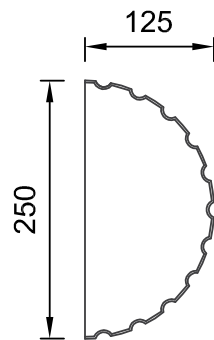

Art.Nr.: FFXAQU

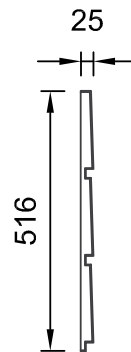

Art.Nr.: FFXARD

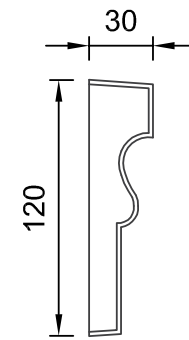

Art.Nr.: FFXARI

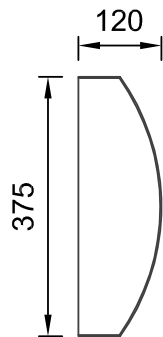

Art.Nr.: FFXAPY

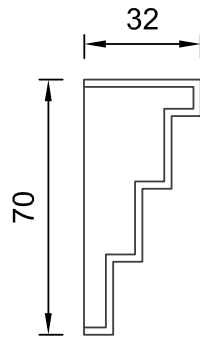

Art.Nr.: FFXAQV

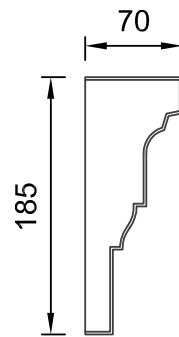

Art.Nr.: FFXARE

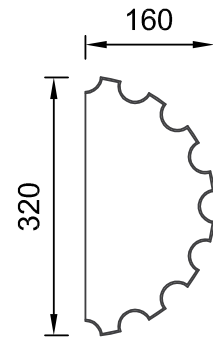

Art.Nr.: FFXARK

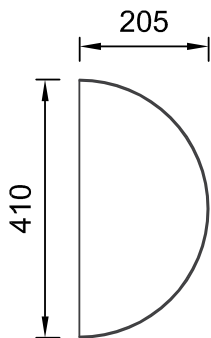

Art.Nr.: FFXAQA

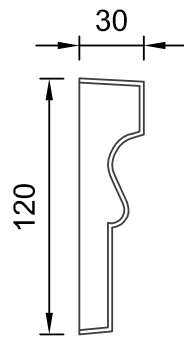

Art.Nr.: FFXAQX

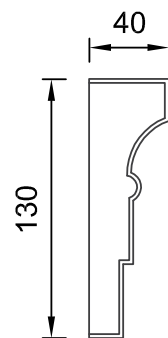

Art.Nr.: FFXARF

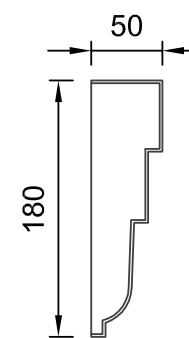

Art.Nr.: FFXARQ



QR-Code einfach scannen und
Austrotherm Materiallisten-Generator
online nutzen.

Austrotherm Rahmenprofil

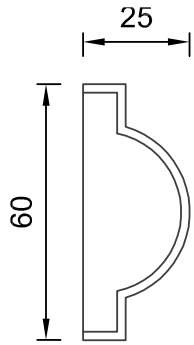

Art.Nr.: FFXARR

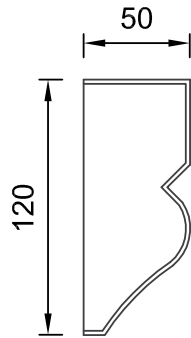

Art.Nr.: FFXARX

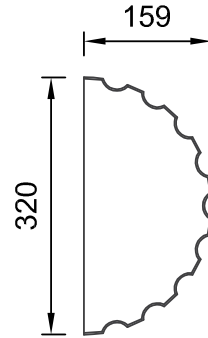

Art.Nr.: FFXASB

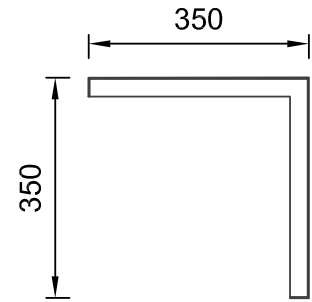

Art.Nr.: FFXASJ

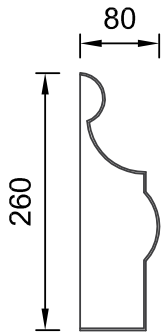

Art.Nr.: FFXARS

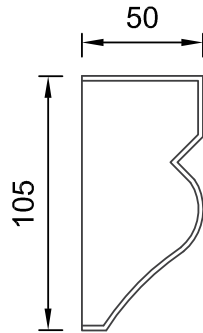

Art.Nr.: FFXARY

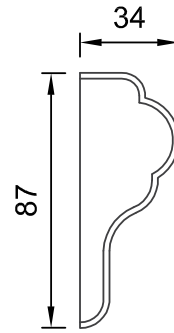

Art.Nr.: FFXASD

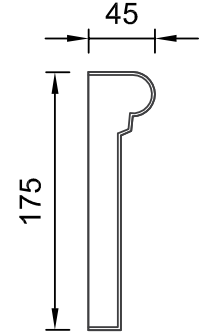

Art.Nr.: FFXASK

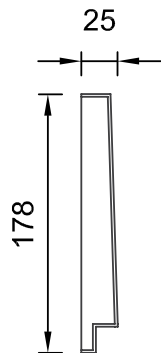

Art.Nr.: FFXART

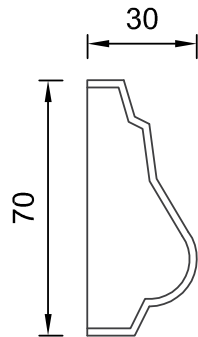

Art.Nr.: FFXARZ

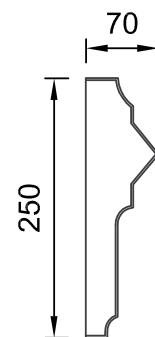

Art.Nr.: FFXASE

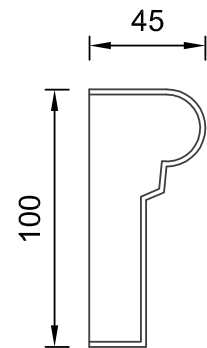

Art.Nr.: FFXASL

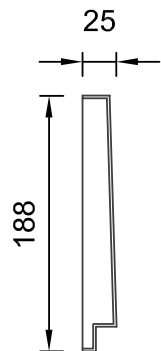

Art.Nr.: FFXARU

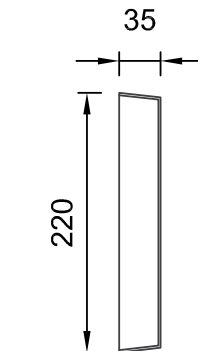

Art.Nr.: FFXASA

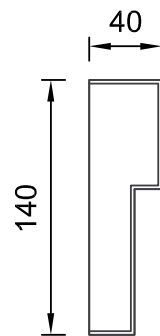

Art.Nr.: FFXASI

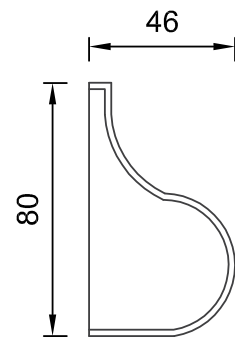

Art.Nr.: FFXASQ



QR-Code einfach scannen und
Austrotherm Materiallisten-Generator
online nutzen.

Austrotherm Rahmenprofil

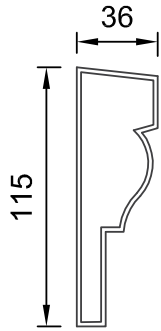

Art.Nr.: FFXASS

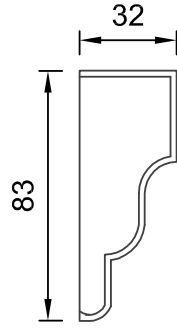

Art.Nr.: FFXATY

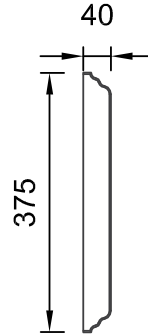

Art.Nr.: FFXAUG

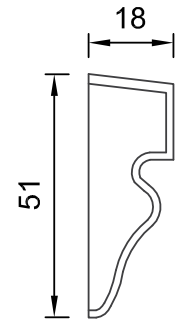

Art.Nr.: FFXAUQ

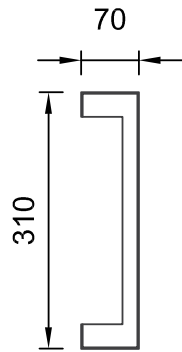

Art.Nr.: FFXATD

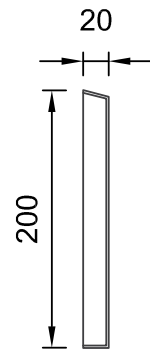

Art.Nr.: FFXATZ

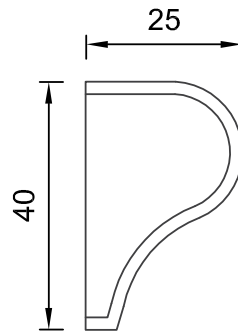

Art.Nr.: FFXAUL

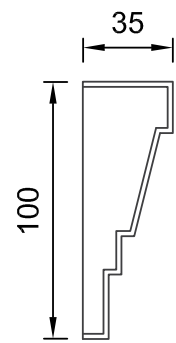

Art.Nr.: FFXAUX

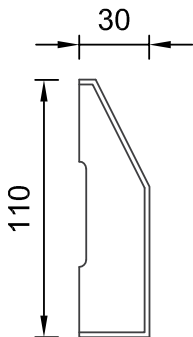

Art.Nr.: FFXATO

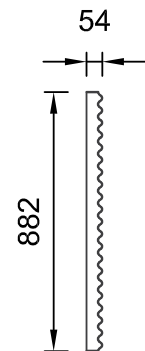

Art.Nr.: FFXAUE

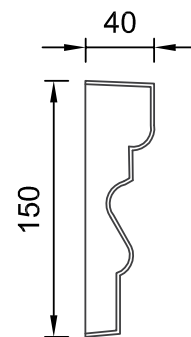

Art.Nr.: FFXAUO

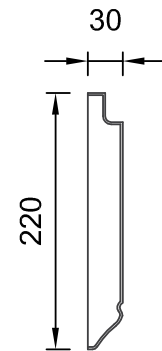

Art.Nr.: FFXAUY

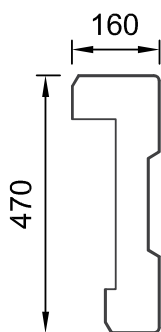

Art.Nr.: FFXATX

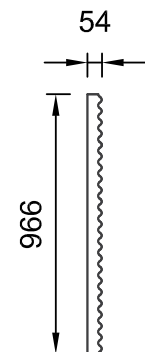

Art.Nr.: FFXAUF

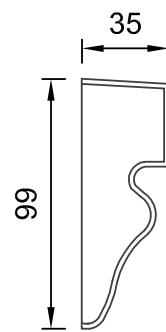

Art.Nr.: FFXAUP

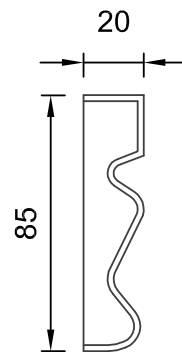

Art.Nr.: FFXAVB



QR-Code einfach scannen und
Austrotherm Materialisten-Generator
online nutzen.

Austrotherm Rahmenprofil

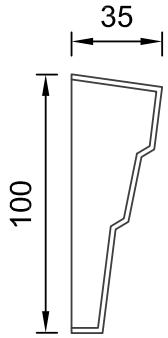

Art.Nr.: FFXAVC

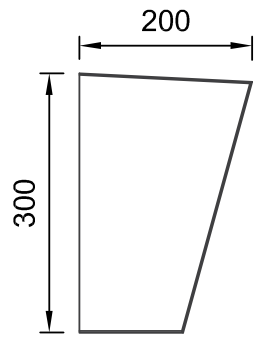

Art.Nr.: FFXAWB

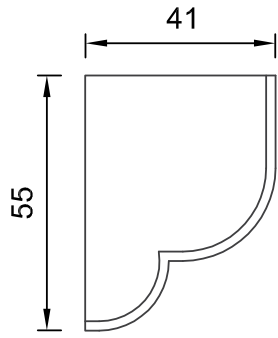

Art.Nr.: FFXAWI

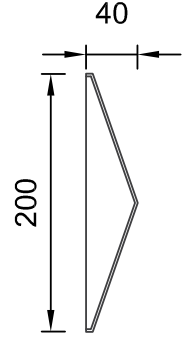

Art.Nr.: FFXAWT

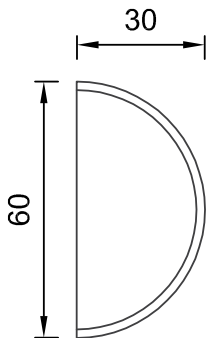

Art.Nr.: FFXAVE

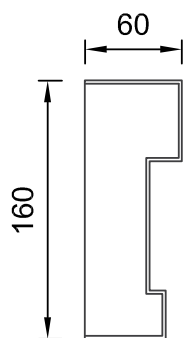

Art.Nr.: FFXAWD

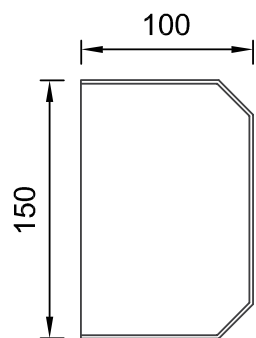

Art.Nr.: FFXAWJ

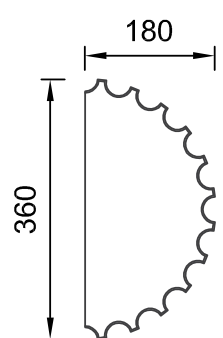

Art.Nr.: FFXAWU

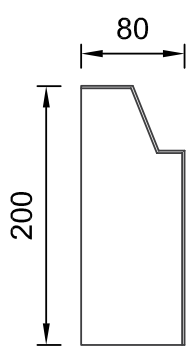

Art.Nr.: FFXAVS

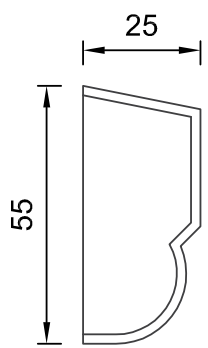

Art.Nr.: FFXAWF

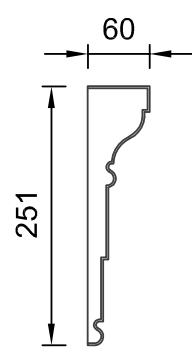

Art.Nr.: FFXAWM

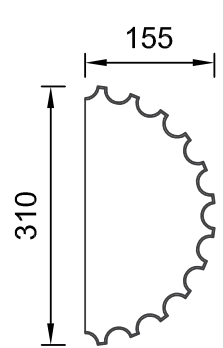

Art.Nr.: FFXAWV

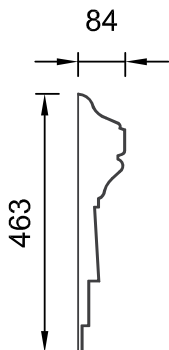

Art.Nr.: FFXAVV

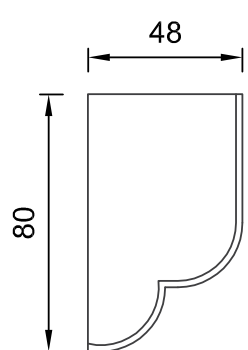

Art.Nr.: FFXAWH

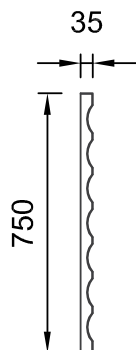

Art.Nr.: FFXAWQ

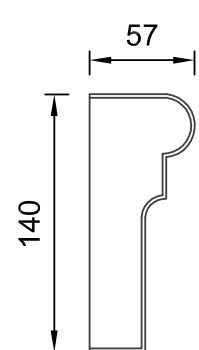

Art.Nr.: FFXAXB



QR-Code einfach scannen und
Austrotherm Materialisten-Generator
online nutzen.

Austrotherm Rahmenprofil

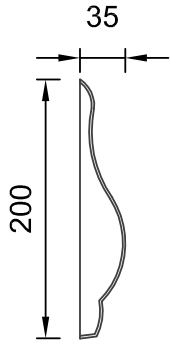

Art.Nr.: FFXAXO

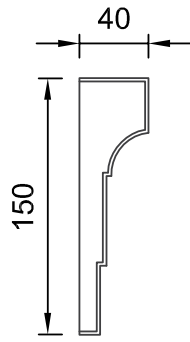

Art.Nr.: FFXAXV

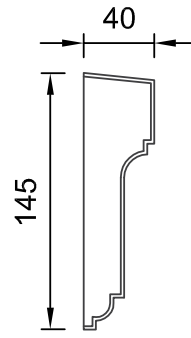

Art.Nr.: FFXAYP

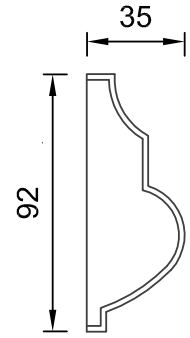

Art.Nr.: FFXAZC

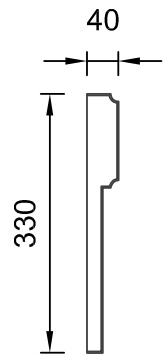

Art.Nr.: FFXAXQ

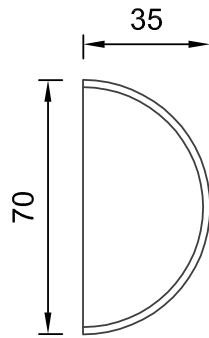

Art.Nr.: FFXAYA

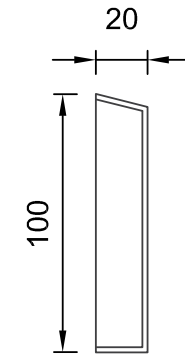

Art.Nr.: FFXAYU

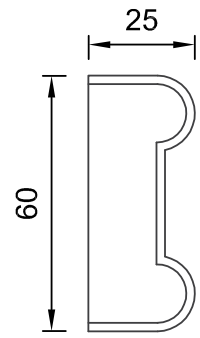

Art.Nr.: FFXAZE

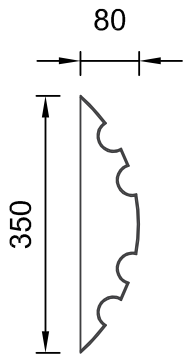

Art.Nr.: FFXAXR

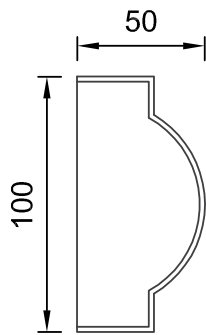

Art.Nr.: FFXAYB

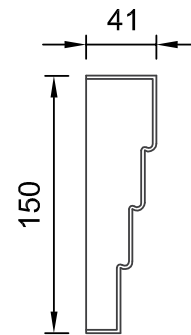

Art.Nr.: FFXAYV

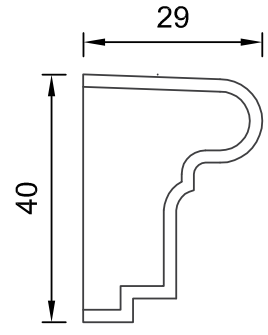

Art.Nr.: FFXAZF

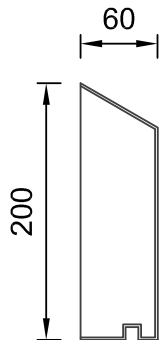

Art.Nr.: FFXAXU

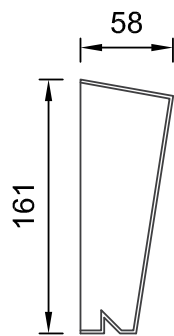

Art.Nr.: FFXAYN

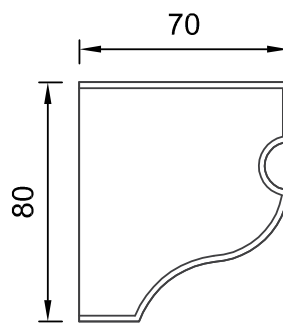

Art.Nr.: FFXAZA

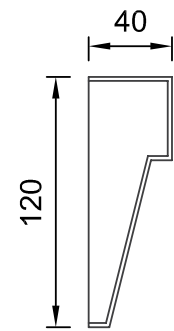

Art.Nr.: FFXAZJ



QR-Code einfach scannen und
Austrotherm Materiallisten-Generator
online nutzen.

Austrotherm Rahmenprofil

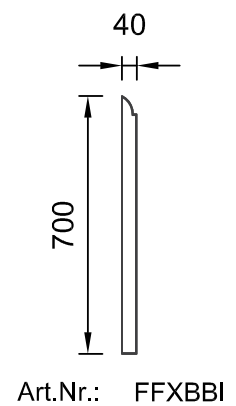
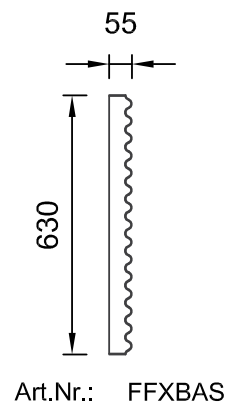
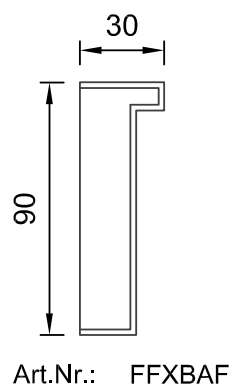
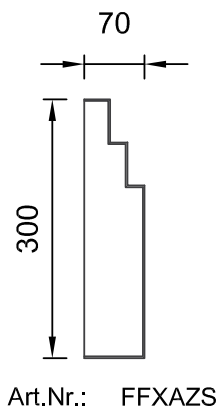
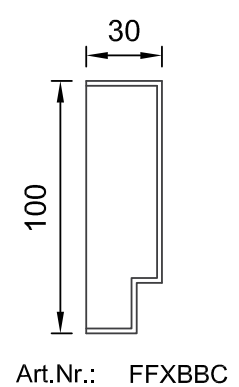
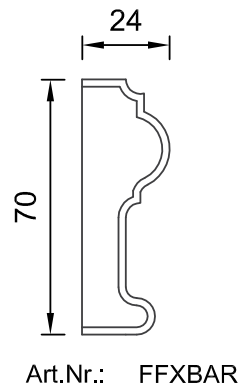
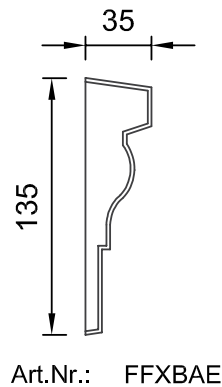
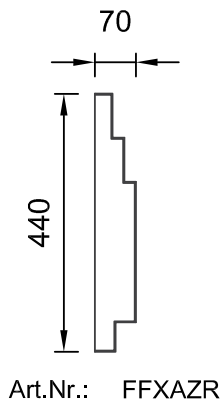
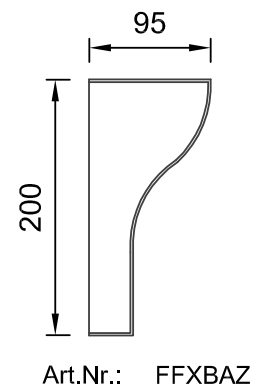
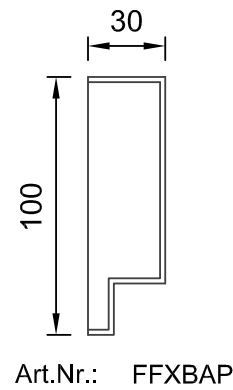
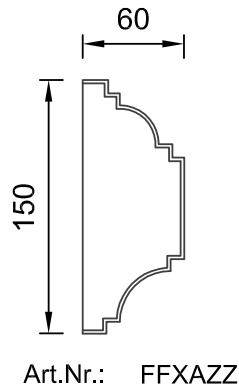
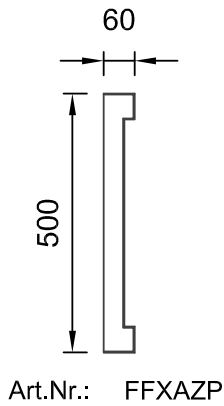
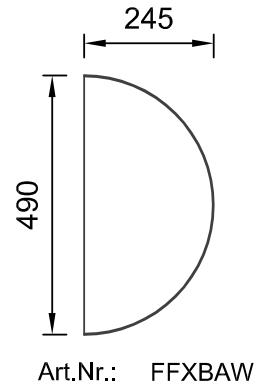
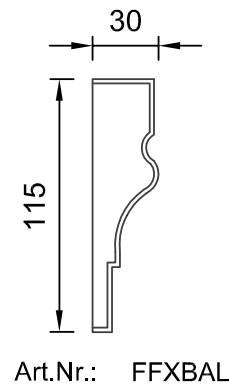
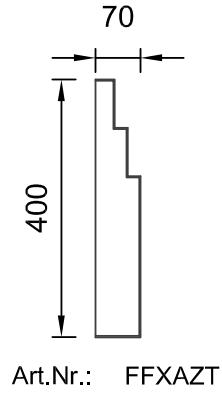
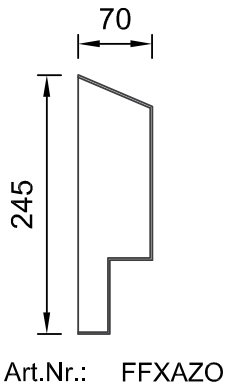

QR-Code einfach scannen und
Austrotherm Materialisten-Generator
online nutzen.

Austrotherm Rahmenprofil

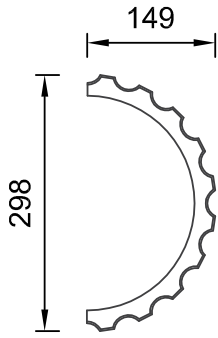

Art.Nr.: FFXBBK

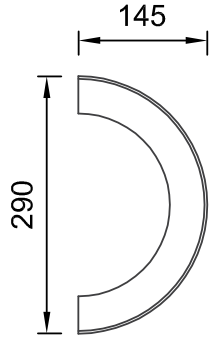

Art.Nr.: FFXBBQ

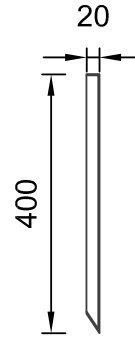

Art.Nr.: FFXBBW

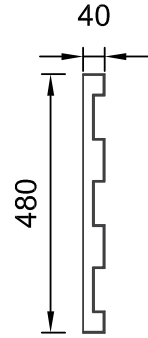

Art.Nr.: FFXBCC

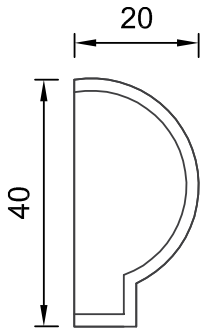

Art.Nr.: FFXBBM

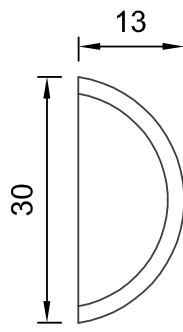

Art.Nr.: FFXBBR

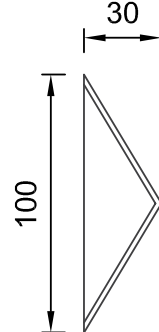

Art.Nr.: FFXBBX

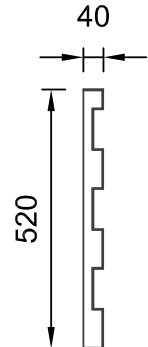

Art.Nr.: FFXBCD

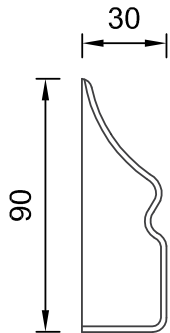

Art.Nr.: FFXBBN

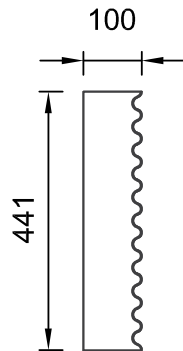

Art.Nr.: FFXBBS

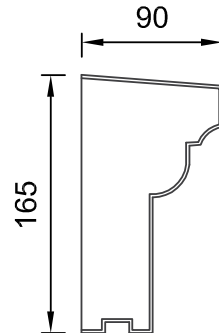

Art.Nr.: FFXBCA

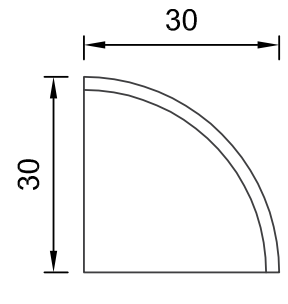

Art.Nr.: FFXBCG

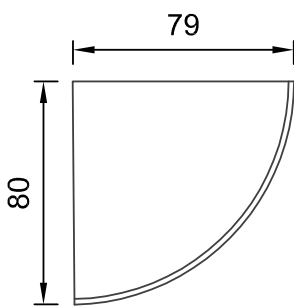

Art.Nr.: FFXBBP

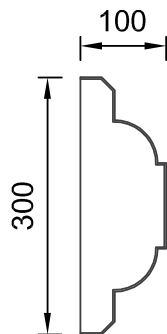

Art.Nr.: FFXBBV

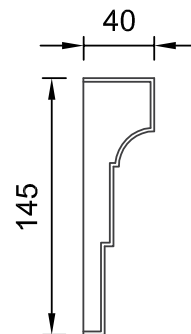

Art.Nr.: FFXBCB

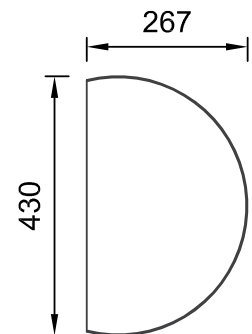

Art.Nr.: FFXBCJ



QR-Code einfach scannen und
Austrotherm Materialisten-Generator
online nutzen.

Austrotherm Rahmenprofil

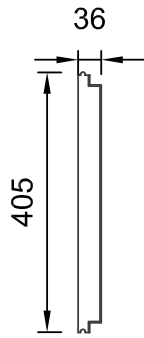

Art.Nr.: FFXBCL

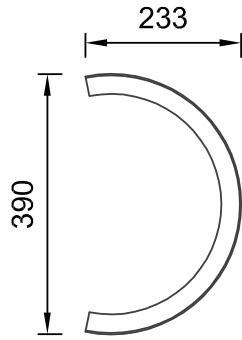

Art.Nr.: FFXBDA

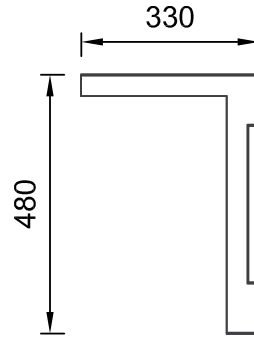

Art.Nr.: FFXBDG

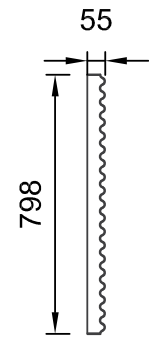

Art.Nr.: FFXBDO

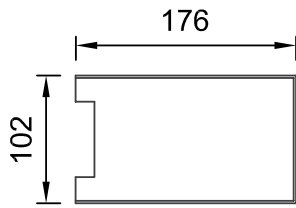

Art.Nr.: FFXBCU

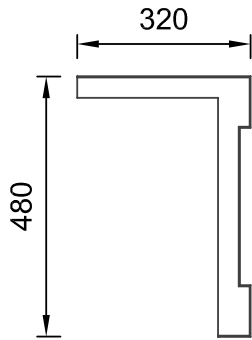

Art.Nr.: FFXBDB

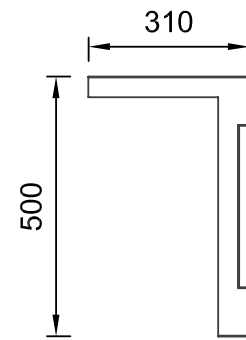

Art.Nr.: FFXBDH

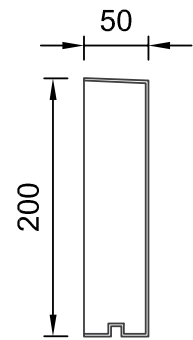

Art.Nr.: FFXBDQ

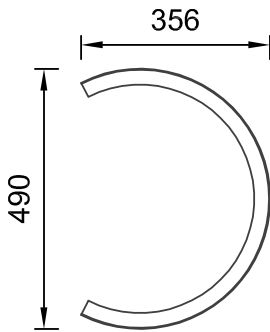

Art.Nr.: FFXBCY

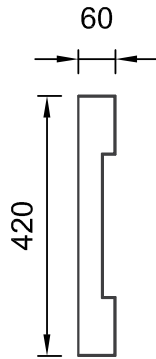

Art.Nr.: FFXBDD

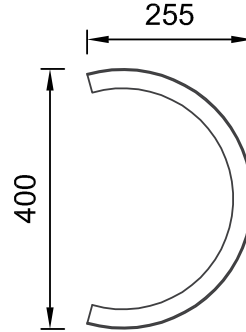

Art.Nr.: FFXBDI

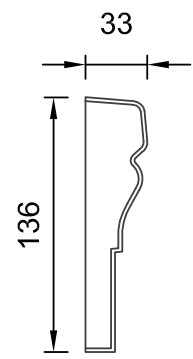

Art.Nr.: FFXBDT

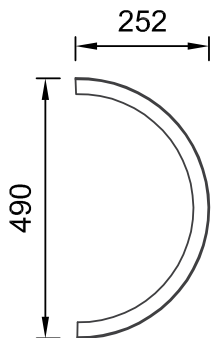

Art.Nr.: FFXBCZ

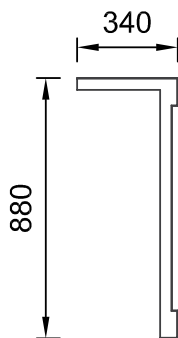

Art.Nr.: FFXBDF

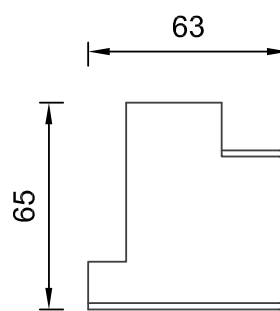

Art.Nr.: FFXBDN

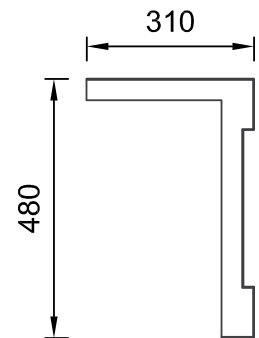

Art.Nr.: FFXBDU



QR-Code einfach scannen und
Austrotherm Materiallist-Generator
online nutzen.

Austrotherm Rahmenprofil

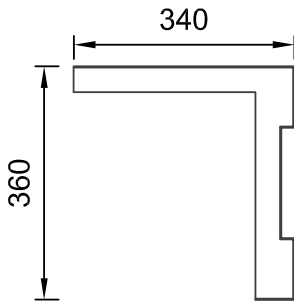

Art.Nr.: FFXBDV

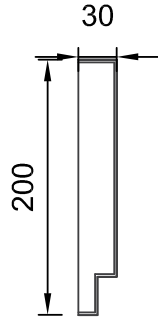

Art.Nr.: FFXBEG

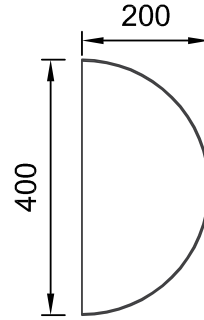

Art.Nr.: FFXBEP

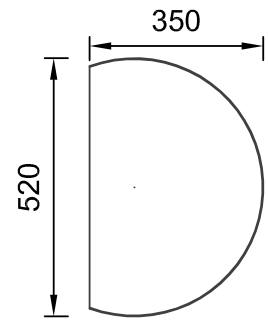

Art.Nr.: FFXBEZ

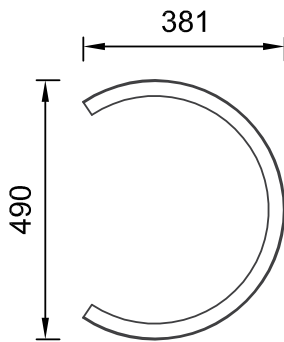

Art.Nr.: FFXBDY

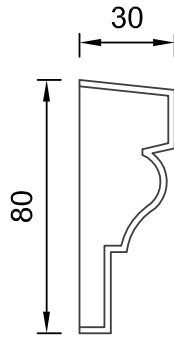

Art.Nr.: FFXBEL

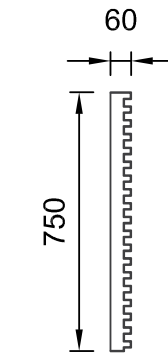

Art.Nr.: FFXBEU

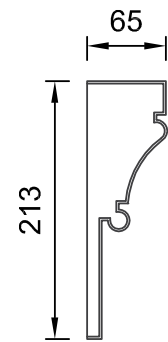

Art.Nr.: FFXBFC

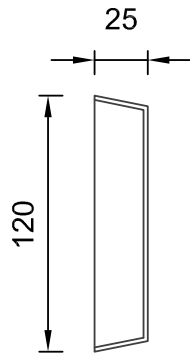

Art.Nr.: FFXBED

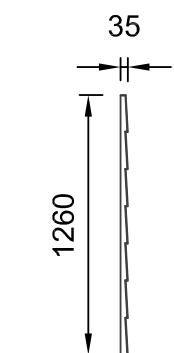

Art.Nr.: FFXBEN

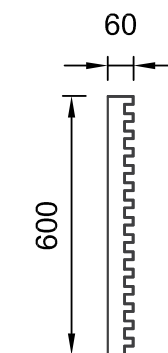

Art.Nr.: FFXBEV

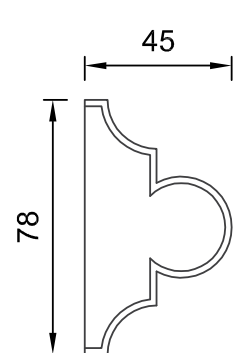

Art.Nr.: FFXBFG

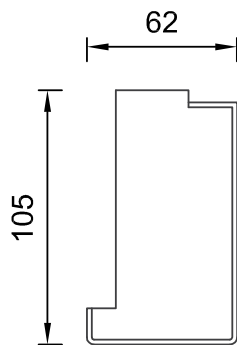

Art.Nr.: FFXBEE

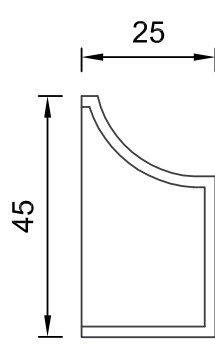

Art.Nr.: FFXBEO

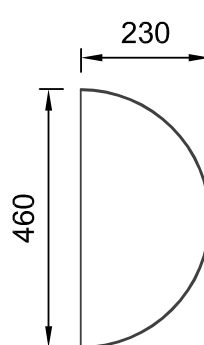

Art.Nr.: FFXBEY

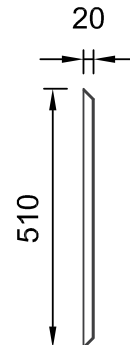

Art.Nr.: FFXBFP



QR-Code einfach scannen und
Austrotherm Materiallisten-Generator
online nutzen.

Austrotherm Rahmenprofil

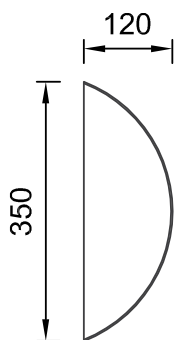

Art.Nr.: FFXBFS

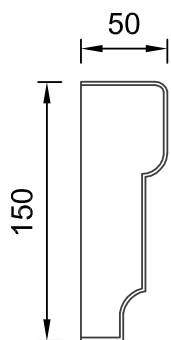

Art.Nr.: FFXBFY

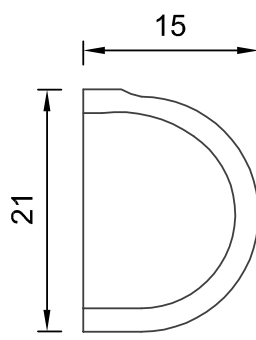

Art.Nr.: FFXBGD

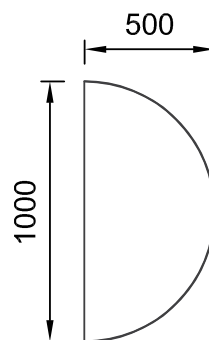

Art.Nr.: FFXBGK

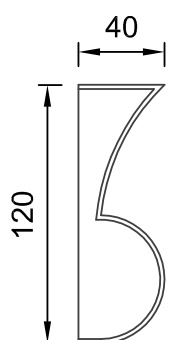

Art.Nr.: FFXBFV

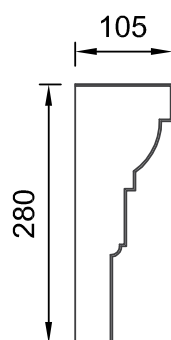

Art.Nr.: FFXBFZ

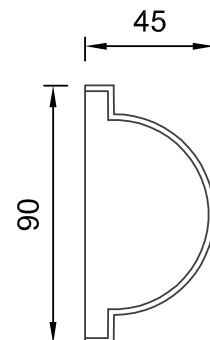

Art.Nr.: FFXBGE

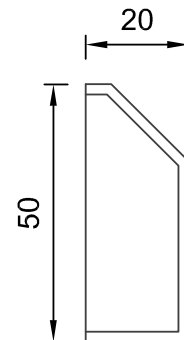

Art.Nr.: FFXBGN

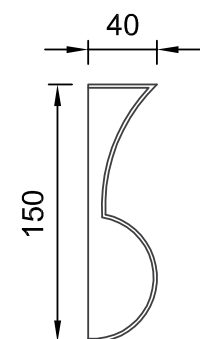

Art.Nr.: FFXBFW

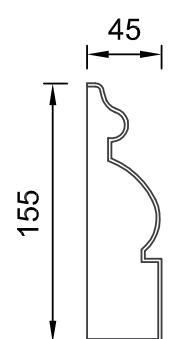

Art.Nr.: FFXBGB

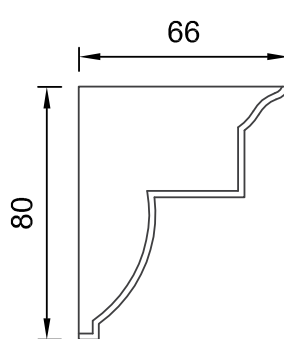

Art.Nr.: FFXBGF

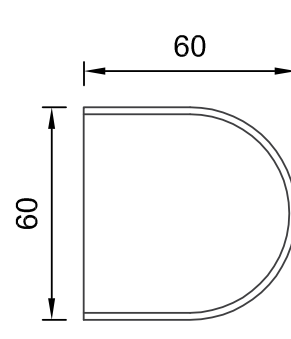

Art.Nr.: FFXBGR

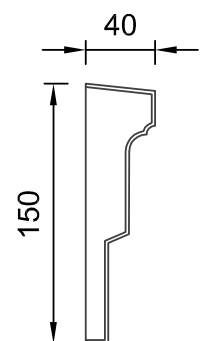

Art.Nr.: FFXBFX

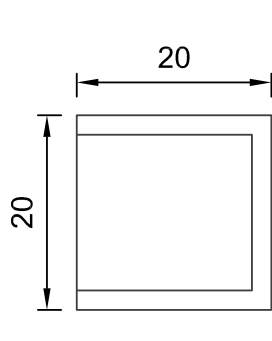

Art.Nr.: FFXBGC

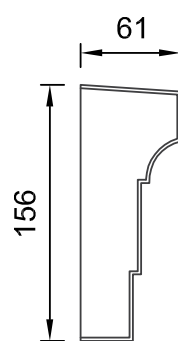

Art.Nr.: FFXBGI

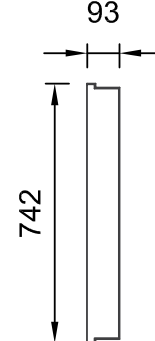

Art.Nr.: FFXBGS



QR-Code einfach scannen und
Austrotherm Materialisten-Generator
online nutzen.

Austrotherm Rahmenprofil

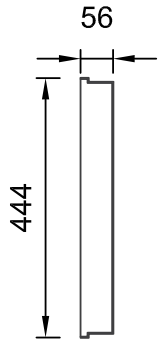

Art.Nr.: FFXBGT

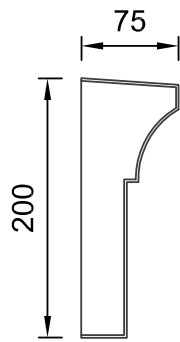

Art.Nr.: FFXBHD

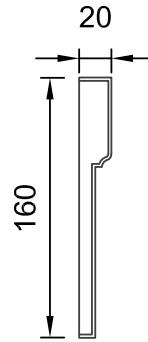

Art.Nr.: FFXBHK

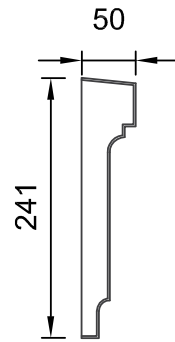

Art.Nr.: FFXBHP

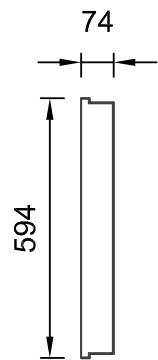

Art.Nr.: FFXBGU

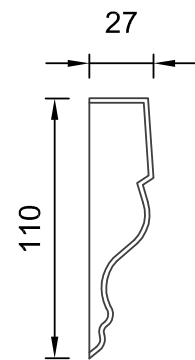

Art.Nr.: FFXBHE

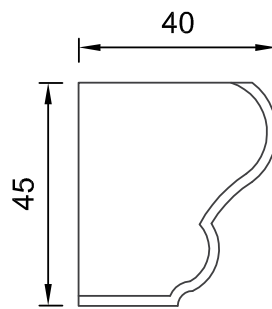

Art.Nr.: FFXBHL

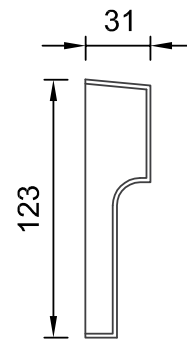

Art.Nr.: FFXBHQ

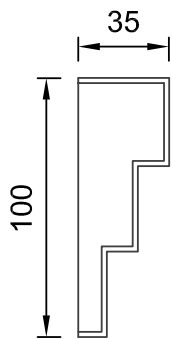

Art.Nr.: FFXBHA

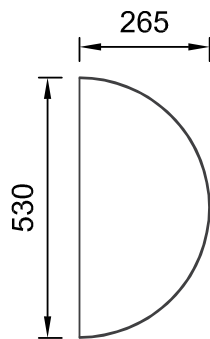

Art.Nr.: FFXBHF

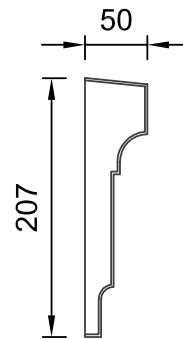

Art.Nr.: FFXBHM

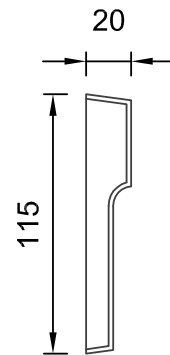

Art.Nr.: FFXBHT

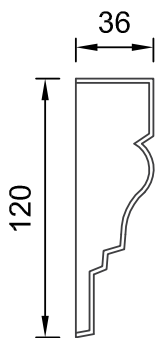

Art.Nr.: FFXBHC

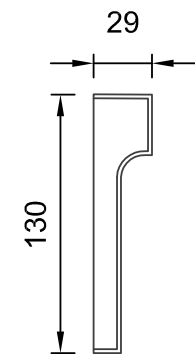

Art.Nr.: FFXBHJ

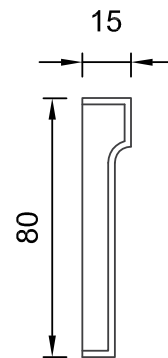

Art.Nr.: FFXBHO

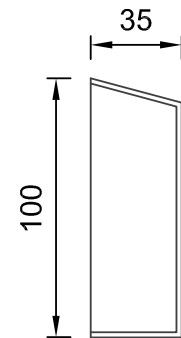

Art.Nr.: FFXBHW



QR-Code einfach scannen und
Austrotherm Materiallisten-Generator
online nutzen.

Austrotherm Rahmenprofil

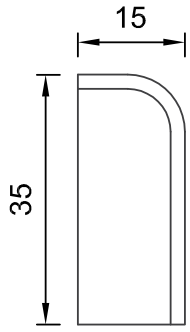

Art.Nr.: FFXBHX

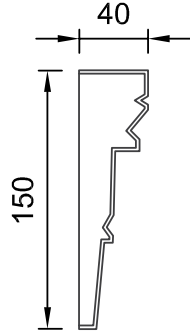

Art.Nr.: FFXBIE

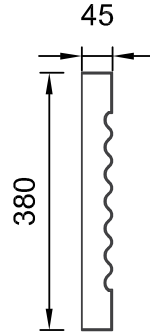

Art.Nr.: FFXBIJ

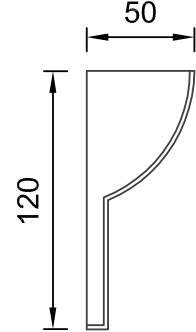

Art.Nr.: FFXBIR

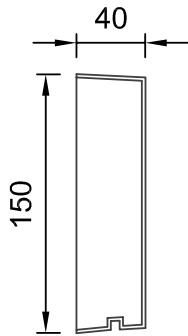

Art.Nr.: FFXBHY

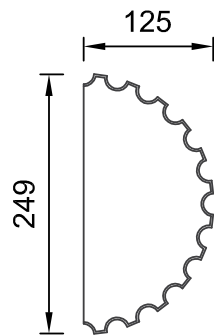

Art.Nr.: FFXBIF

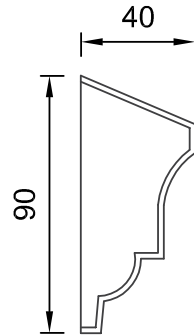

Art.Nr.: FFXBIN

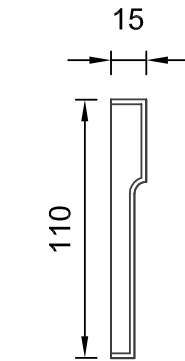

Art.Nr.: FFXBIT

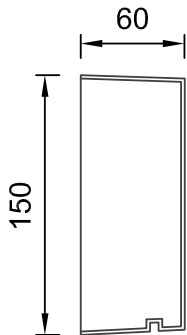

Art.Nr.: FFXBHZ

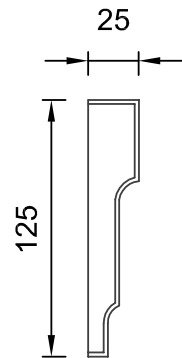

Art.Nr.: FFXBIH

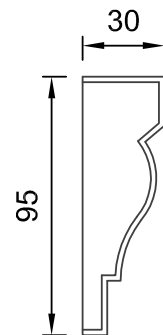

Art.Nr.: FFXBIO

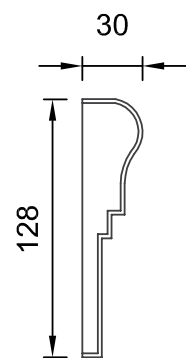

Art.Nr.: FFXBIW

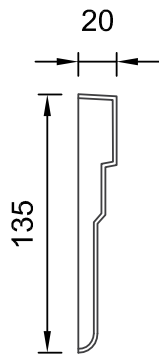

Art.Nr.: FFXBIA

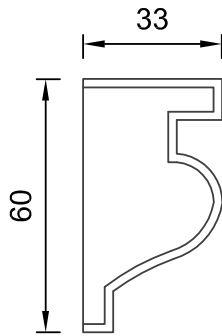

Art.Nr.: FFXBII

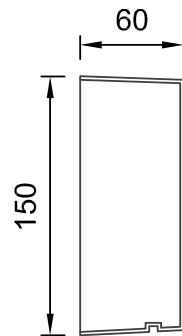

Art.Nr.: FFXBIQ

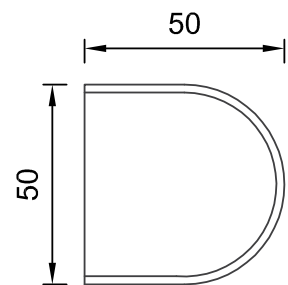

Art.Nr.: FFXBIX



QR-Code einfach scannen und
Austrotherm Materialisten-Generator
online nutzen.

Austrotherm Rahmenprofil

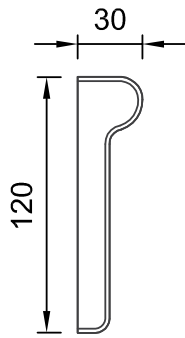

Art.Nr.: FFXBIY

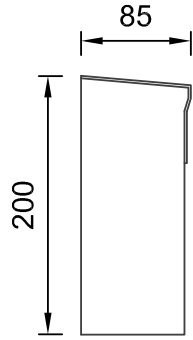

Art.Nr.: FFXBJF

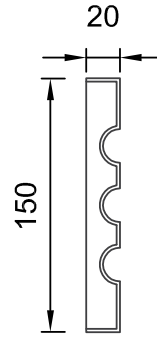

Art.Nr.: FFXBJN

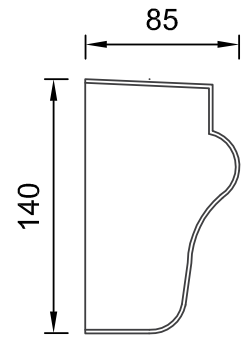

Art.Nr.: FFXBLV

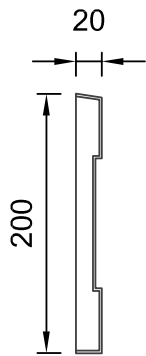

Art.Nr.: FFXBJA

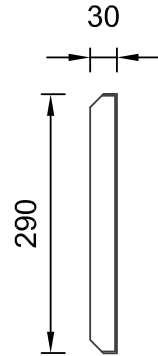

Art.Nr.: FFXBJH

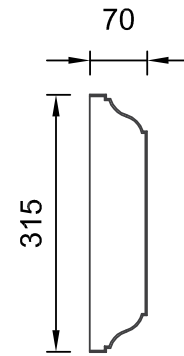

Art.Nr.: FFXBJO

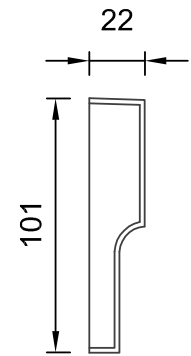

Art.Nr.: FFXBMA

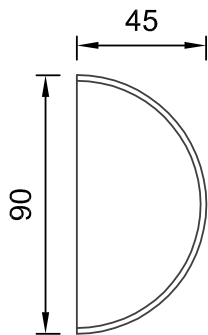

Art.Nr.: FFXBJD

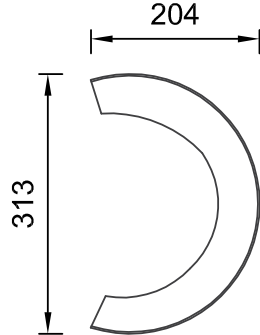

Art.Nr.: FFXBJK

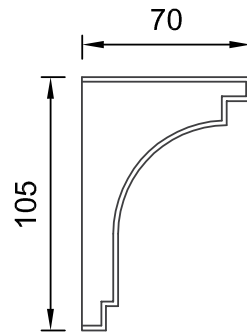

Art.Nr.: FFXBLP

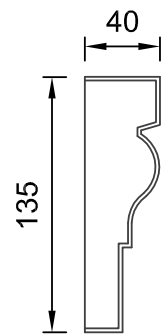

Art.Nr.: FFXBMC

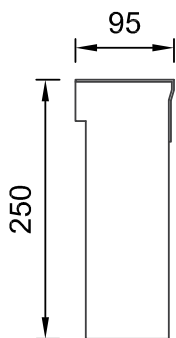

Art.Nr.: FFXBJE

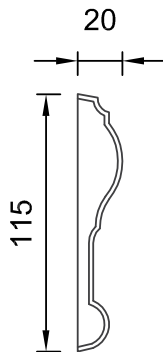

Art.Nr.: FFXBJL

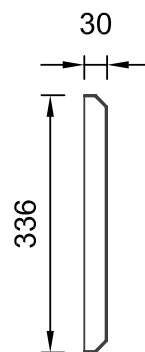

Art.Nr.: FFXBLT

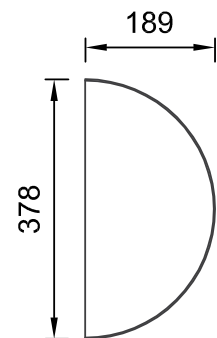

Art.Nr.: FFXBMF



QR-Code einfach scannen und
Austrotherm Materialisten-Generator
online nutzen.

Austrotherm Rahmenprofil

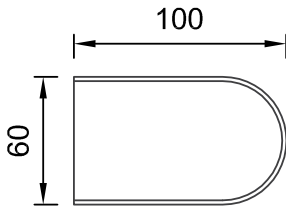

Art.Nr.: FFXBMG

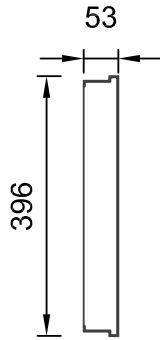

Art.Nr.: FFXBMR

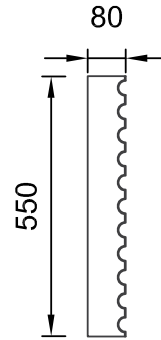

Art.Nr.: FFXBMV

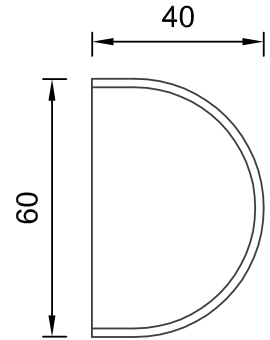

Art.Nr.: FFXBMZ

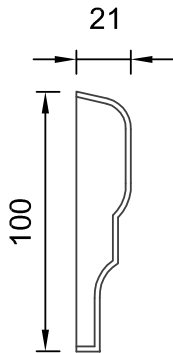

Art.Nr.: FFXBMM

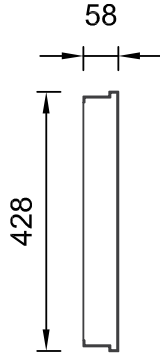

Art.Nr.: FFXBMS

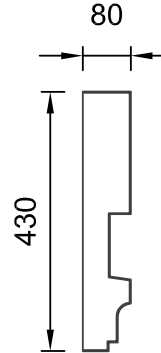

Art.Nr.: FFXBMW

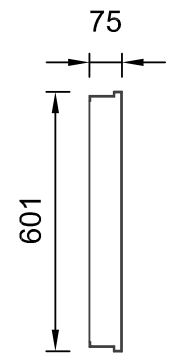

Art.Nr.: FFXBNA

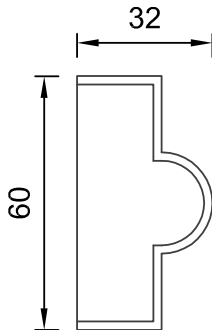

Art.Nr.: FFXBMO

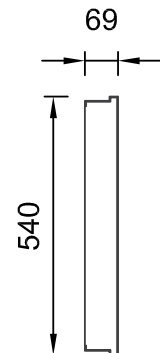

Art.Nr.: FFXBMT

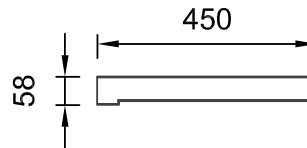

Art.Nr.: FFXBMX

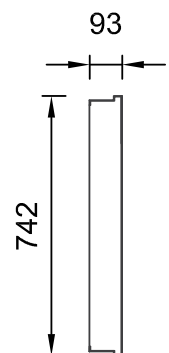

Art.Nr.: FFXBNB

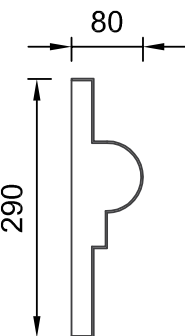

Art.Nr.: FFXBMP

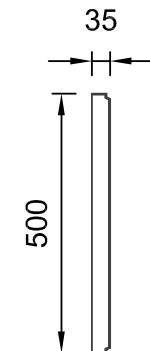

Art.Nr.: FFXBMU

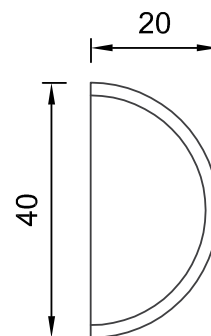

Art.Nr.: FFXBMY

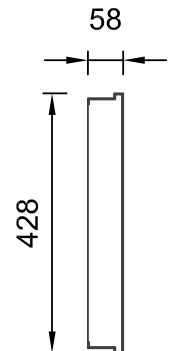

Art.Nr.: FFXBNC



QR-Code einfach scannen und
Austrotherm Materiallisten-Generator
online nutzen.

Austrotherm Rahmenprofil

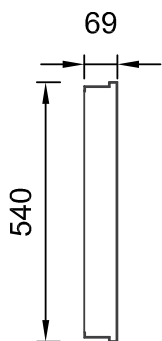

Art.Nr.: FFXBND

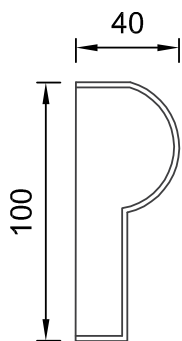

Art.Nr.: FFXBNI

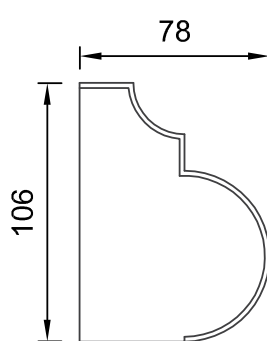

Art.Nr.: FFXBNQ

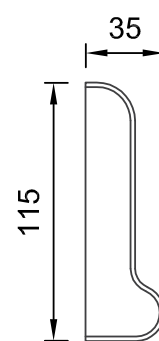

Art.Nr.: FFXBNU

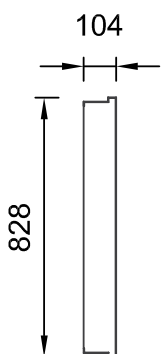

Art.Nr.: FFXBNE

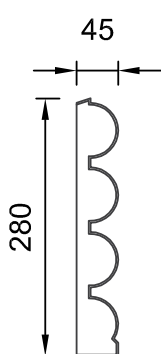

Art.Nr.: FFXBNJ

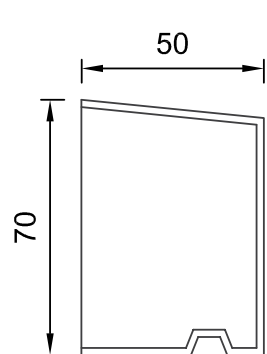

Art.Nr.: FFXBNR

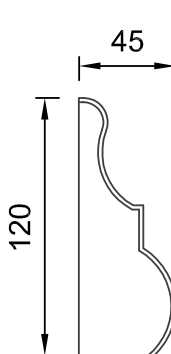

Art.Nr.: FFXBNW

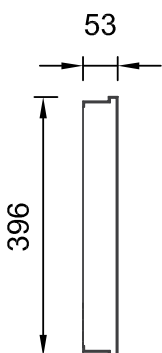

Art.Nr.: FFXBNF

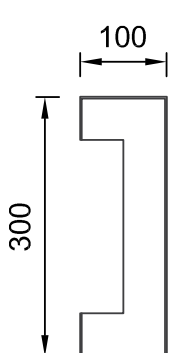

Art.Nr.: FFXBNN

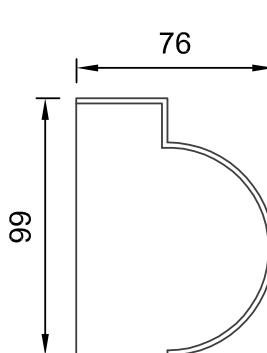

Art.Nr.: FFXBNS

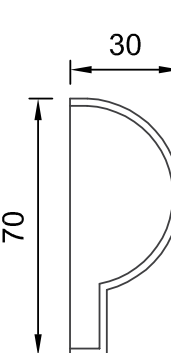

Art.Nr.: FFXBNX

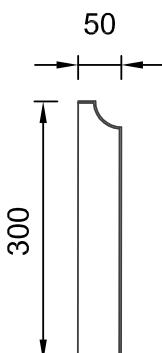

Art.Nr.: FFXBNG

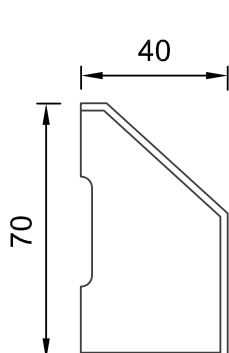

Art.Nr.: FFXBNP

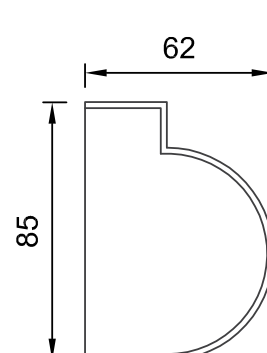

Art.Nr.: FFXBNT

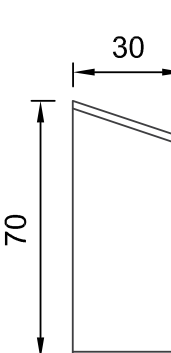

Art.Nr.: FFXBOA



QR-Code einfach scannen und
Austrotherm Materiallisten-Generator
online nutzen.

Austrotherm Rahmenprofil

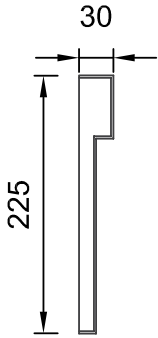

Art.Nr.: FFXBOC

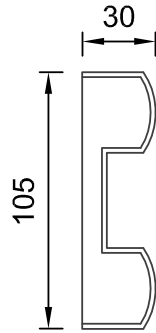

Art.Nr.: FFXBOG

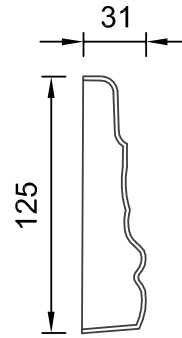

Art.Nr.: FFXBOR

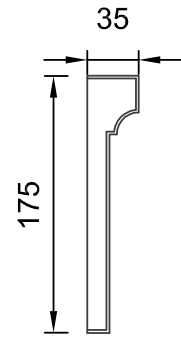

Art.Nr.: FFXBOY

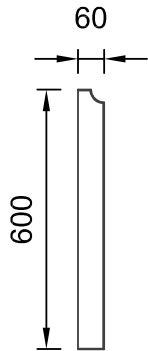

Art.Nr.: FFXBOE

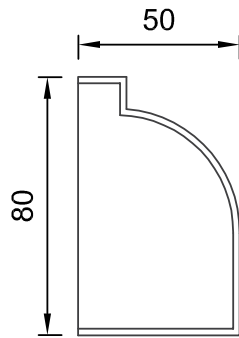

Art.Nr.: FFXBOI

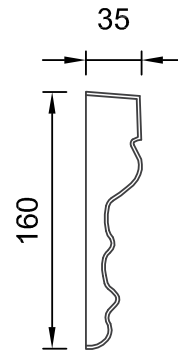

Art.Nr.: FFXBOS

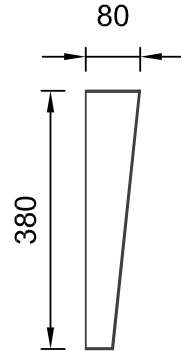

Art.Nr.: FFXBOZ

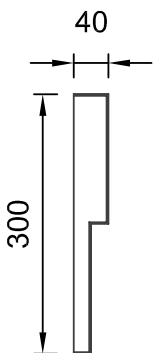

Art.Nr.: FFXBOF

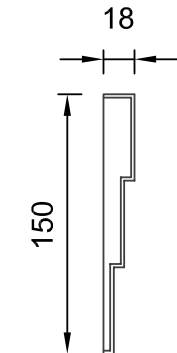

Art.Nr.: FFXBOK

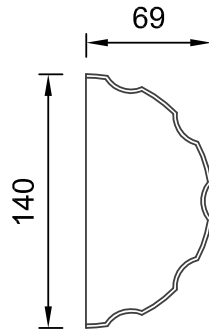

Art.Nr.: FFXBOU

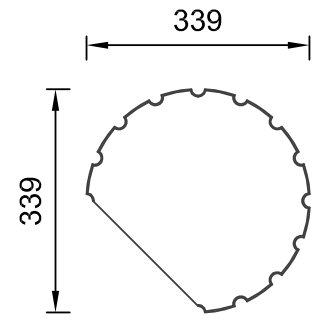

Art.Nr.: FFXBPB

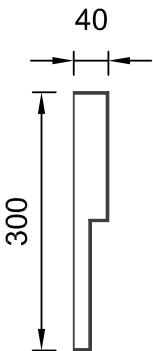

Art.Nr.: FFXBOG

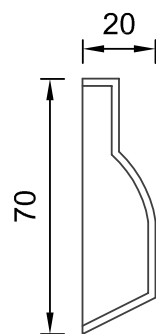

Art.Nr.: FFXBOP

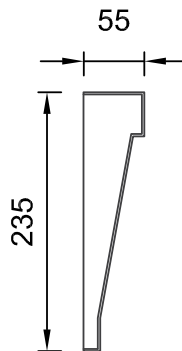

Art.Nr.: FFXBOV

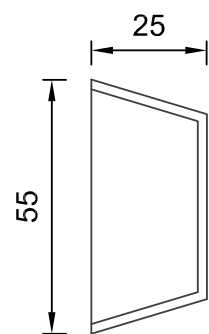

Art.Nr.: FFXBPD



QR-Code einfach scannen und
Austrotherm Materiallisten-Generator
online nutzen.

Austrotherm Rahmenprofil

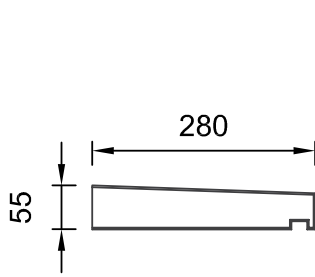

Art.Nr.: FFXBPE

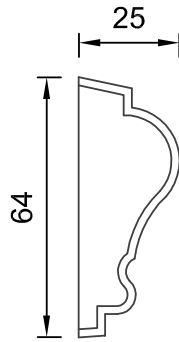

Art.Nr.: FFXBPI

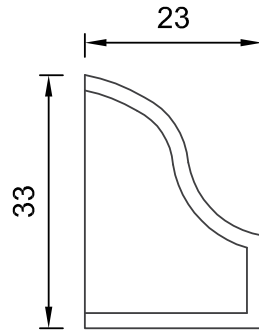

Art.Nr.: FFXBPM

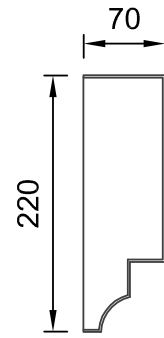

Art.Nr.: FFXBPS

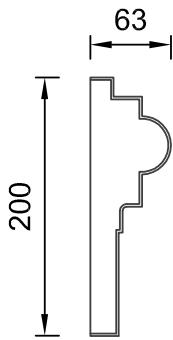

Art.Nr.: FFXBPF

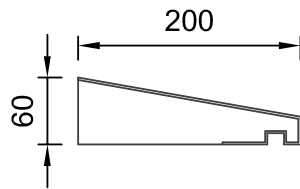

Art.Nr.: FFXBPJ



Art.Nr.: FFXBPN

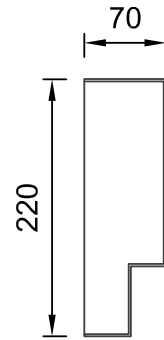

Art.Nr.: FFXBPT

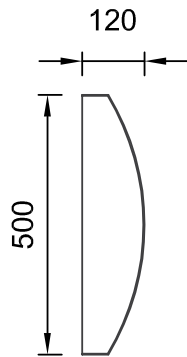

Art.Nr.: FFXBPG

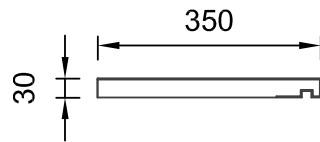

Art.Nr.: FFXBPK

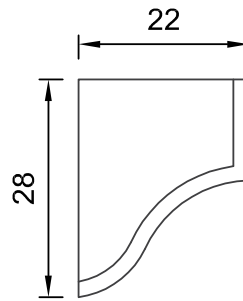

Art.Nr.: FFXBPO

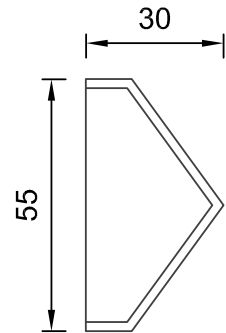

Art.Nr.: FFXBPX

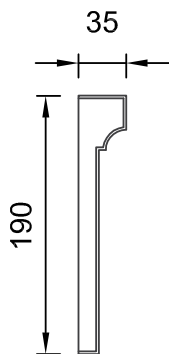

Art.Nr.: FFXBPH

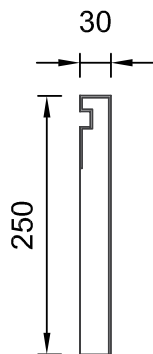

Art.Nr.: FFXBPL

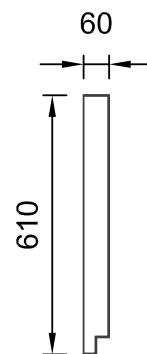

Art.Nr.: FFXBPR

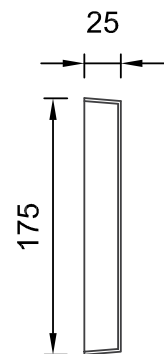

Art.Nr.: FFXBPY



QR-Code einfach scannen und
Austrotherm Materiallist-Generator
online nutzen.

Austrotherm Rahmenprofil

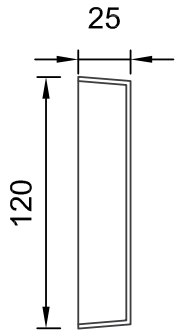

Art.Nr.: FFXBPZ

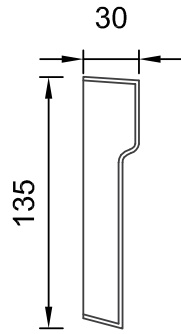

Art.Nr.: FFXBQH

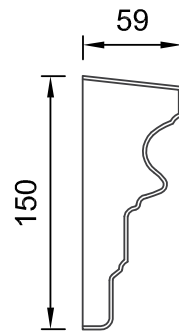

Art.Nr.: FFXBQM

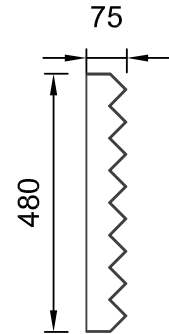

Art.Nr.: FFXBQT

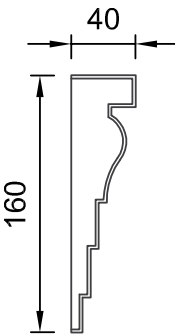

Art.Nr.: FFXBQA

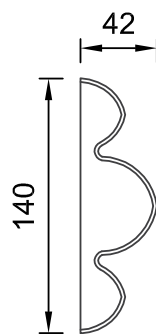

Art.Nr.: FFXBQI

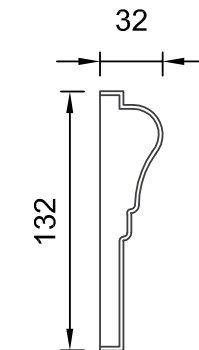

Art.Nr.: FFXBQN

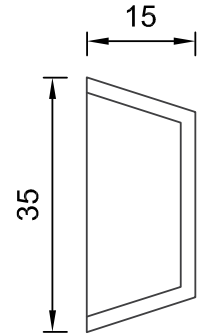

Art.Nr.: FFXBQU

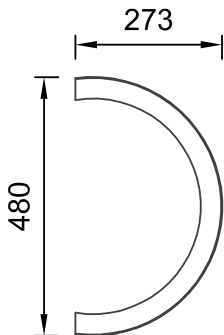

Art.Nr.: FFXBQB

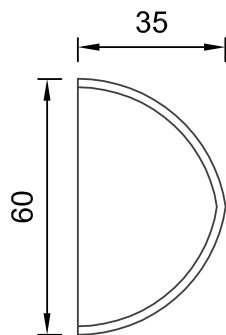

Art.Nr.: FFXBQJ

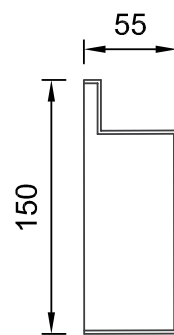

Art.Nr.: FFXBQO

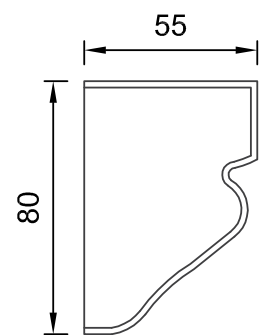

Art.Nr.: FFXBQV

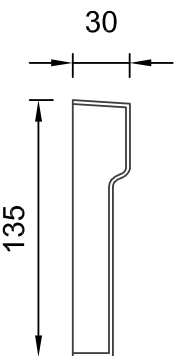

Art.Nr.: FFXBQG

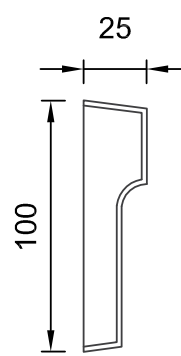

Art.Nr.: FFXBQK

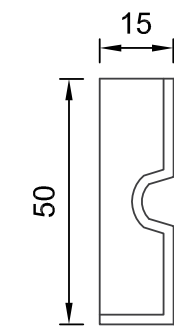

Art.Nr.: FFXBQP

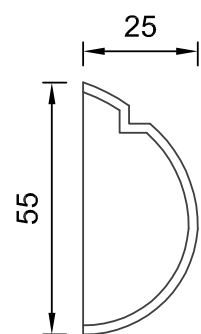

Art.Nr.: FFXBQW



QR-Code einfach scannen und
Austrotherm Materiallisten-Generator
online nutzen.

Austrotherm Rahmenprofil

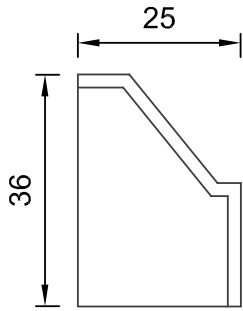

Art.Nr.: FFXBQX

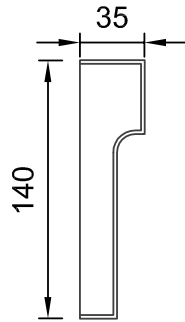

Art.Nr.: FFXBRD

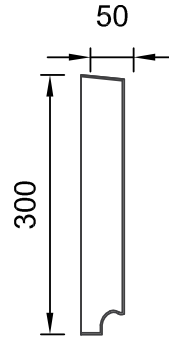

Art.Nr.: FFXBRJ

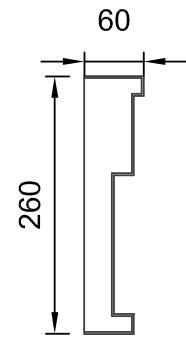

Art.Nr.: FFXBRQ

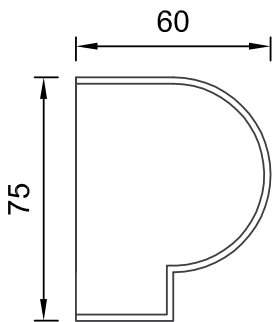

Art.Nr.: FFXBQZ

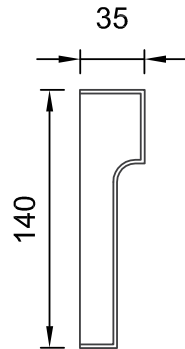

Art.Nr.: FFXBRD

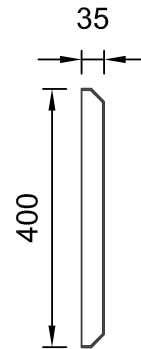

Art.Nr.: FFXBRK

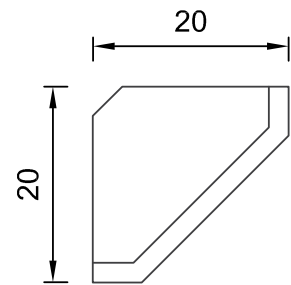

Art.Nr.: FFXBRT

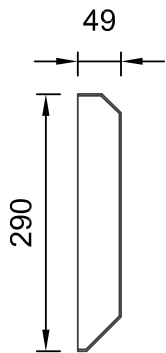

Art.Nr.: FFXBRB

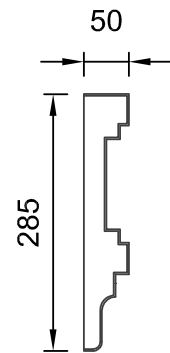

Art.Nr.: FFXBRG

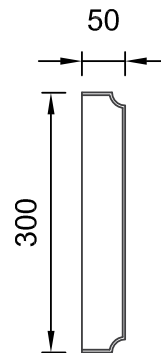

Art.Nr.: FFXBRN

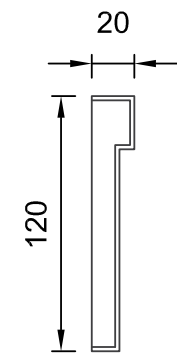

Art.Nr.: FFXBRU

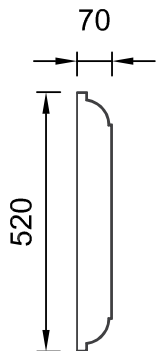

Art.Nr.: FFXBRC

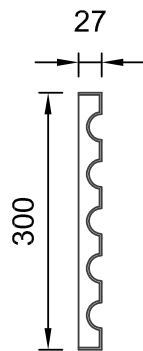

Art.Nr.: FFXBRI

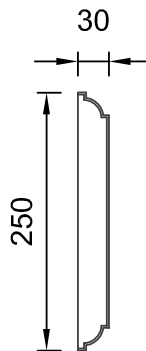

Art.Nr.: FFXBRO

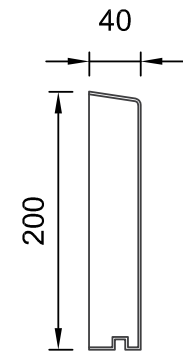

Art.Nr.: FFXBRX



QR-Code einfach scannen und
Austrotherm Materiallisten-Generator
online nutzen.

Austrotherm Rahmenprofil

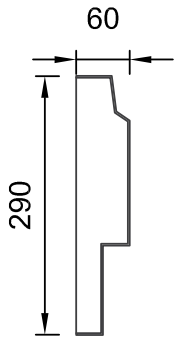

Art.Nr.: FFXBRY

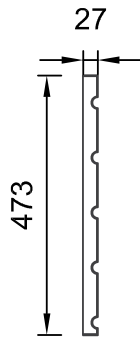

Art.Nr.: FFXBSD

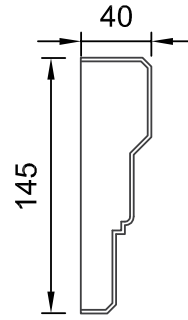

Art.Nr.: FFXBSK

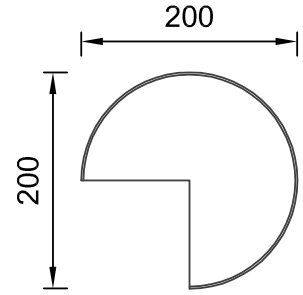

Art.Nr.: FFXBSS

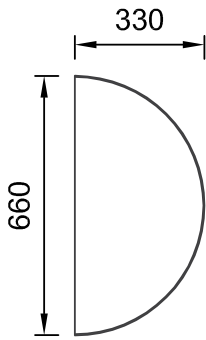

Art.Nr.: FFXBRZ

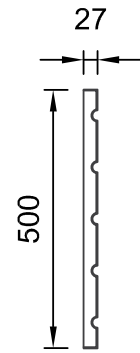

Art.Nr.: FFXBSE

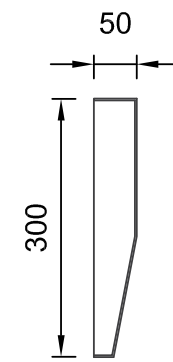

Art.Nr.: FFXBSO

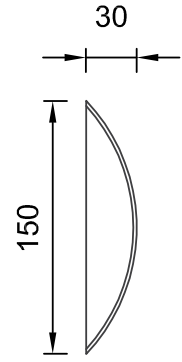

Art.Nr.: FFXBST

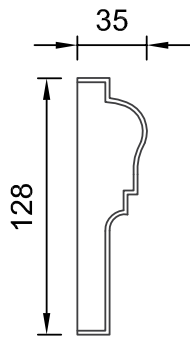

Art.Nr.: FFXBSB

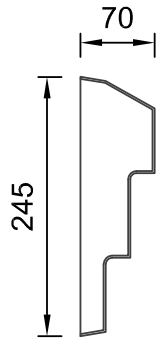

Art.Nr.: FFXBSF

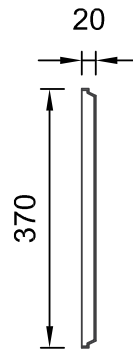

Art.Nr.: FFXBSP

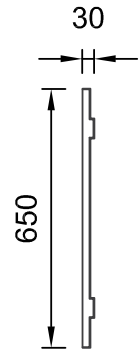

Art.Nr.: FFXBSV

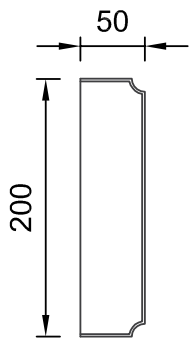

Art.Nr.: FFXBSC

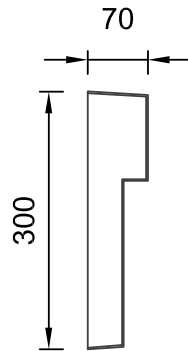

Art.Nr.: FFXBSG

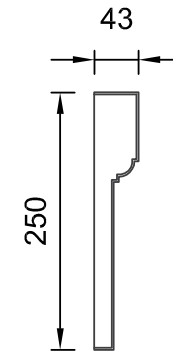

Art.Nr.: FFXBSQ

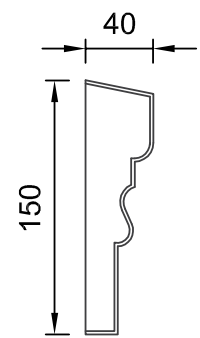

Art.Nr.: FFXBVU



QR-Code einfach scannen und
Austrotherm Materiallisten-Generator
online nutzen.

Austrotherm Rahmenprofil

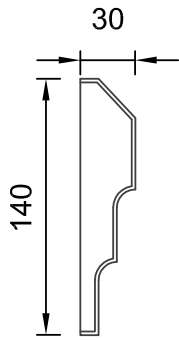

Art.Nr.: FFXBVV

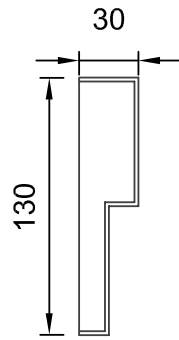

Art.Nr.: FFXBWM

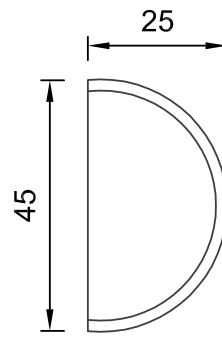

Art.Nr.: FFXBWT

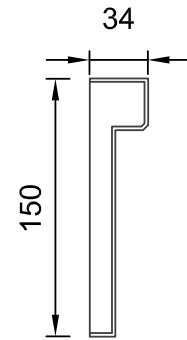

Art.Nr.: FFXBXE

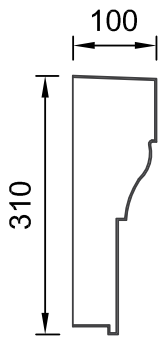

Art.Nr.: FFXBWC

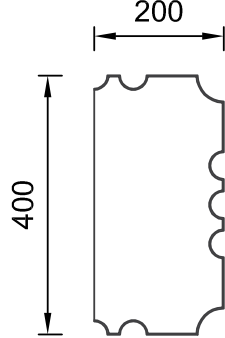

Art.Nr.: FFXBWN

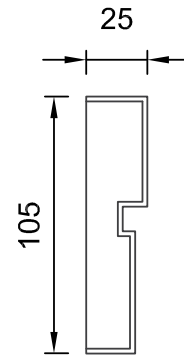

Art.Nr.: FFXBWZ

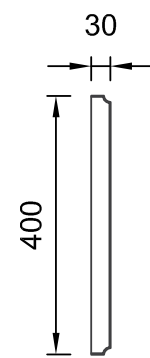

Art.Nr.: FFXBXF

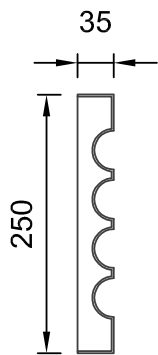

Art.Nr.: FFXBWD

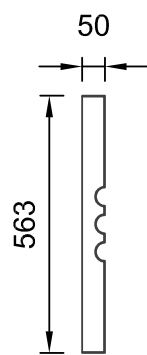

Art.Nr.: FFXBWQ

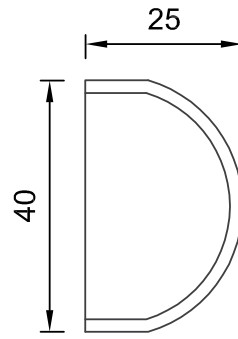

Art.Nr.: FFXBXC

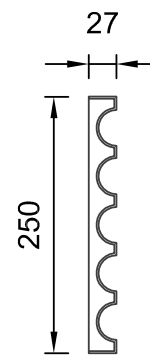

Art.Nr.: FFXBXH

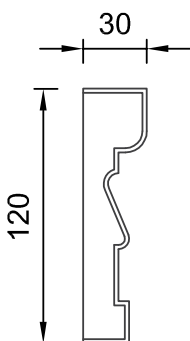

Art.Nr.: FFXBWI

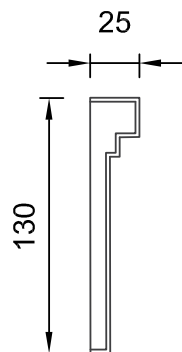

Art.Nr.: FFXBWR

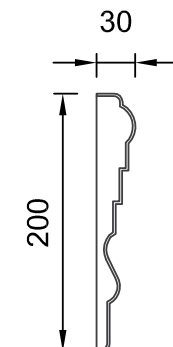

Art.Nr.: FFXBXD

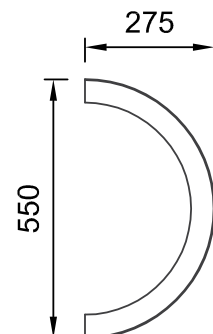

Art.Nr.: FFXBXL



QR-Code einfach scannen und
Austrotherm Materiallisten-Generator
online nutzen.

Austrotherm Rahmenprofil

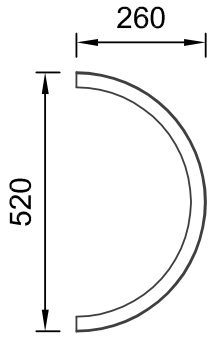

Art.Nr.: FFXBXM

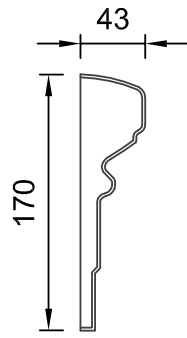

Art.Nr.: FFXBXT

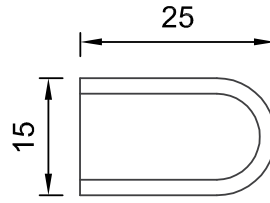

Art.Nr.: FFXBYC

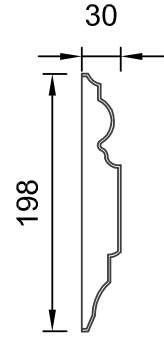

Art.Nr.: FFXBYH

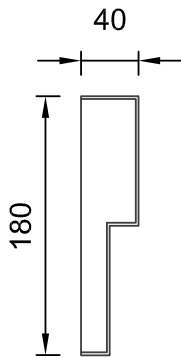

Art.Nr.: FFXBXP

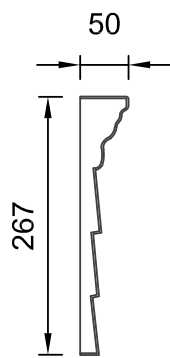

Art.Nr.: FFXBXU

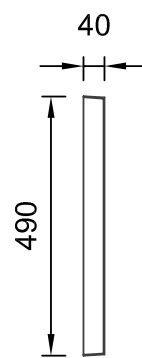

Art.Nr.: FFXBYD

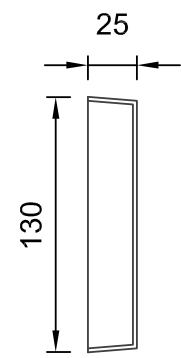

Art.Nr.: FFXBYI

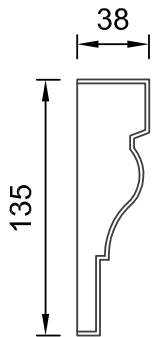

Art.Nr.: FFXBXR

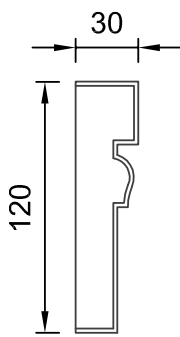

Art.Nr.: FFXBYA

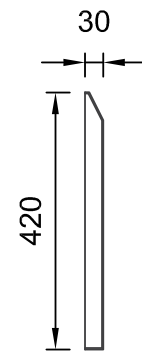

Art.Nr.: FFXBYE

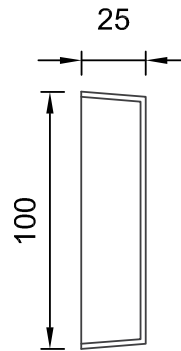

Art.Nr.: FFXBYJ

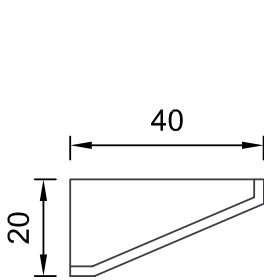

Art.Nr.: FFXBXS

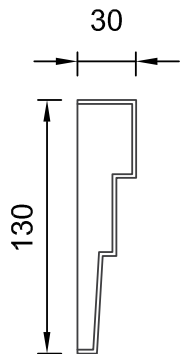

Art.Nr.: FFXBYB

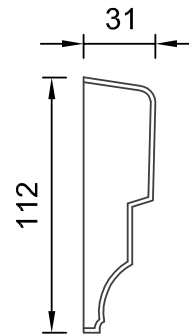

Art.Nr.: FFXBYG

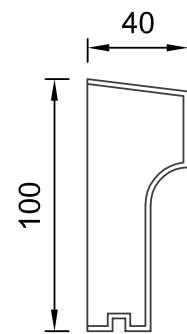

Art.Nr.: FFXBYK



QR-Code einfach scannen und
Austrotherm Materiallist-Generator
online nutzen.

Austrotherm Rahmenprofil

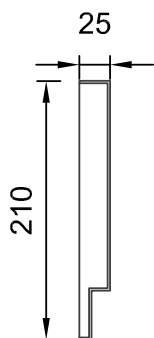

Art.Nr.: FFXBYL

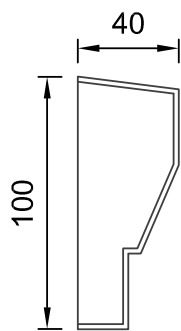

Art.Nr.: FFXBYP

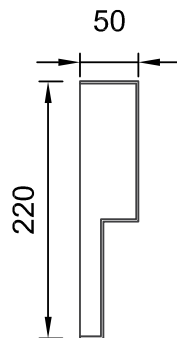

Art.Nr.: FFXBYT

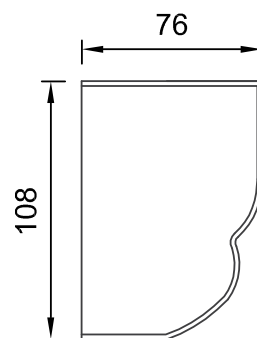

Art.Nr.: FFXBZA

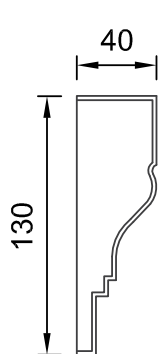

Art.Nr.: FFXBYM

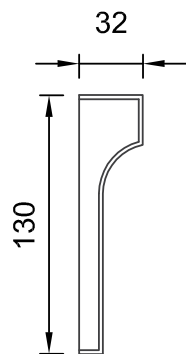

Art.Nr.: FFXBYQ

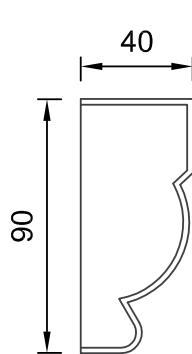

Art.Nr.: FFXBYX

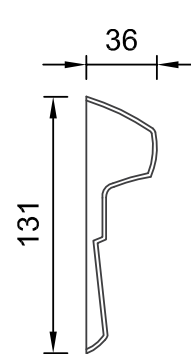

Art.Nr.: FFXBZB

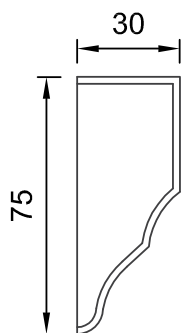

Art.Nr.: FFXBYN

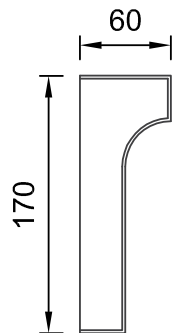

Art.Nr.: FFXBYR

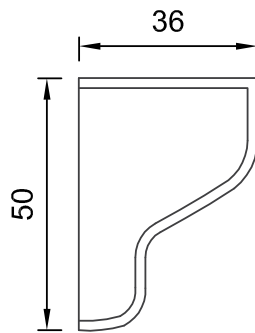

Art.Nr.: FFXBYY

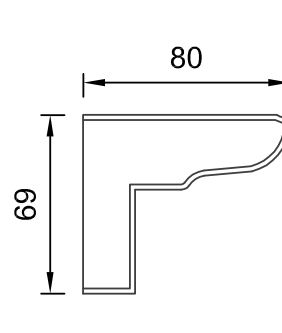

Art.Nr.: FFXBZC

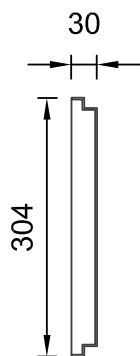

Art.Nr.: FFXBYO

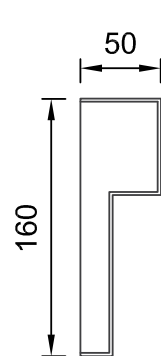

Art.Nr.: FFXBYS

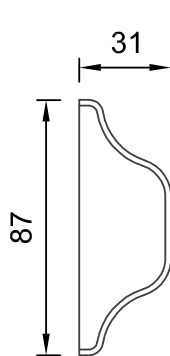

Art.Nr.: FFXBYZ

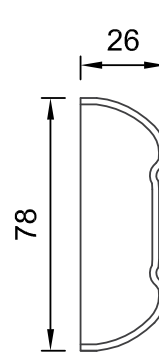

Art.Nr.: FFXBZD



QR-Code einfach scannen und
Austrotherm Materiallisten-Generator
online nutzen.

Austrotherm Rahmenprofil

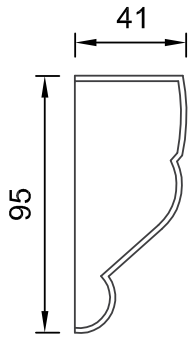

Art.Nr.: FFXBZE

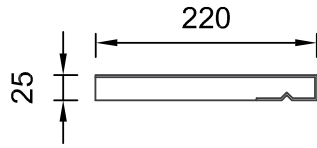

Art.Nr.: FFXBZI

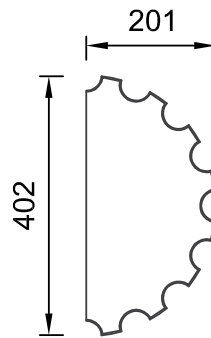

Art.Nr.: FFXBZM

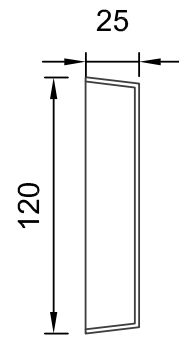

Art.Nr.: FFXBZR

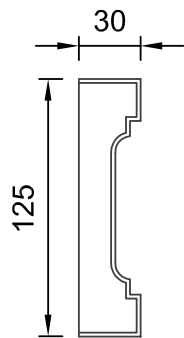

Art.Nr.: FFXBZF

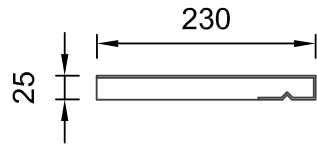

Art.Nr.: FFXBZJ

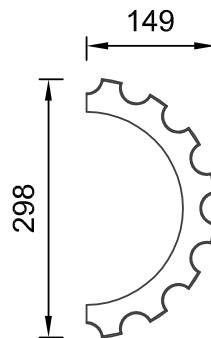

Art.Nr.: FFXBZO

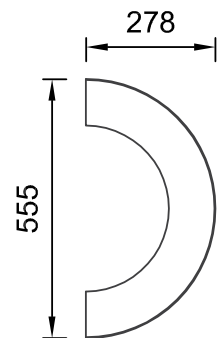

Art.Nr.: FFXBZS

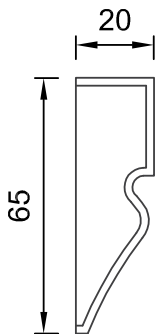

Art.Nr.: FFXBZG

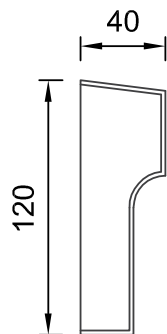

Art.Nr.: FFXBZK

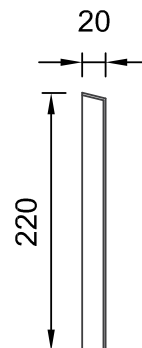

Art.Nr.: FFXBZP

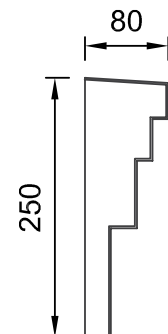

Art.Nr.: FFXBZT

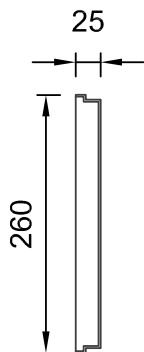

Art.Nr.: FFXBZH

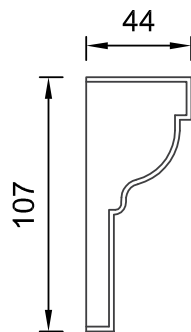

Art.Nr.: FFXBZL

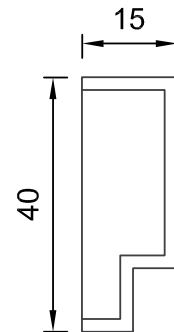

Art.Nr.: FFXBZQ

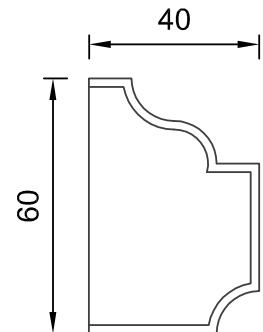

Art.Nr.: FFXBZU



QR-Code einfach scannen und
Austrotherm Materialisten-Generator
online nutzen.

Austrotherm Rahmenprofil

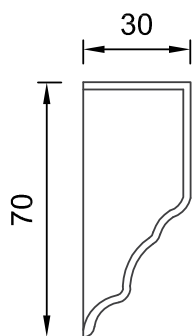

Art.Nr.: FFXBZV

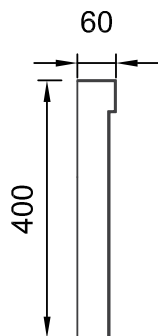

Art.Nr.: FFXCAA

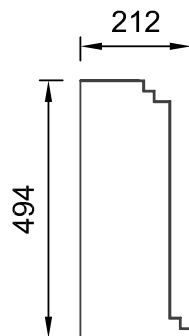

Art.Nr.: FFXCAE

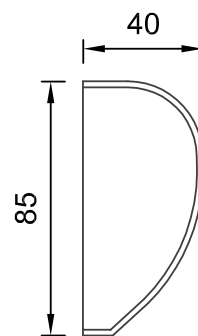

Art.Nr.: FFXCAI

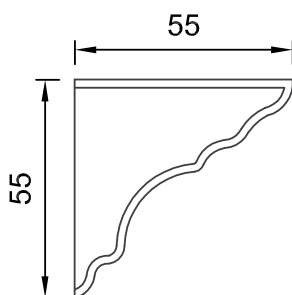

Art.Nr.: FFXBZW

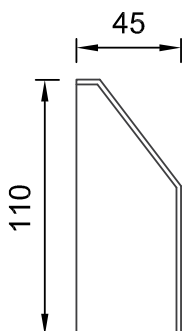

Art.Nr.: FFXCAB

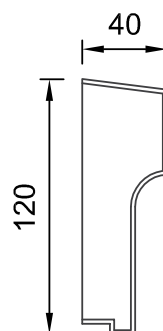

Art.Nr.: FFXCAF

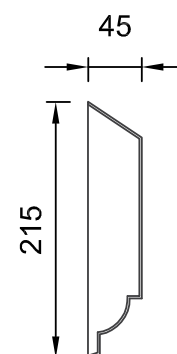

Art.Nr.: FFXCAJ

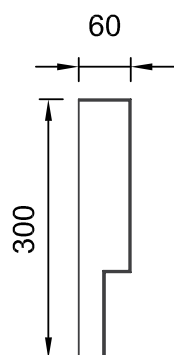

Art.Nr.: FFXBZX

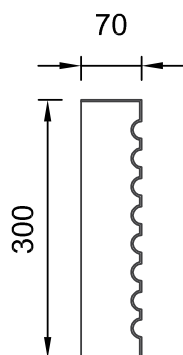

Art.Nr.: FFXCAC

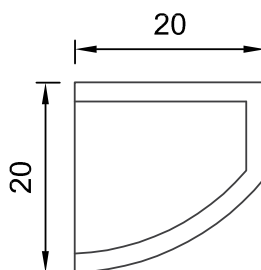

Art.Nr.: FFXCAG

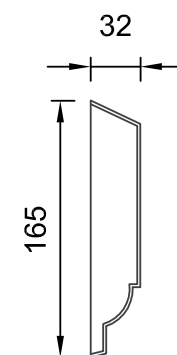

Art.Nr.: FFXCAK

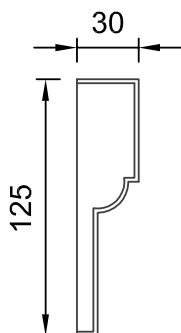

Art.Nr.: FFXBZZ

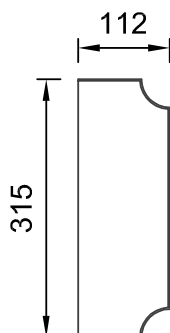

Art.Nr.: FFXCAD

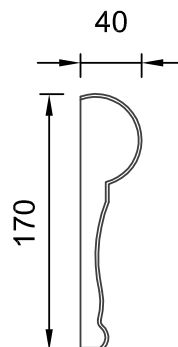

Art.Nr.: FFXCAH

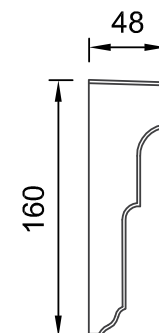

Art.Nr.: FFXCAL



QR-Code einfach scannen und
Austrotherm Materialisten-Generator
online nutzen.

Austrotherm Rahmenprofil

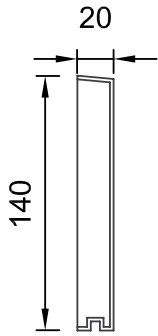

Art.Nr.: FFXCAM

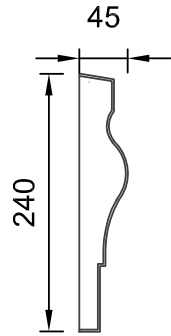

Art.Nr.: FFXCAQ

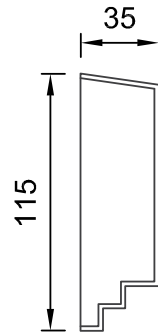

Art.Nr.: FFXCAU

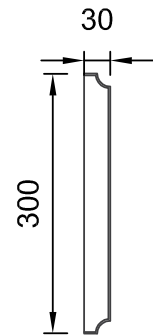

Art.Nr.: FFXCAZ

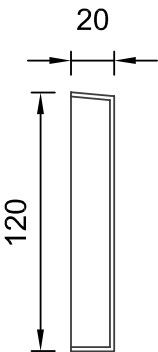

Art.Nr.: FFXCAN

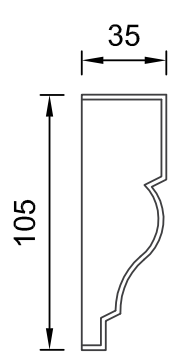

Art.Nr.: FFXCAR

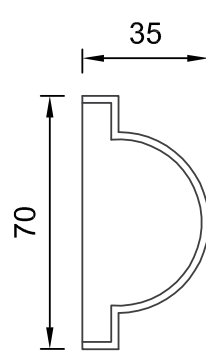

Art.Nr.: FFXCAV

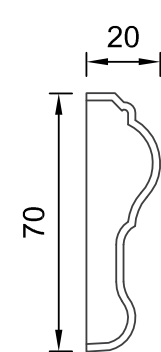

Art.Nr.: FFXCBC

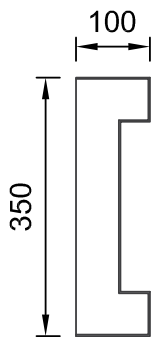

Art.Nr.: FFXCAO

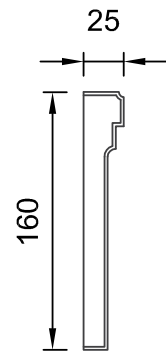

Art.Nr.: FFXCAS

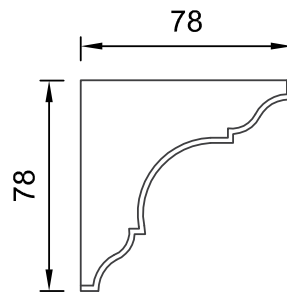

Art.Nr.: FFXCAW

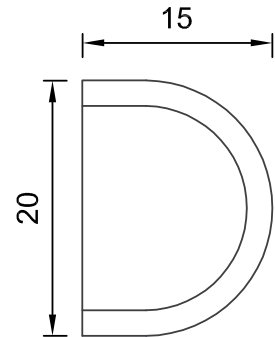

Art.Nr.: FFXCBD

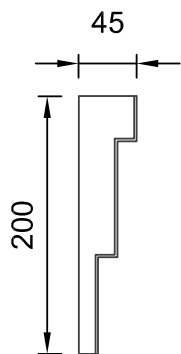

Art.Nr.: FFXCAP

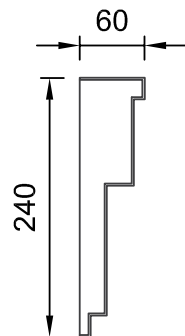

Art.Nr.: FFXCAT

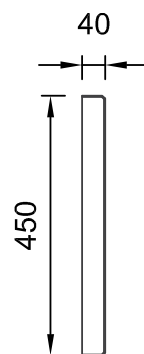

Art.Nr.: FFXCAX

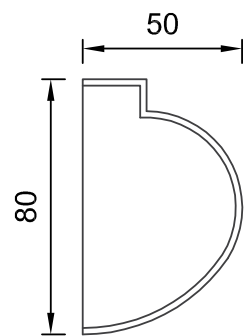

Art.Nr.: FFXCBE



QR-Code einfach scannen und
Austrotherm Materiallisten-Generator
online nutzen.

Austrotherm Rahmenprofil

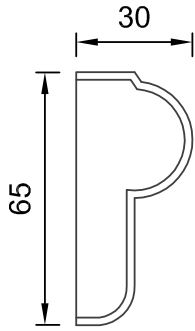

Art.Nr.: FFXCBF

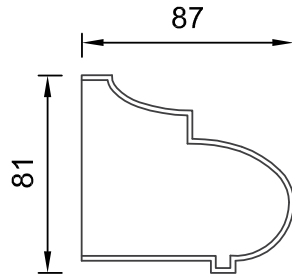

Art.Nr.: FFXCBJ

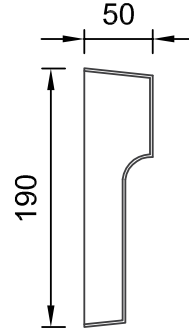

Art.Nr.: FFXCBN

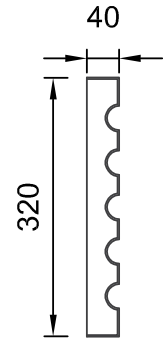

Art.Nr.: FFXCBR

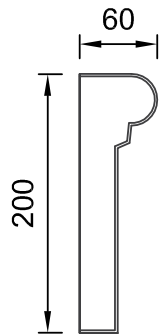

Art.Nr.: FFXCBG

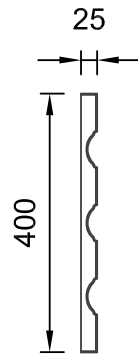

Art.Nr.: FFXCBK

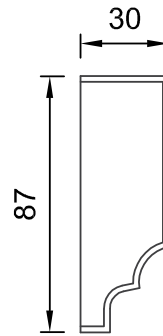

Art.Nr.: FFXCBO

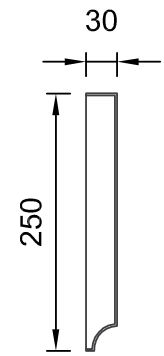

Art.Nr.: FFXCBS

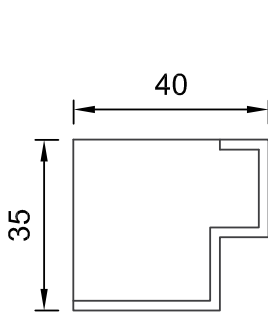

Art.Nr.: FFXCBH

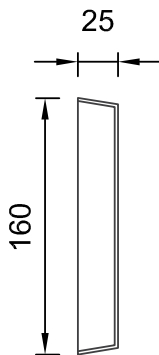

Art.Nr.: FFXCBL

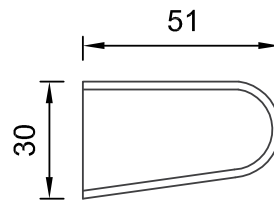

Art.Nr.: FFXCBP

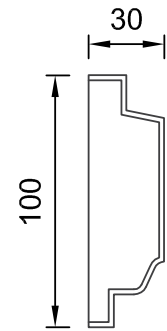

Art.Nr.: FFXCBT

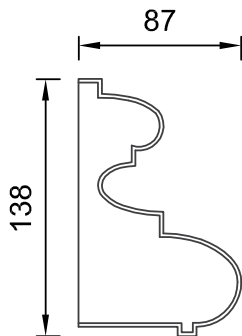

Art.Nr.: FFXCBI

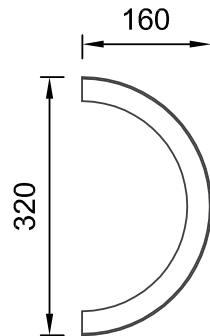

Art.Nr.: FFXCBM

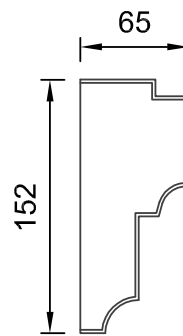

Art.Nr.: FFXCBQ

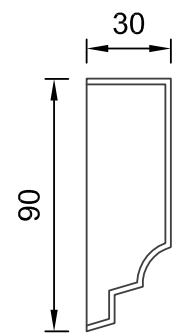

Art.Nr.: FFXCBU



QR-Code einfach scannen und
Austrotherm Materialisten-Generator
online nutzen.

Austrotherm Rahmenprofil

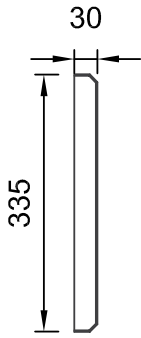

Art.Nr.: FFXCBV

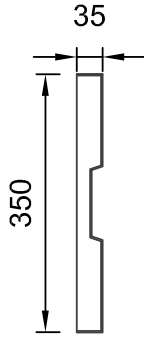

Art.Nr.: FFXCCA

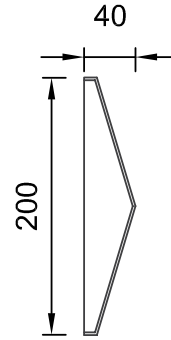

Art.Nr.: FFXCCF

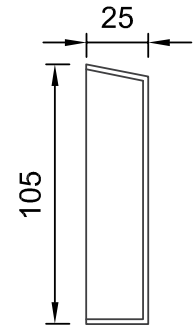

Art.Nr.: FFXCCJ

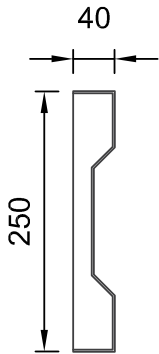

Art.Nr.: FFXCBX

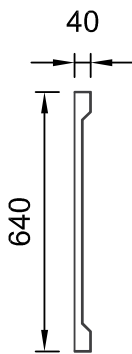

Art.Nr.: FFXCCB

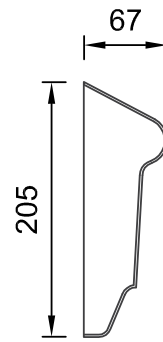

Art.Nr.: FFXCCG

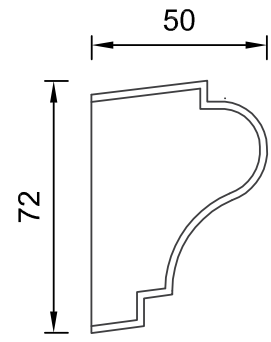

Art.Nr.: FFXCCK

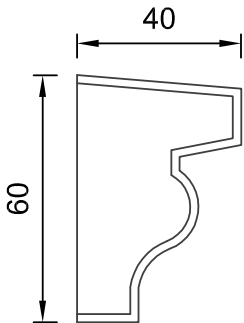

Art.Nr.: FFXCBY

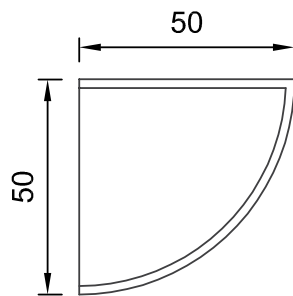

Art.Nr.: FFXCCC

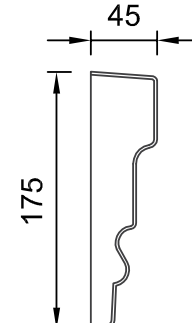

Art.Nr.: FFXCCH

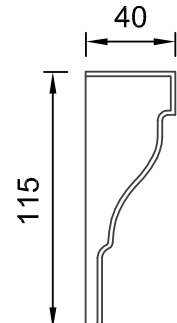

Art.Nr.: FFXCCL

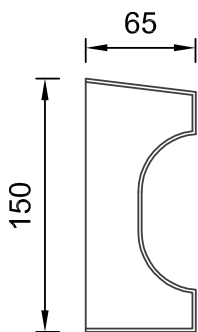

Art.Nr.: FFXCBZ

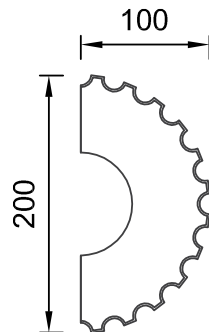

Art.Nr.: FFXCCE

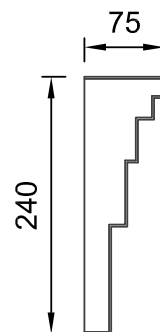

Art.Nr.: FFXCCI

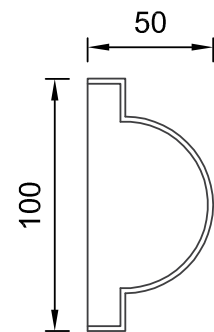

Art.Nr.: FFXCCM



QR-Code einfach scannen und
Austrotherm Materialisten-Generator
online nutzen.

Austrotherm Rahmenprofil

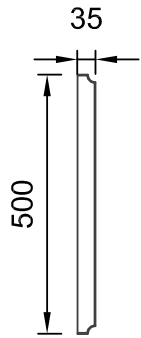

Art.Nr.: FFXCCN

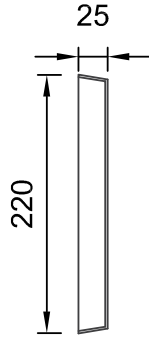

Art.Nr.: FFXCCR

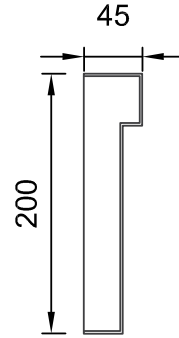

Art.Nr.: FFXCCV

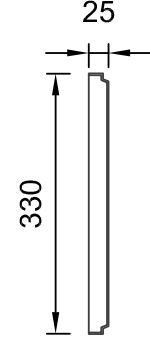

Art.Nr.: FFXCCZ

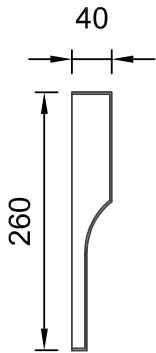

Art.Nr.: FFXCCO

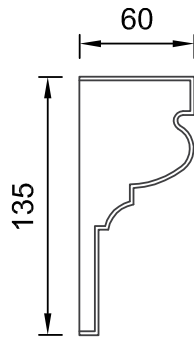

Art.Nr.: FFXCCS

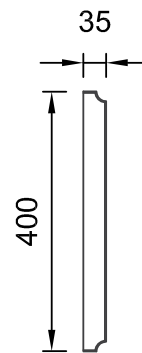

Art.Nr.: FFXCCW

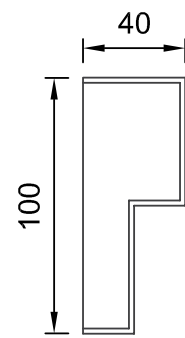

Art.Nr.: FFXCDA

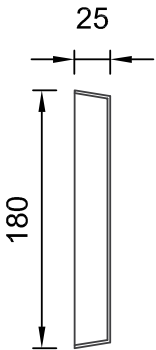

Art.Nr.: FFXCCP

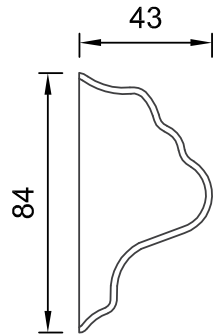

Art.Nr.: FFXCCT

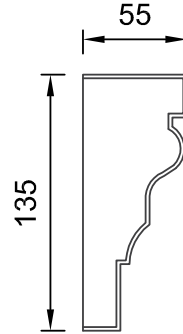

Art.Nr.: FFXCCX

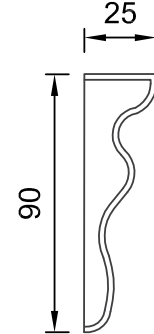

Art.Nr.: FFXCDB

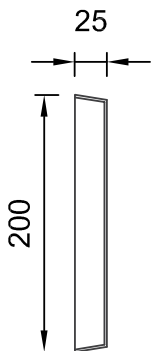

Art.Nr.: FFXCCQ

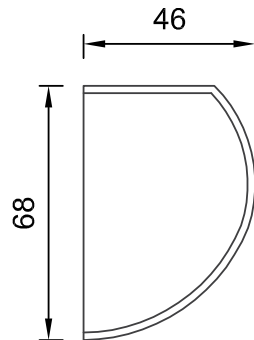

Art.Nr.: FFXCCU

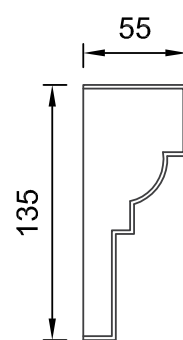

Art.Nr.: FFXCCY

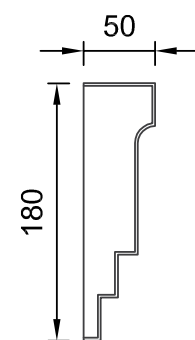

Art.Nr.: FFXCDC



QR-Code einfach scannen und
Austrotherm Materiallisten-Generator
online nutzen.

Austrotherm Rahmenprofil

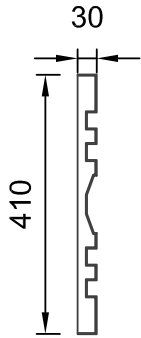

Art.Nr.: FFXCDD

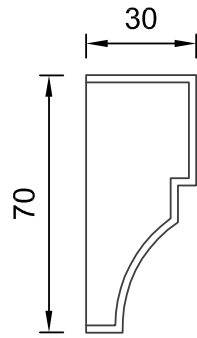

Art.Nr.: FFXCDH

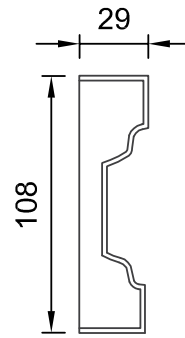

Art.Nr.: FFXCDL

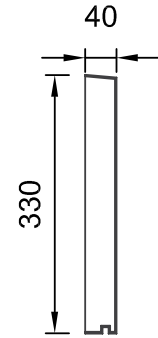

Art.Nr.: FFXCDQ

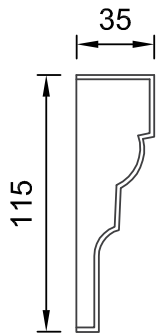

Art.Nr.: FFXCDE

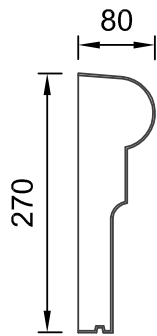

Art.Nr.: FFXCDI

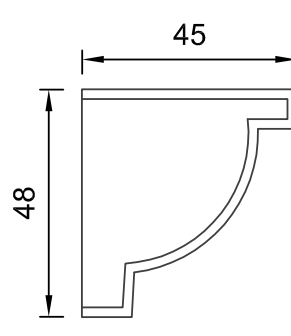

Art.Nr.: FFXCDM

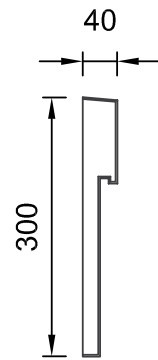

Art.Nr.: FFXCDR

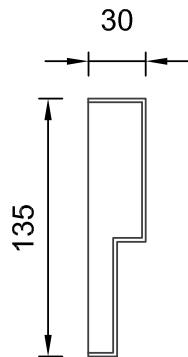

Art.Nr.: FFXCDF

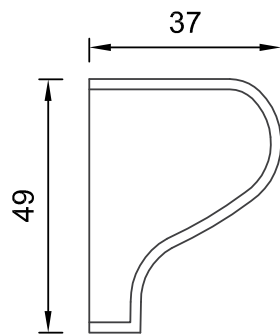

Art.Nr.: FFXCDJ

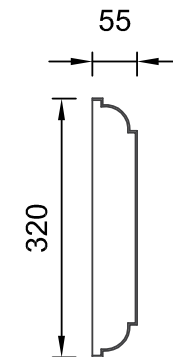

Art.Nr.: FFXCDN

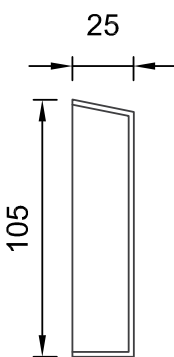

Art.Nr.: FFXCDS

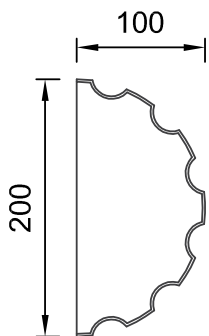

Art.Nr.: FFXCDG

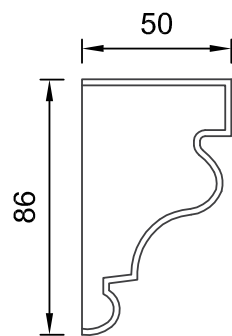

Art.Nr.: FFXCDK

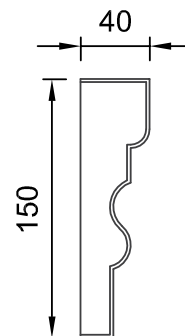

Art.Nr.: FFXCDP

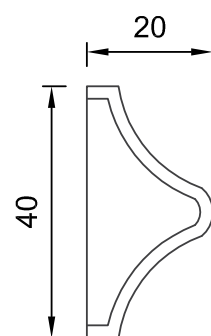

Art.Nr.: FFXCDT



QR-Code einfach scannen und
Austrotherm Materialisten-Generator
online nutzen.

Austrotherm Rahmenprofil

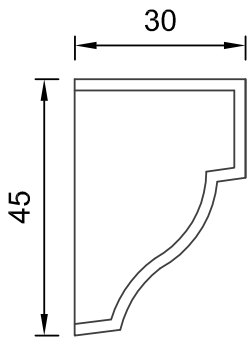

Art.Nr.: FFXCDU

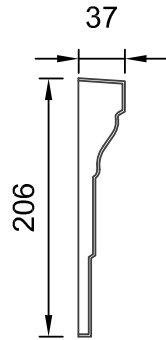

Art.Nr.: FFXCDZ

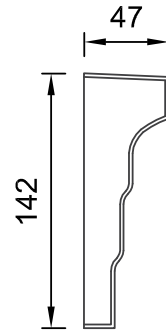

Art.Nr.: FFXCED

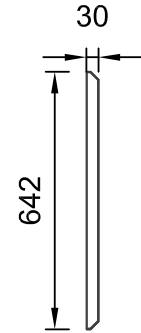

Art.Nr.: FFXCEH

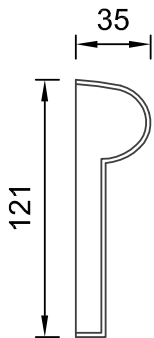

Art.Nr.: FFXCDW

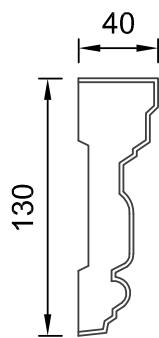

Art.Nr.: FFXCEA

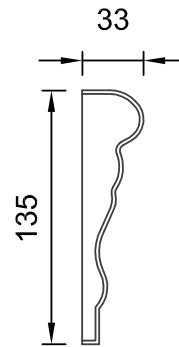

Art.Nr.: FFXCEE

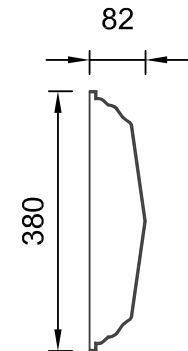

Art.Nr.: FFXCEI

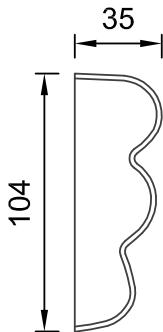

Art.Nr.: FFXCDX

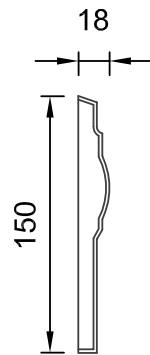

Art.Nr.: FFXCEB

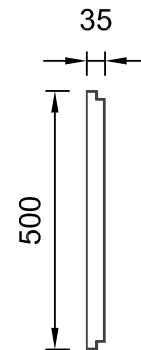

Art.Nr.: FFXCEF

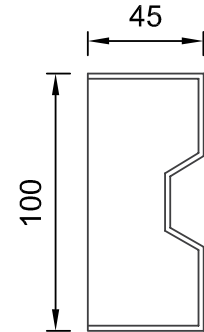

Art.Nr.: FFXCEJ

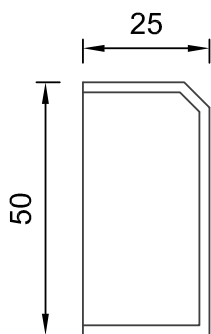

Art.Nr.: FFXCDY

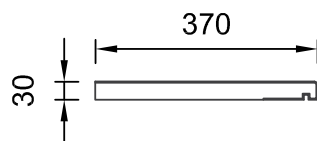

Art.Nr.: FFXCEC

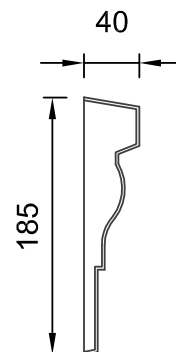

Art.Nr.: FFXCEG

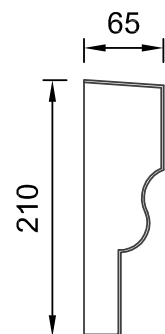

Art.Nr.: FFXCEK



QR-Code einfach scannen und
Austrotherm Materialisten-Generator
online nutzen.

Austrotherm Rahmenprofil

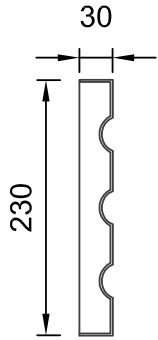

Art.Nr.: FFXCEL

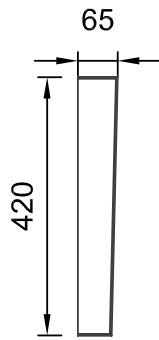

Art.Nr.: FFXCEP

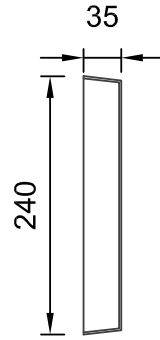

Art.Nr.: FFXCET

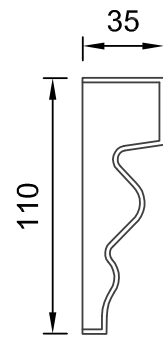

Art.Nr.: FFXCEX

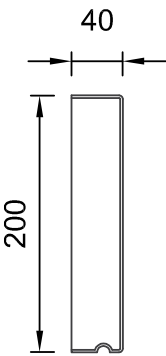

Art.Nr.: FFXCEM

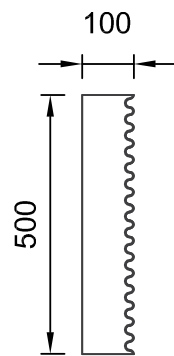

Art.Nr.: FFXCEQ

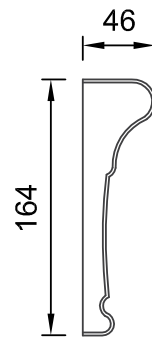

Art.Nr.: FFXCEU

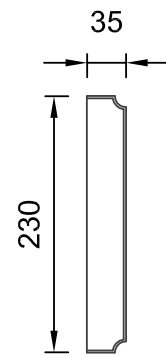

Art.Nr.: FFXCEY

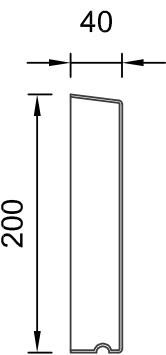

Art.Nr.: FFXCEN

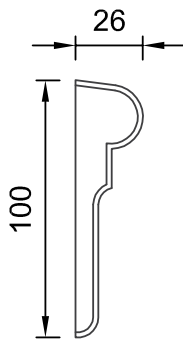

Art.Nr.: FFXCER

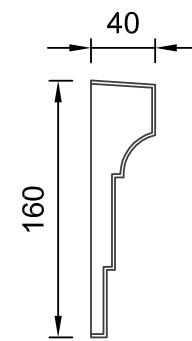

Art.Nr.: FFXCEV

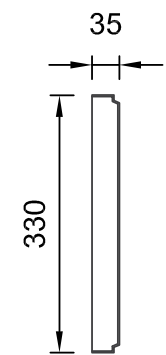

Art.Nr.: FFXCEZ

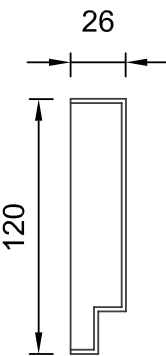

Art.Nr.: FFXCEO

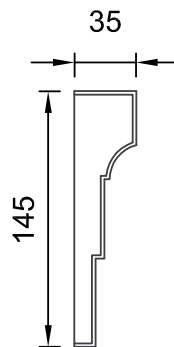

Art.Nr.: FFXCES

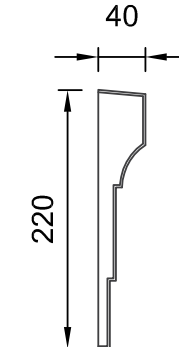

Art.Nr.: FFXCEW

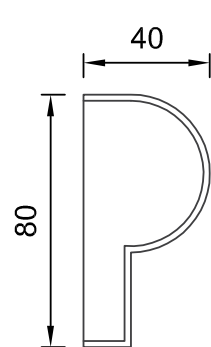

Art.Nr.: FFXCFA



QR-Code einfach scannen und
Austrotherm Materialisten-Generator
online nutzen.

Austrotherm Rahmenprofil

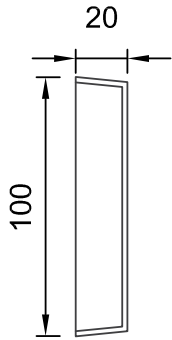

Art.Nr.: FFXCFB

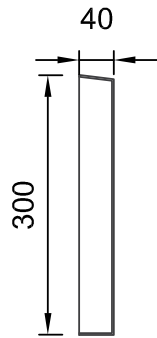

Art.Nr.: FFXCFF

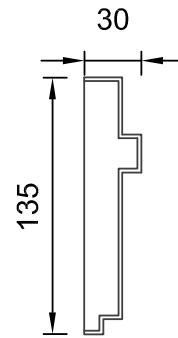

Art.Nr.: FFXCFJ

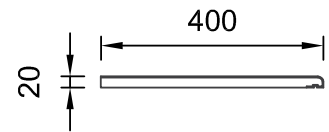

Art.Nr.: FFXCFN

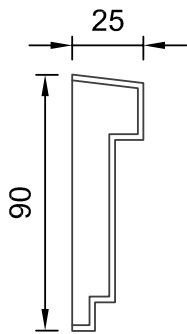

Art.Nr.: FFXCFC

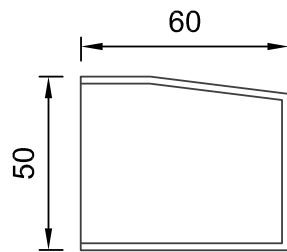

Art.Nr.: FFXCFG

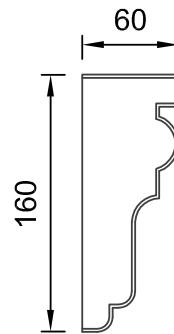

Art.Nr.: FFXCFK

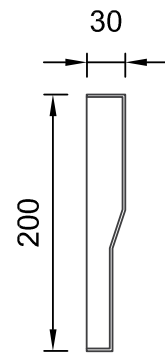

Art.Nr.: FFXCFO

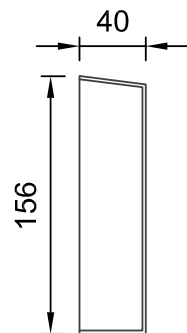

Art.Nr.: FFXCFD

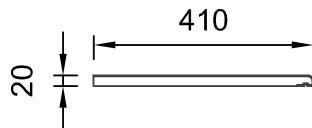

Art.Nr.: FFXCFH

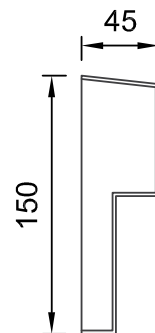

Art.Nr.: FFXCFL

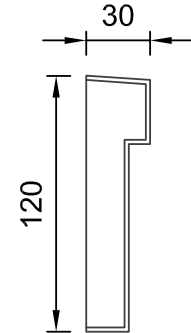

Art.Nr.: FFXCFP

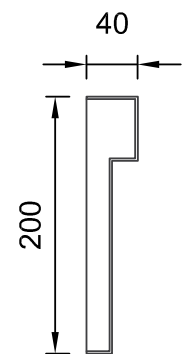

Art.Nr.: FFXCFE

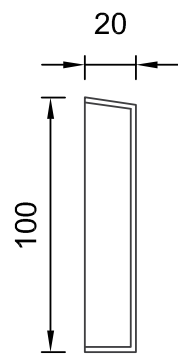

Art.Nr.: FFXCFI

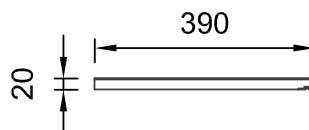

Art.Nr.: FFXCFM

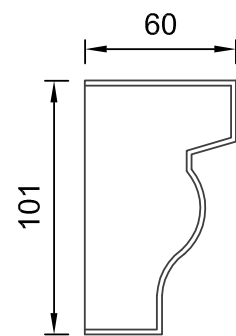

Art.Nr.: FFXCFQ



QR-Code einfach scannen und
Austrotherm Materialisten-Generator
online nutzen.

Austrotherm Rahmenprofil

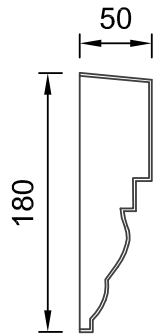

Art.Nr.: FFXCFR

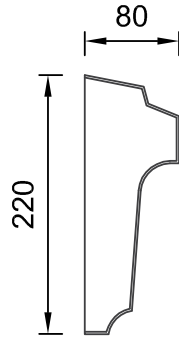

Art.Nr.: FFXCFV

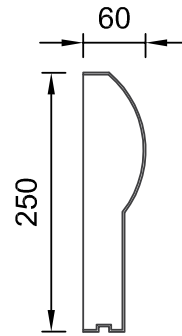

Art.Nr.: FFXCFZ

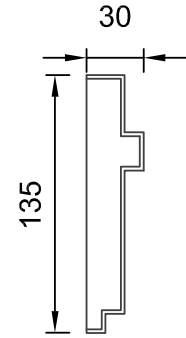

Art.Nr.: FFXCGD

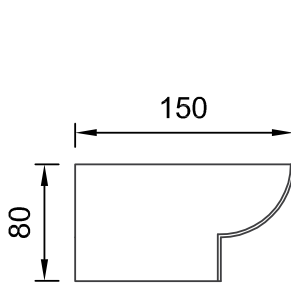

Art.Nr.: FFXCFS

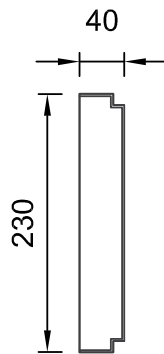

Art.Nr.: FFXCFW

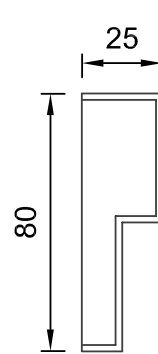

Art.Nr.: FFXCGA

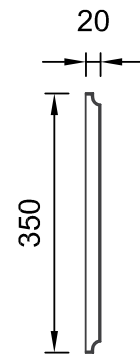

Art.Nr.: FFXCGE

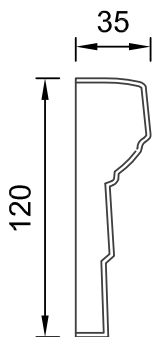

Art.Nr.: FFXCFT

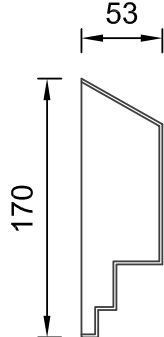

Art.Nr.: FFXCFWX

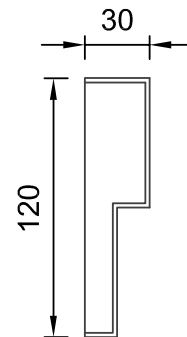

Art.Nr.: FFXCFGB

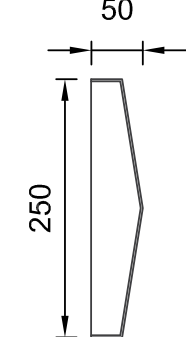

Art.Nr.: FFXCFGF

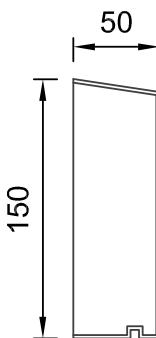

Art.Nr.: FFXCFU

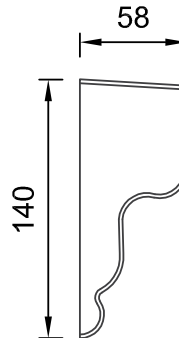

Art.Nr.: FFXCFY

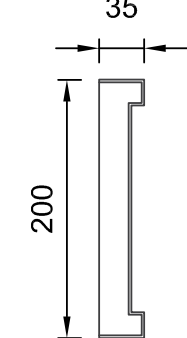

Art.Nr.: FFXCGC

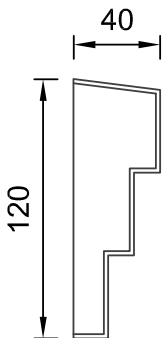

Art.Nr.: FFXCGG



QR-Code einfach scannen und
Austrotherm Materialisten-Generator
online nutzen.

Austrotherm Rahmenprofil

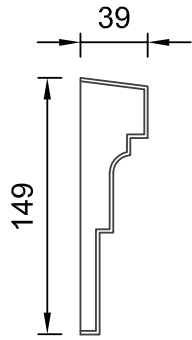

Art.Nr.: FFXCGH

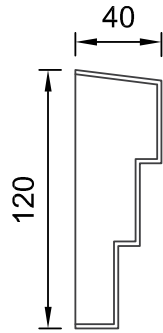

Art.Nr.: FFXCGL

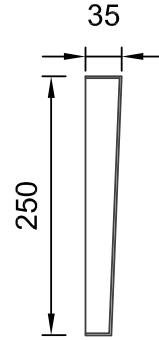

Art.Nr.: FFXCGQ

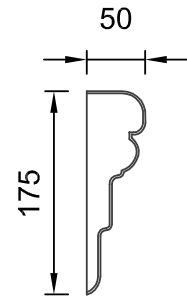

Art.Nr.: FFXCGU

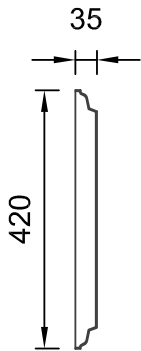

Art.Nr.: FFXCGI

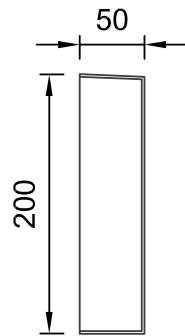

Art.Nr.: FFXCGM

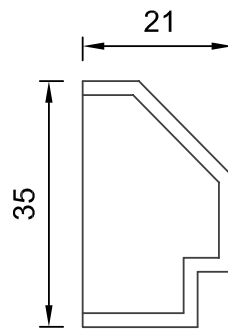

Art.Nr.: FFXCGR

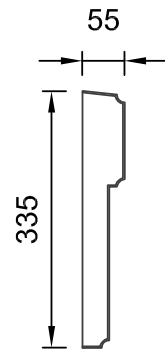

Art.Nr.: FFXCGV

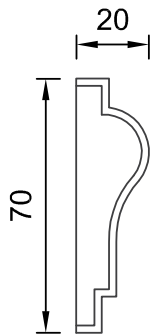

Art.Nr.: FFXCGJ

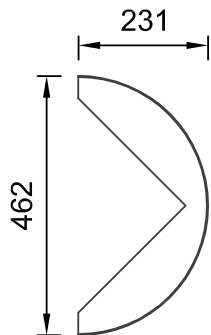

Art.Nr.: FFXCGN

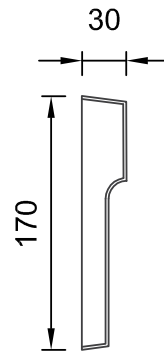

Art.Nr.: FFXCGS

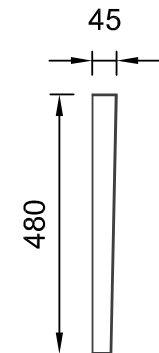

Art.Nr.: FFXCGX

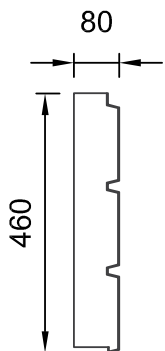

Art.Nr.: FFXCGK

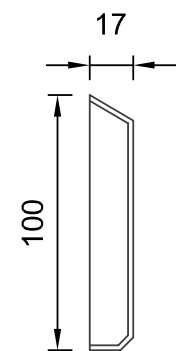

Art.Nr.: FFXCGO

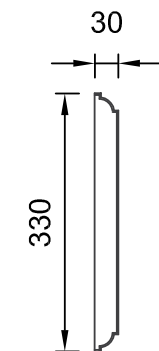

Art.Nr.: FFXCGT

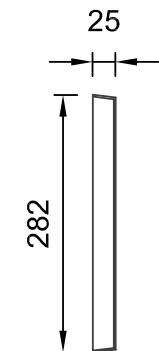

Art.Nr.: FFXCGY



QR-Code einfach scannen und
Austrotherm Materialisten-Generator
online nutzen.

Austrotherm Rahmenprofil

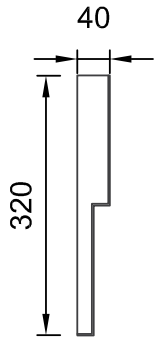

Art.Nr.: FFXCGZ

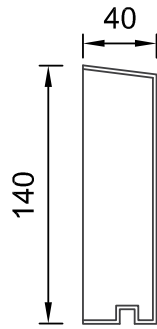

Art.Nr.: FFXCHG

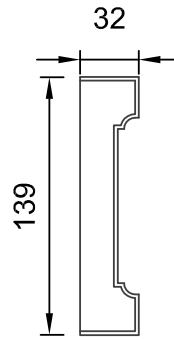

Art.Nr.: FFXCHM

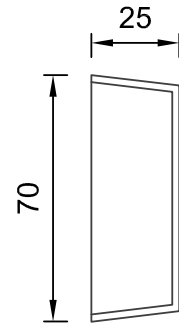

Art.Nr.: FFXCHR

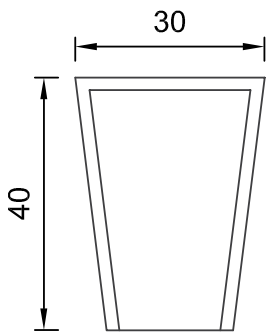

Art.Nr.: FFXCHA

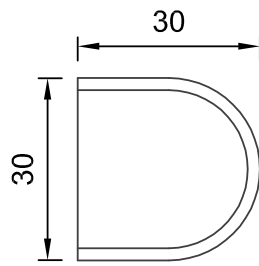

Art.Nr.: FFXCHI

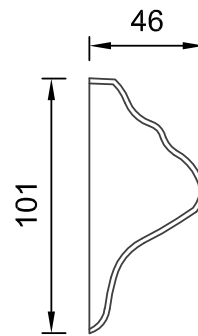

Art.Nr.: FFXCHO

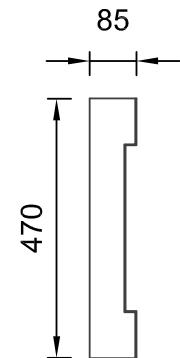

Art.Nr.: FFXCHS

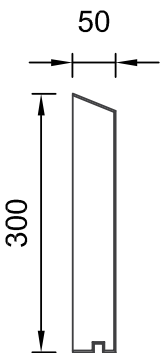

Art.Nr.: FFXCHB

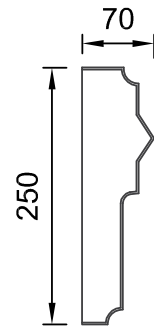

Art.Nr.: FFXCHK

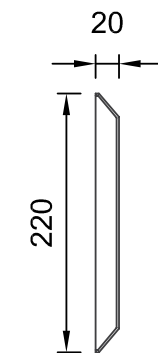

Art.Nr.: FFXCHP

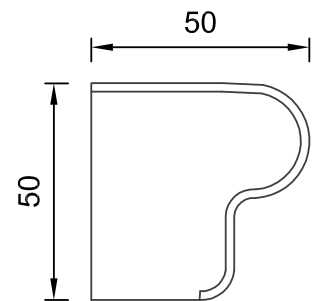

Art.Nr.: FFXCHT

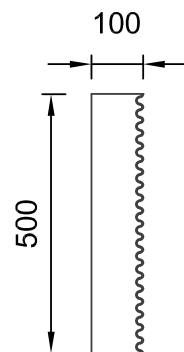

Art.Nr.: FFXCHE

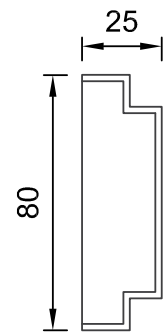

Art.Nr.: FFXCHL

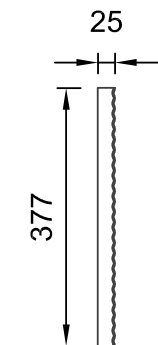

Art.Nr.: FFXCHQ

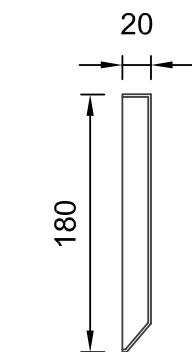

Art.Nr.: FFXCHU



QR-Code einfach scannen und
Austrotherm Materialisten-Generator
online nutzen.

Austrotherm Rahmenprofil

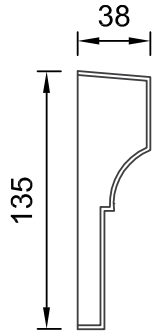

Art.Nr.: FFXCHV

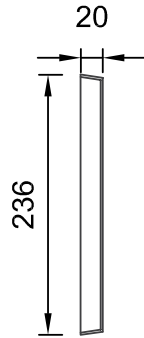

Art.Nr.: FFXCHZ

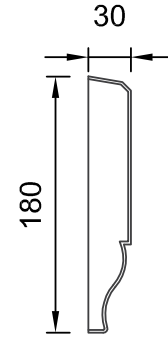

Art.Nr.: FFXCIE

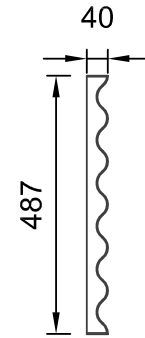

Art.Nr.: FFXCII

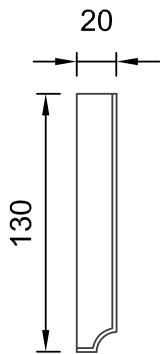

Art.Nr.: FFXCHW

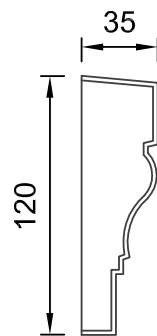

Art.Nr.: FFXCIB

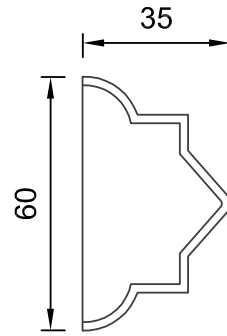

Art.Nr.: FFXCIF

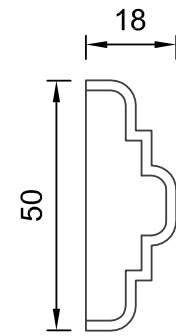

Art.Nr.: FFXCIJ

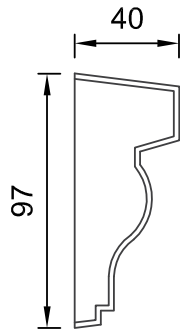

Art.Nr.: FFXCHX

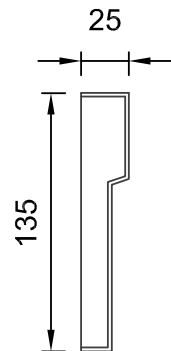

Art.Nr.: FFXCIC

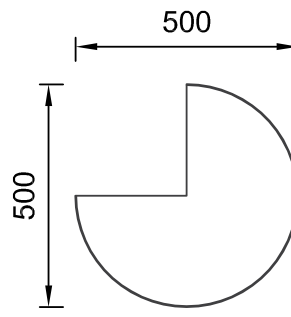

Art.Nr.: FFXCIG

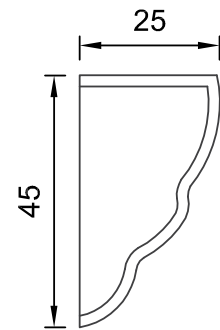

Art.Nr.: FFXCIK

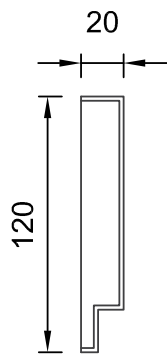

Art.Nr.: FFXCHY

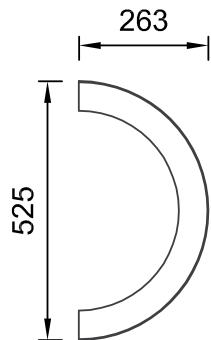

Art.Nr.: FFXCID

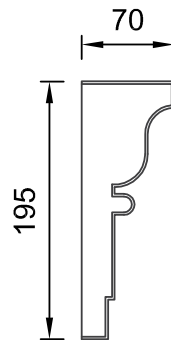

Art.Nr.: FFXCIH

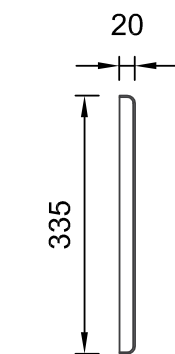

Art.Nr.: FFXCIL



QR-Code einfach scannen und
Austrotherm Materialisten-Generator
online nutzen.

Austrotherm Rahmenprofil

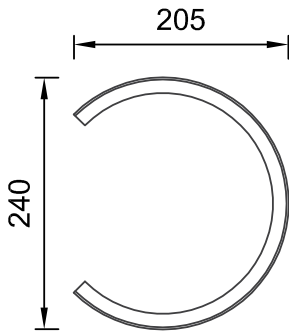

Art.Nr.: FFXCIM

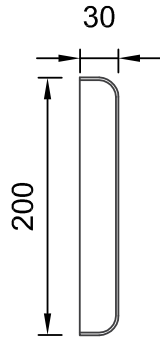

Art.Nr.: FFXCIR

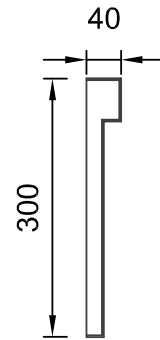

Art.Nr.: FFXCIV

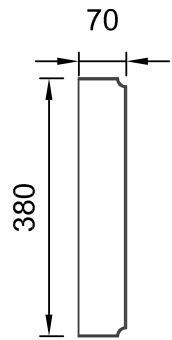

Art.Nr.: FFXCJA

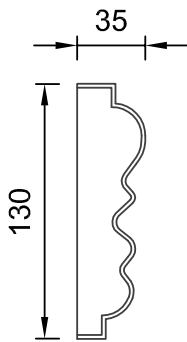

Art.Nr.: FFXCIN

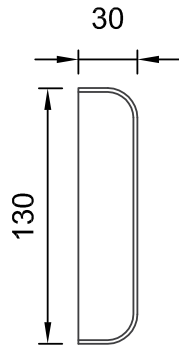

Art.Nr.: FFXCIS

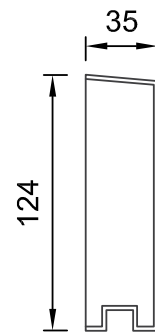

Art.Nr.: FFXCIW

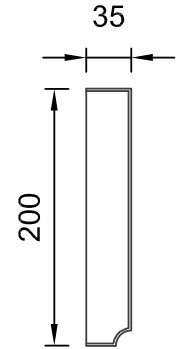

Art.Nr.: FFXCJB

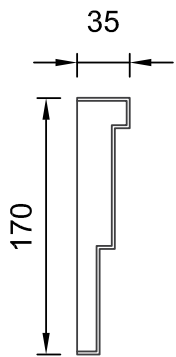

Art.Nr.: FFXCIO

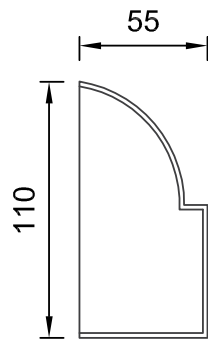

Art.Nr.: FFXCIT

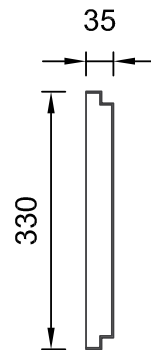

Art.Nr.: FFXCIY

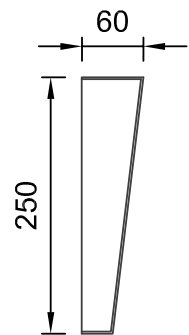

Art.Nr.: FFXCJC

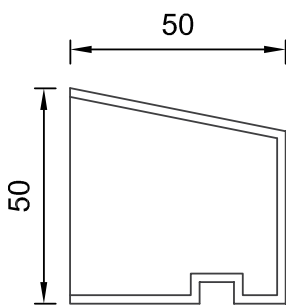

Art.Nr.: FFXCIQ

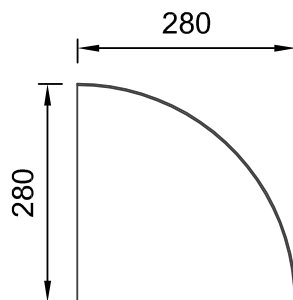

Art.Nr.: FFXCIU

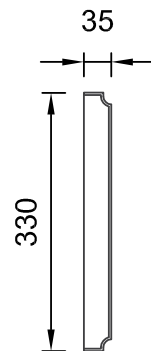

Art.Nr.: FFXCIZ

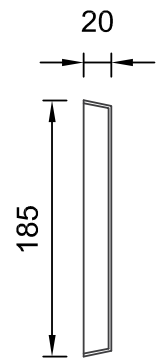

Art.Nr.: FFXCJD



QR-Code einfach scannen und
Austrotherm Materialisten-Generator
online nutzen.

Austrotherm Rahmenprofil

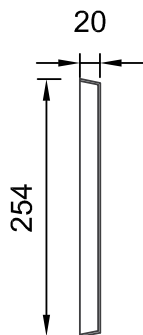

Art.Nr.: FFXCJE

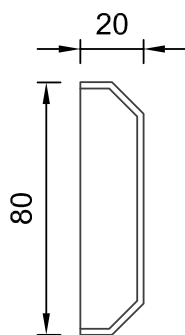

Art.Nr.: FFXCJI

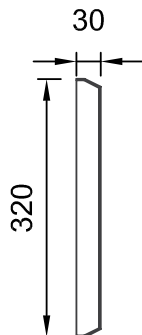

Art.Nr.: FFXCJN

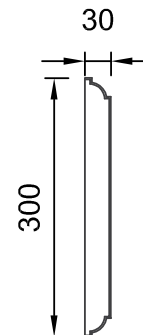

Art.Nr.: FFXCJS

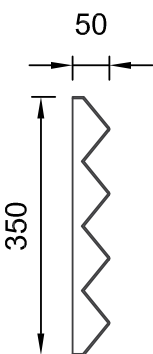

Art.Nr.: FFXCJF

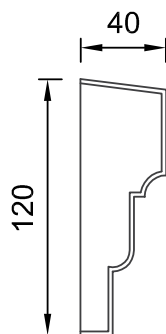

Art.Nr.: FFXCJJ

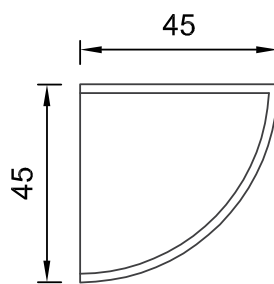

Art.Nr.: FFXCJO

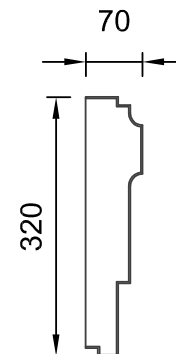

Art.Nr.: FFXCJT

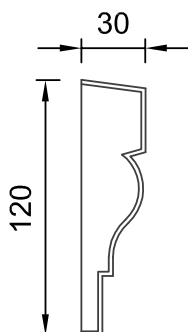

Art.Nr.: FFXCJG

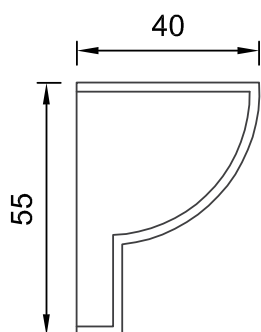

Art.Nr.: FFXCJK

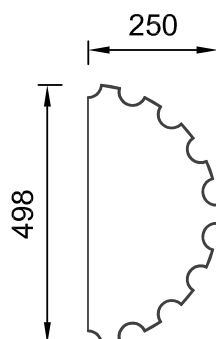

Art.Nr.: FFXCJP

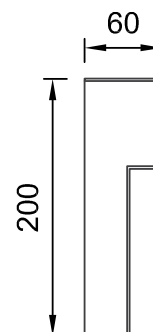

Art.Nr.: FFXCJU

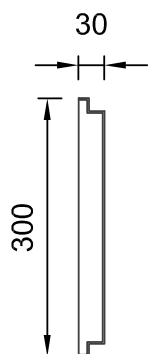

Art.Nr.: FFXCJH

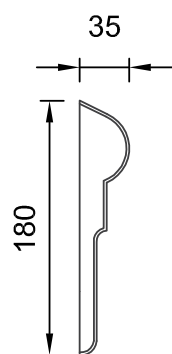

Art.Nr.: FFXCJM

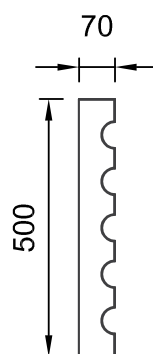

Art.Nr.: FFXCJQ

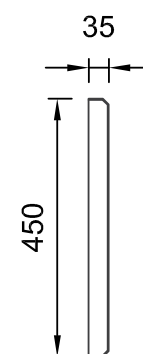

Art.Nr.: FFXCJW



QR-Code einfach scannen und
Austrotherm Materialisten-Generator
online nutzen.

Austrotherm Rahmenprofil

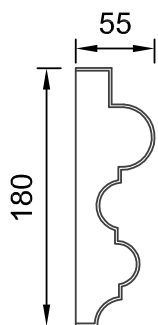

Art.Nr.: FFXCJX

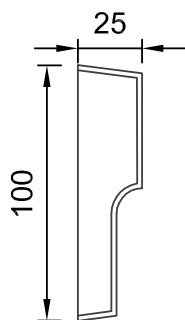

Art.Nr.: FFXCKD

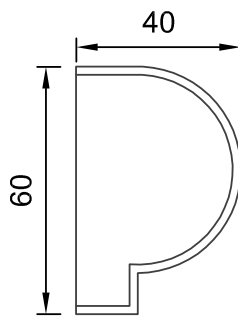

Art.Nr.: FFXCKI

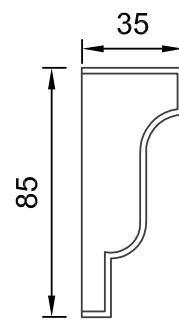

Art.Nr.: FFXCKM

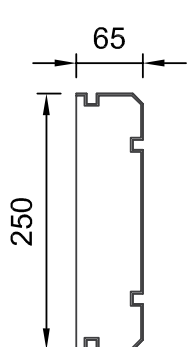

Art.Nr.: FFXCKA

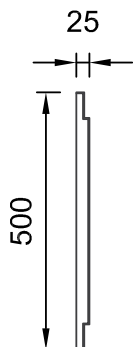

Art.Nr.: FFXCKE

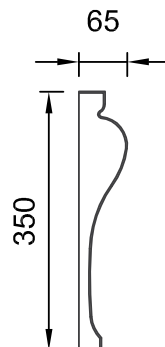

Art.Nr.: FFXCKJ

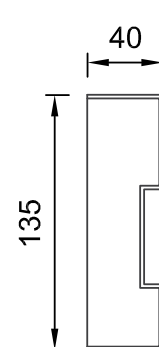

Art.Nr.: FFXCKN

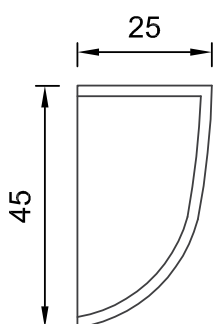

Art.Nr.: FFXCKB

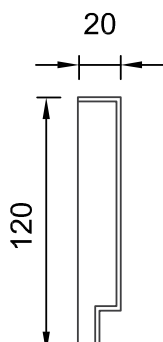

Art.Nr.: FFXCKF

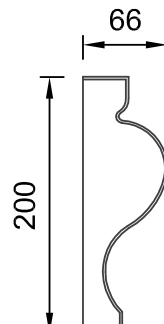

Art.Nr.: FFXCKK

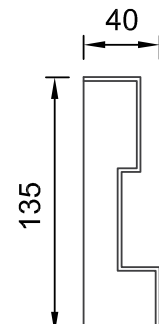

Art.Nr.: FFXCKO

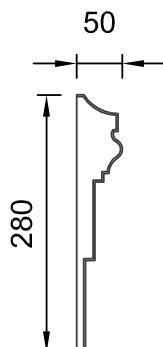

Art.Nr.: FFXCKC

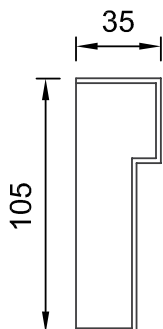

Art.Nr.: FFXCKH

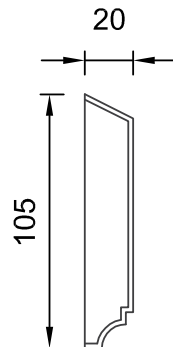

Art.Nr.: FFXCKL

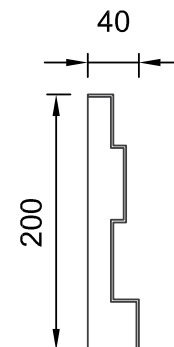

Art.Nr.: FFXCKP



QR-Code einfach scannen und
Austrotherm Materiallisten-Generator
online nutzen.

Austrotherm Rahmenprofil

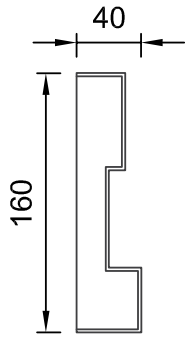

Art.Nr.: FFXCKQ

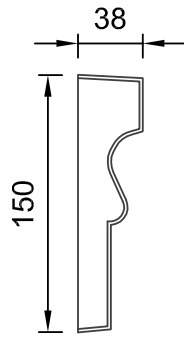

Art.Nr.: FFXCKU

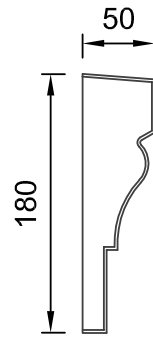

Art.Nr.: FFXCKY

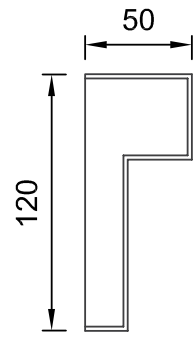

Art.Nr.: FFXCLC

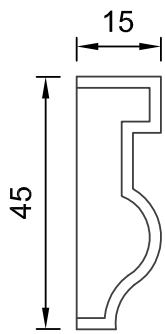

Art.Nr.: FFXCKR

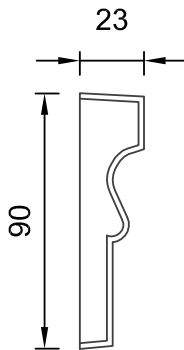

Art.Nr.: FFXCKV

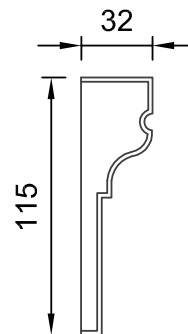

Art.Nr.: FFXCKZ

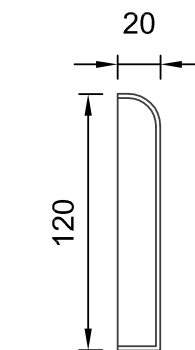

Art.Nr.: FFXCLD

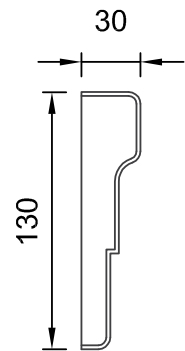

Art.Nr.: FFXCKS

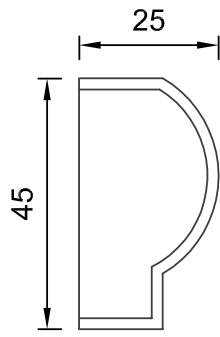

Art.Nr.: FFXCKW

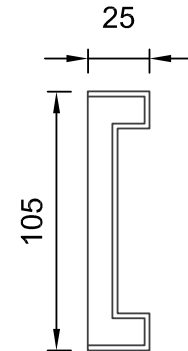

Art.Nr.: FFXCLA

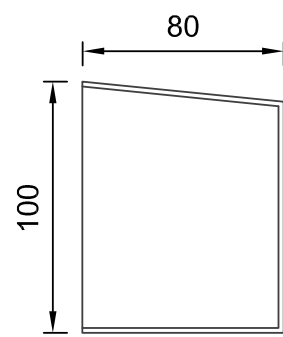

Art.Nr.: FFXCLF

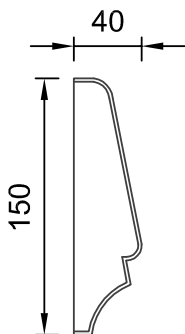

Art.Nr.: FFXCKT

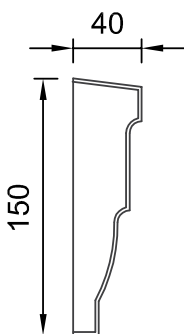

Art.Nr.: FFXCKX

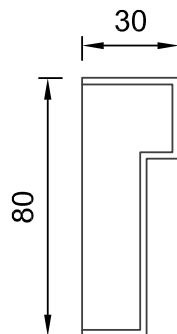

Art.Nr.: FFXCLB

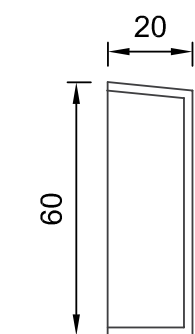

Art.Nr.: FFXCLG



QR-Code einfach scannen und
Austrotherm Materialisten-Generator
online nutzen.

Austrotherm Rahmenprofil

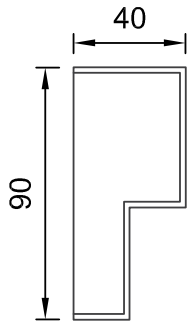

Art.Nr.: FFXCLJ

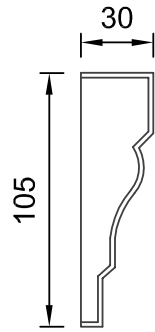

Art.Nr.: FFXCLN

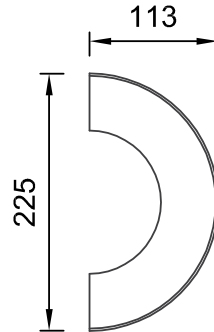

Art.Nr.: FFXCLS

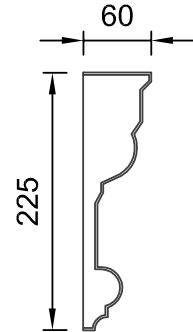

Art.Nr.: FFXCLX

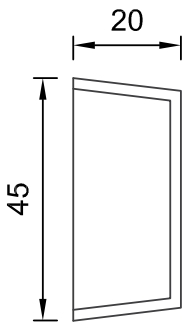

Art.Nr.: FFXCLK

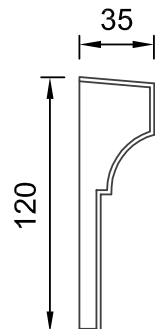

Art.Nr.: FFXCLO

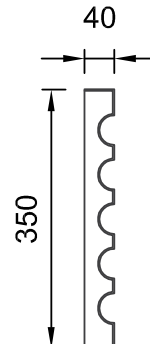

Art.Nr.: FFXCLU

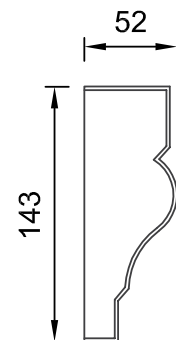

Art.Nr.: FFXCLY

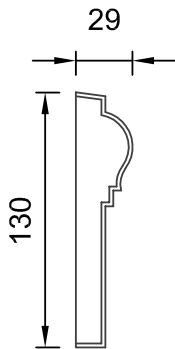

Art.Nr.: FFXCLL

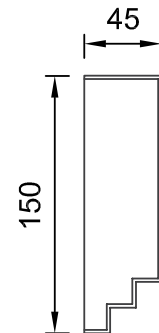

Art.Nr.: FFXCLQ

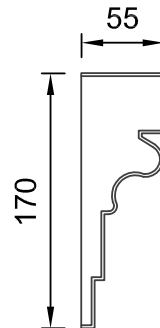

Art.Nr.: FFXCLV

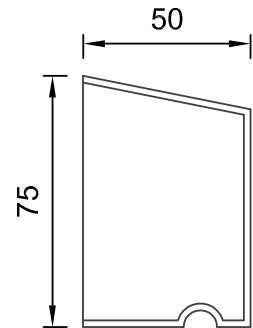

Art.Nr.: FFXCLZ

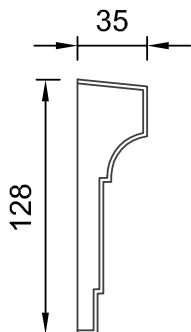

Art.Nr.: FFXCLM

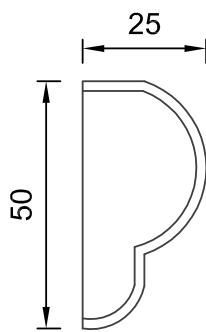

Art.Nr.: FFXCLR

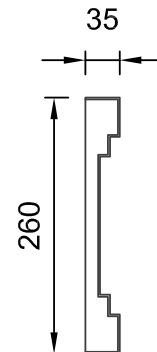

Art.Nr.: FFXCLW

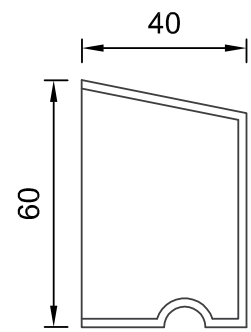

Art.Nr.: FFXCMA



QR-Code einfach scannen und
Austrotherm Materialisten-Generator
online nutzen.

Austrotherm Rahmenprofil

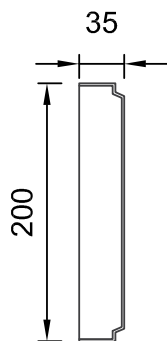

Art.Nr.: FFXCMB

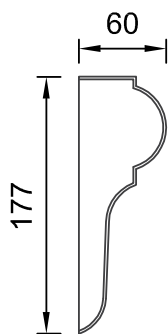

Art.Nr.: FFXCMG

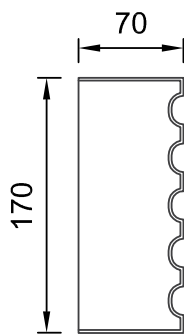

Art.Nr.: FFXCMK

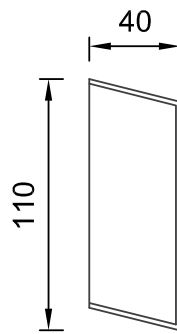

Art.Nr.: FFXCMP

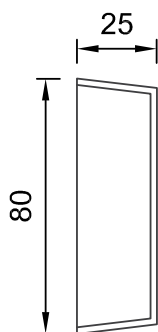

Art.Nr.: FFXCMC

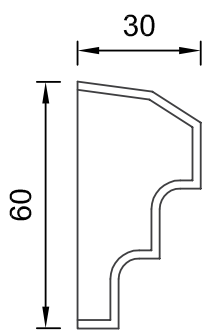

Art.Nr.: FFXCMH

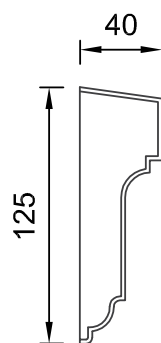

Art.Nr.: FFXCML

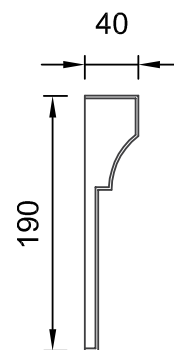

Art.Nr.: FFXCMQ

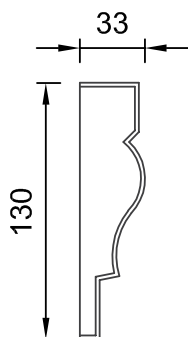

Art.Nr.: FFXCMD

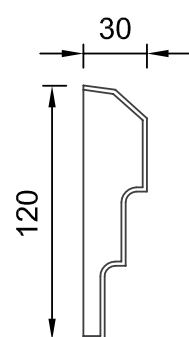

Art.Nr.: FFXCMI

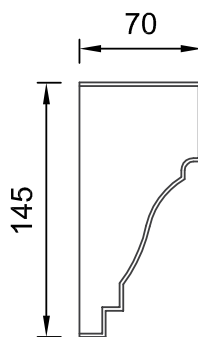

Art.Nr.: FFXCMM

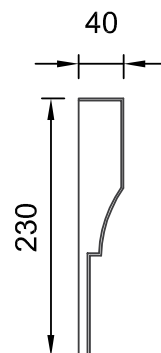

Art.Nr.: FFXCMR

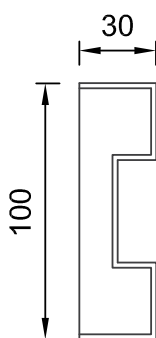

Art.Nr.: FFXCME

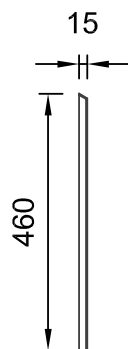

Art.Nr.: FFXCMJ

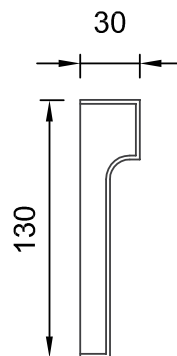

Art.Nr.: FFXCMN

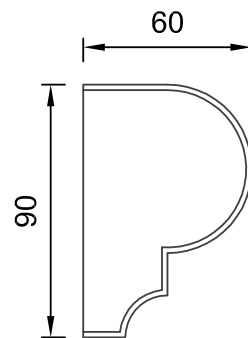

Art.Nr.: FFXCMS



QR-Code einfach scannen und
Austrotherm Materialisten-Generator
online nutzen.

Austrotherm Rahmenprofil

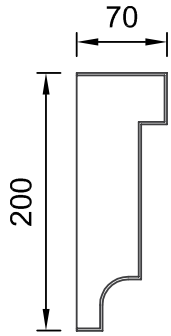

Art.Nr.: FFXCMU

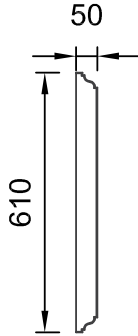

Art.Nr.: FFXCNA

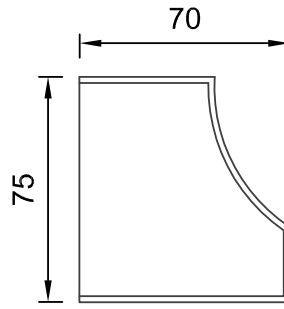

Art.Nr.: FFXCNE

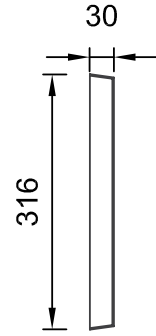

Art.Nr.: FFXCNI

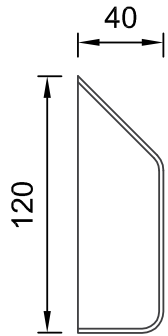

Art.Nr.: FFXCMV

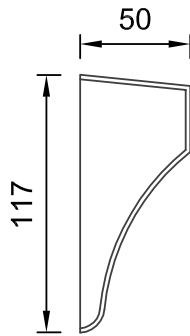

Art.Nr.: FFXCNB

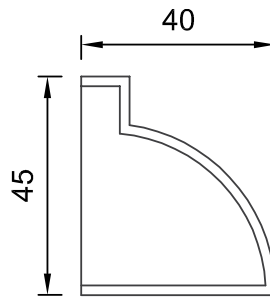

Art.Nr.: FFXCNF

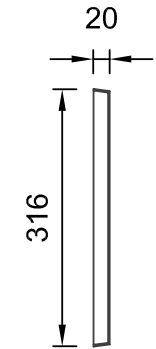

Art.Nr.: FFXCNJ

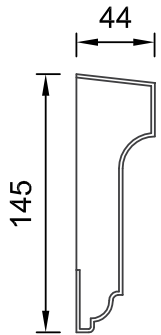

Art.Nr.: FFXCMW

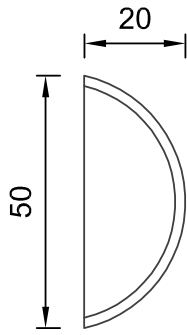

Art.Nr.: FFXCNC

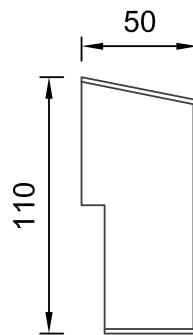

Art.Nr.: FFXCNG

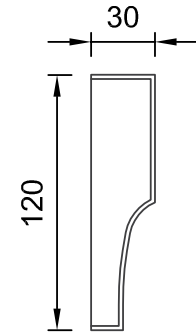

Art.Nr.: FFXCNK

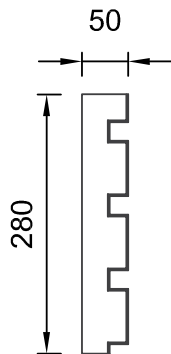

Art.Nr.: FFXCMZ

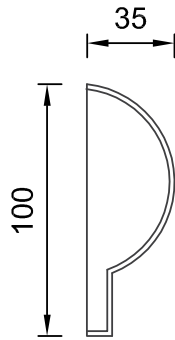

Art.Nr.: FFXCND

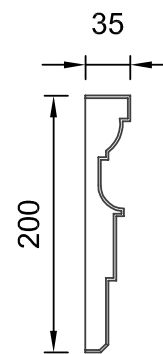

Art.Nr.: FFXCNH

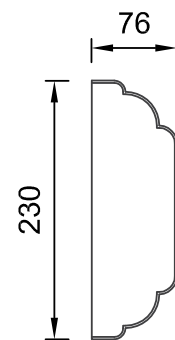

Art.Nr.: FFXCNM



QR-Code einfach scannen und
Austrotherm Materialisten-Generator
online nutzen.

Austrotherm Rahmenprofil

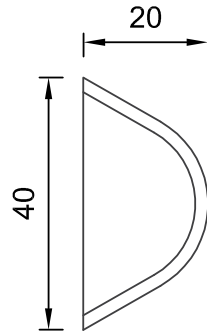

Art.Nr.: FFXCNN

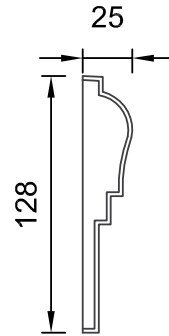

Art.Nr.: FFXCNS

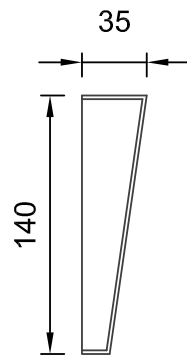

Art.Nr.: FFXCNP

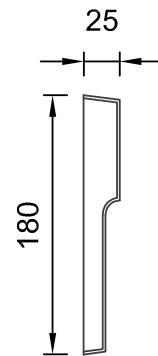

Art.Nr.: FFXCNT

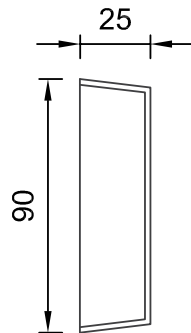

Art.Nr.: FFXCNQ

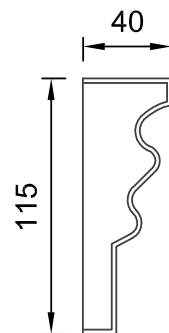

Art.Nr.: FFXCNU

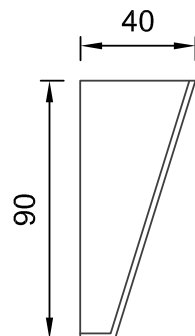

Art.Nr.: FFXCNR

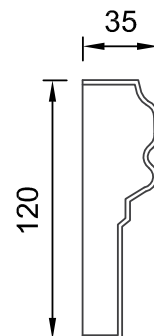

Art.Nr.: FFXCNV



QR-Code einfach scannen und
Austrotherm Materialisten-Generator
online nutzen.

